

# User Manual

## TB-WH TB-CH

The color and the appearance may differ depending on the product, and the specifications are subject to change without prior notice to improve the performance.

# Table Of Contents

---

<b>BEFORE USING THE PRODUCT</b>	<b>5</b>	<b>Copyright</b>
	5	Icons used in this manual
	5	Symbols for safety precautions
	<b>6</b>	<b>Safety Precautions</b>
	6	Electricity and Safety
	7	Installation and Safety
	9	Operation and Safety
<b>PREPARATIONS</b>	<b>13</b>	<b>Checking the Contents</b>
	13	Removing the Packaging
	14	Checking the Components
	<b>15</b>	<b>Parts</b>
	15	Button
	16	Reverse Side
	17	Right Side View
	<b>18</b>	<b>Installation</b>
	18	Reassembly
	20	Adjusting the Product Height
	21	Anti-theft Lock
<b>USING "WINDOWS EMBEDDED STANDARD 7" (TB-WH)</b>	<b>22</b>	<b>What is "Windows Embedded Standard 7" Client?</b>
	<b>23</b>	<b>Connection to Use "Windows Embedded Standard 7"</b>
	23	Before Connecting
	24	Connection Using the D-SUB Cable (Analogue Type)
	24	Connection Using the DVI Cable
	25	Connecting a Microphone
	25	Connecting to Headphones or Speakers
	26	LAN Connection
	26	Connecting USB Devices
	27	Connecting the Power

# Table Of Contents

---

	<b>28</b>	<b>Using "Windows Embedded Standard 7"</b>
	28	Logon
	28	"Windows Embedded Standard 7" Desktop
	29	Programs
	36	Configuring Utilities
	37	Recover the System
	<b>38</b>	<b>MagicRMS Pro</b>
	38	About <b>MagicRMS Pro</b>
<b>USING THE "ZERO CLIENT" (TB-CH)</b>	<b>39</b>	<b>About "Zero Client"</b>
	<b>40</b>	<b>Connection to Use the "Zero Client"</b>
	40	Before Connecting
	41	Connection Using the D-SUB Cable (Analogue Type)
	41	Connection Using the DVI Cable
	42	Connecting a Microphone
	42	Connecting to Headphones or Speakers
	43	Connecting to a Server (LAN/USB Connection)
	44	Connecting the Power
	<b>45</b>	<b>Using the "Zero Client"</b>
	45	Login
	45	Message Box
	46	Toolbar
<b>TROUBLESHOOTING GUIDE</b>	<b>69</b>	<b>Requirements Before Contacting Samsung Customer Service Center</b>
	69	Check the following.
<b>SPECIFICATIONS</b>	<b>70</b>	<b>General</b>
	<b>71</b>	<b>Power consumption</b>
<b>APPENDIX</b>	<b>72</b>	<b>Contact SAMSUNG WORLDWIDE</b>

# Table Of Contents

---

77	<b>Correct Disposal</b>
77	Correct Disposal of This Product (Waste Electrical & Electronic Equipment)
77	Correct disposal of batteries in this product

## INDEX

# Before Using the Product

## Copyright

The contents of this manual are subject to change without notice to improve quality.

© 2012 Samsung Electronics

Samsung Electronics owns the copyright for this manual.

Use or reproduction of this manual in parts or entirety without the authorization of Samsung Electronics is prohibited.

The SAMSUNG logo is a registered trademark of Samsung Electronics.

Microsoft and Windows are registered trademarks of Microsoft Corporation.

VESA, DPM and DDC are registered trademarks of the Video Electronics Standards Association.





- An administration fee may be charged if either
  - (a) an engineer is called out at your request and there is no defect in the product (i.e. where you have failed to read this user manual).
  - (b) you bring the unit to a repair centre and there is no defect in the product (i.e. where you have failed to read this user manual).
- The amount of such administration charge will be advised to you before any work or home visit is carried out.

## Icons used in this manual



The following images are for reference only. Real-life situations may differ from what is shown in the images.

## Symbols for safety precautions

 Warning	A serious or fatal injury may result if instructions are not followed.
 Caution	Personal injury or damage to properties may result if instructions are not followed.
	Activities marked by this symbol are prohibited.
	Instructions marked by this symbol must be followed.

# Before Using the Product

## Safety Precautions

 The monitor images in this manual are for reference only. Monitor is sold separately.

### Electricity and Safety

#### Warning



Do not use a damaged power cable or plug, or a loose power socket.

- An electric shock or fire may result.

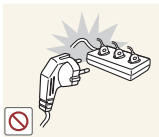

Do not plug many products into the same power socket.

- Otherwise, the socket may overheat and cause a fire.



Do not touch the power cable with wet hands.

- Otherwise, an electric shock may result.

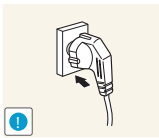

Insert the power cable all the way in so it is not loose.

- An unstable connection may cause a fire.

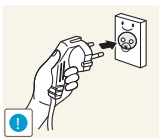

Ensure you connect the power cable to a grounded power socket. (type 1 insulated devices only).

- An electric shock or injury may result.

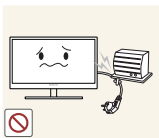

Do not bend or pull the power cable with force. Do not weigh the power cable down with a heavy object.

- A damaged power cord may cause an electric shock or fire.



Do not place the power cable or product near heat sources.

- An electric shock or fire may result.



If the power cable pins or power outlet is covered with a foreign substance (dust, etc.), wipe it off using a dry cloth.

- Otherwise, a fire may result.

# Before Using the Product

## Caution

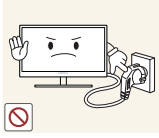

Do not unplug the power cable when the product is in use.

- The product may become damaged by an electric shock.

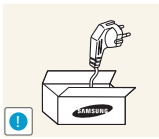

Do not use the power cable for products other than authorized products supplied by Samsung.

- An electric shock or fire may result.

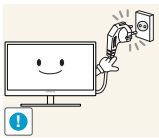

Keep the power socket where the power cable is connected unobstructed.

- If any problem occurs in the product, unplug the power cable to completely cut the power to the product.

Power to the product cannot be completely cut off with the power switch.

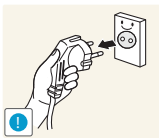

Hold the plug when disconnecting the power cable from the power socket.

- An electric shock or fire may result.

## Installation and Safety

## Warning



DO NOT PLACE CANDLES, INSECT REPELLANTS OR CIGARETTES ON TOP OF THE PRODUCT. DO NOT INSTALL THE PRODUCT NEAR HEAT SOURCES.

- Otherwise, a fire may result.



Avoid installing the product in a narrow space with bad ventilation, such as a bookshelf or wall closet.

- Otherwise, a fire may result due to an increased internal temperature.



Keep the plastic packaging bag for the product in a place that cannot be reached by children.

- Children may suffocate.

# Before Using the Product

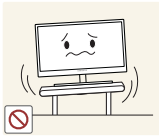

Do not install the product on an unstable or vibrating surface (insecure shelf, sloped surface, etc.).

- The product may fall and break or cause a personal injury.
- Using the product in an area with excess vibration may damage the product or cause a fire.



Do not install the product in a vehicle or a place exposed to dust, moisture (water drips, etc.), oil, or smoke.

- An electric shock or fire may result.



Do not expose the product to direct sunlight, heat, or a hot object such as a stove.

- Otherwise, the product lifespan may be reduced, or a fire may result.



Do not install the product within the reach of young children.

- The product may fall and injure children.



Edible oil, such as soybean oil, can damage or deform the product. Do not install the product in a kitchen or near a kitchen counter.

## **Caution**

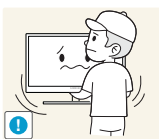

Take care not to drop the product when moving it.

- Otherwise, product failure or personal injury may result.



When installing the product on a cabinet or shelf, make sure that the bottom edge of the front of the product is not protruding.

- The product may fall and break or cause a personal injury.
- Install the product only on cabinets or shelves of the right size.



# Before Using the Product

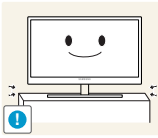

Put down the product carefully.

- The product may fall and break or cause a personal injury.



Installing the product in an unusual place (a place exposed to a lot of fine particles, chemical substances or extreme temperatures, or an airport or train station where the product should operate continuously for an extended period of time) may seriously affect its performance.

- Be sure to consult Samsung Customer Service Center (page 72) before installation if you want to install the product at such a place.

## Operation and Safety

### Warning



High voltage runs through the product. Do not attempt to disassemble, repair, or modify the product on your own.

- An electric shock or fire may result.
- Contact Samsung Customer Service Center (page 72) for repair.

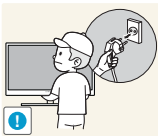

Before moving the product, turn off the power switch and disconnect the power cable and all other connected cables.

- Otherwise, the power cord may be damaged and a fire or electric shock may result.

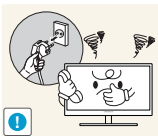

If the product generates a strange noise, a burning smell, or smoke, remove the power cable immediately and contact Samsung Customer Service Center (page 72).

- An electric shock or fire may result.

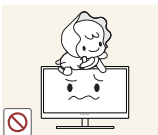

Do not let children hang from the product or climb on top of it.

- The product may fall, and your child may become injured or seriously harmed.



If the product falls or the exterior is damaged, power off the product, remove the power cable, and contact Samsung Customer Service Center (page 72).

- Otherwise, an electric shock or fire may result.

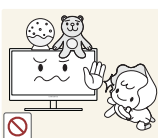

Do not put a heavy object, toy, or sweets on top of the product.

- The product or heavy objects may fall as children try to reach for the toy or sweets resulting in a serious injury.

# Before Using the Product



Do not drop objects on the product or apply impact.

- An electric shock or fire may result.



Do not move the product by pulling the power cable or any cable.

- Otherwise, the cable may be damaged and product failure, an electric shock or fire may result.

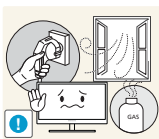

If a gas leakage is found, do not touch the product or power cable. Also, ventilate the area immediately.

- Sparks can cause an explosion or fire.

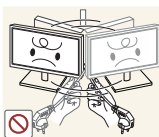

Do not lift or move the product by pulling the power cable or any cable.

- Otherwise, the cable may be damaged and product failure, an electric shock or fire may result.

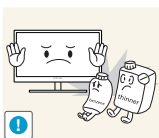

Do not use or keep combustible spray or an inflammable substance near the product.

- An explosion or fire may result.



Ensure the vents are not blocked by tablecloths or curtains.

- Otherwise, a fire may result from an increased internal temperature.

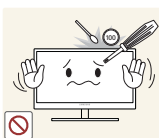

Do not insert a metallic object (a chopstick, coin, hair pin, etc.) or inflammable object (paper, match, etc.) into the vent or ports of the product.

- If water or any foreign substance enters the product, be sure to power off the product, remove the power cable, and contact Samsung Customer Service Center (page 72).
- Product failure, an electric shock or fire may result.



Do not place objects containing liquid (vases, pots, bottles, etc) or metallic objects on top of the product.

- If water or any foreign substance enters the product, be sure to power off the product, remove the power cable, and contact Samsung Customer Service Center (page 72).
- Product failure, an electric shock or fire may result.

# Before Using the Product

## Caution

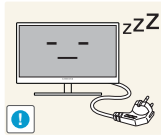

Disconnect the power cable from the power socket if you do not plan on using the product for an extended period of time (vacation, etc.).

- Otherwise, a fire may result from accumulated dust, overheating, an electric shock, or electric leakage.

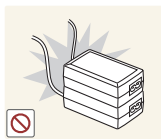

Do not put DC power adapters together.

- Otherwise, a fire may result.

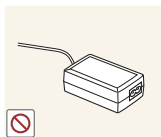

Remove the plastic bag from the DC power adapter before you use it.

- Otherwise, a fire may result.



Do not let water enter the DC power adapter or get the adapter wet.

- An electric shock or fire may result.
- Avoid using the product outdoors where it can be exposed to rain or snow.
- Be careful not to get the DC power adapter wet when you wash the floor.



Do not put the DC power adapter near to any heating apparatus.

- Otherwise, a fire may result.

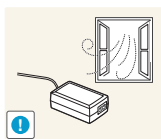

Keep the DC power adapter in a well-ventilated area.



Do not use humidifiers or stoves around the product.

- An electric shock or fire may result.

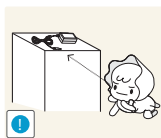

Store the small accessories used with the product out of reach of children.

# Before Using the Product

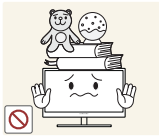

Do not place heavy objects on the product.

- Product failure or personal injury may result.



Do not increase the volume too high when using headphones (earphones).

- Sound particularly at a higher volume could potentially affect long-term hearing.

## 1.1 Checking the Contents

### 1.1.1 Removing the Packaging

- 1 Open the packaging box. Be careful not to damage the product when you open the packaging with a sharp instrument.

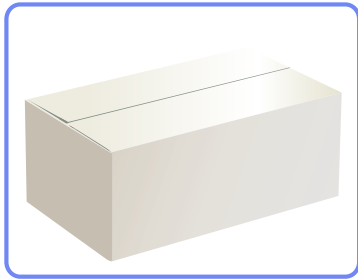

- 2 Remove the styrofoam from the product.

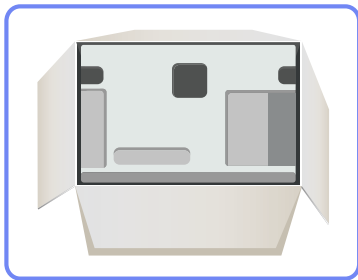

- 3 Check the components and remove the styrofoam and plastic bag.
  - The appearance of actual components may differ from the image shown.
  - This image is for reference only.
- 4 Store the box in a dry area so that it can be used when moving the product in the future.

## 1.1.2 Checking the Components



- Contact the dealer from whom you purchased the product if any item is missing.
- The appearance of the components and items sold separately may differ from the image shown.

### Components

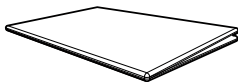

Quick setup guide



Warranty card  
(Not available in some locations)

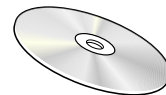

User manual

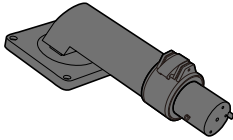

Stand connector

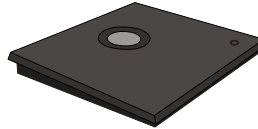

Stand base

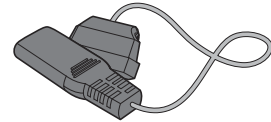

Power cable



DC power adapter



- Components may vary depending on the country.
- The stand base supplied with this product contains a circuit board. Care should be taken when handling the base.

### Items sold separately



The following items can be purchased at your nearest retailer.

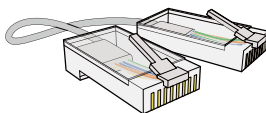

LAN cable

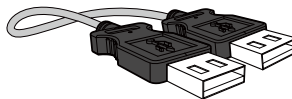

USB cable

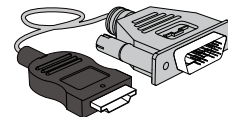

HDMI-DVI cable

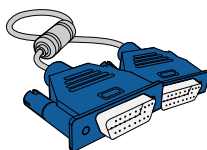

D-SUB cable

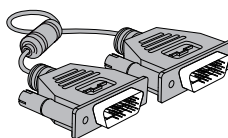

DVI cable

## 1.2 Parts

### 1.2.1 Button



The color and shape of parts may differ from what is shown. Specifications are subject to change without notice to improve quality.

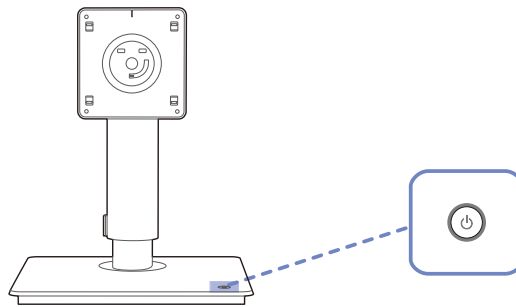





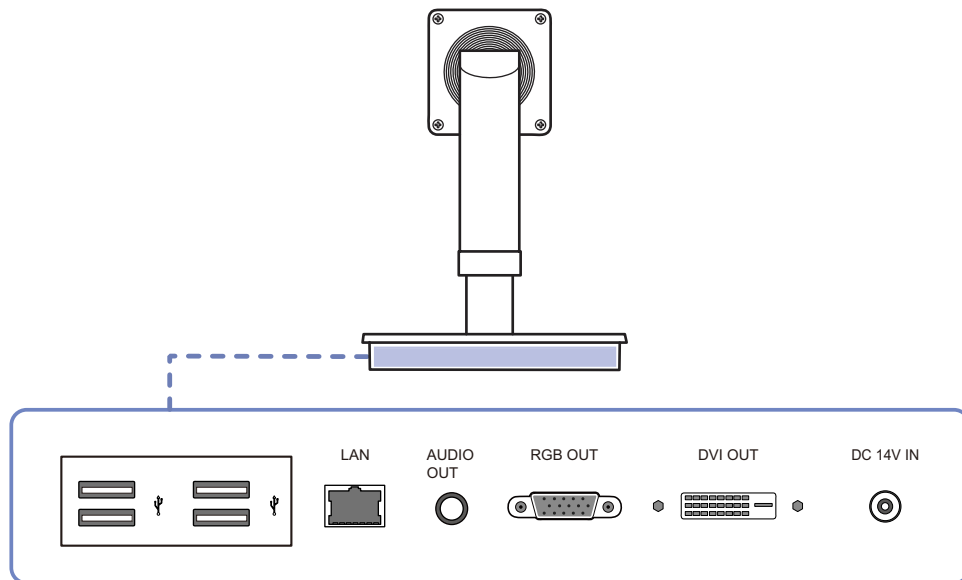

Icon	Description
	Power on or off the product.

## 1.2.2 Reverse Side



The color and shape of parts may differ from what is shown. Specifications are subject to change without notice to improve quality.

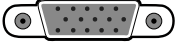

Ports	Description
	Connect to a USB device.
LAN 	Connect to a network using the LAN cable.
AUDIO OUT 	Connect to an audio output device such as headphones.
RGB OUT 	Connect to the monitor using the D-SUB cable.
DVI OUT 	Connect to the monitor using the DVI cable.
DC 14V IN 	Connect to the DC power adapter.







### 1.2.3 Right Side View

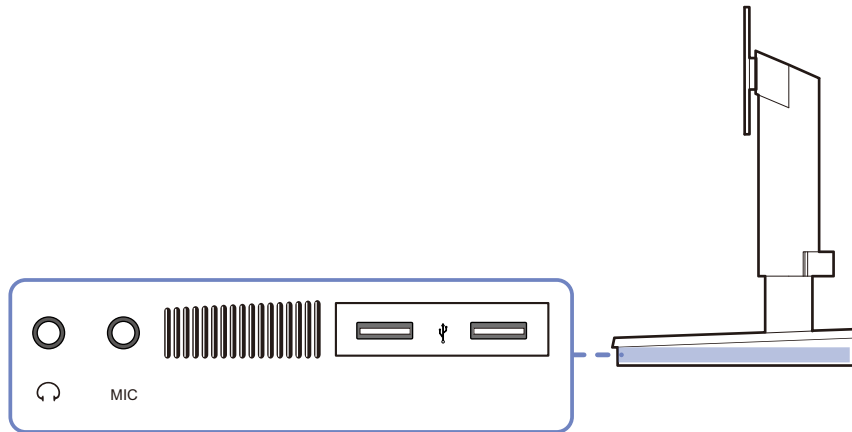

The color and shape of parts may differ from what is shown. Specifications are subject to change without notice to improve quality.



Ports	Description
 	Connect to an audio output device such as headphones.
 MIC	Connect to a microphone.
	Connect to a USB device.
	Speaker (located on both sides).

## 1.3 Installation

### 1.3.1 Reassembly

Ensure the monitor that will be connected to the stand complies with VESA standards.

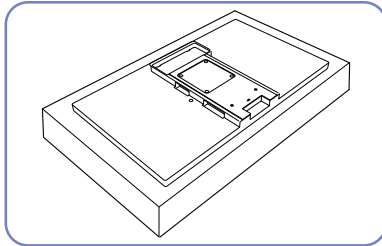

Prepare a monitor that will be connected to the stand. Put a protective cloth or cushion on a flat surface. Next, place the monitor facing down onto the cloth or cushion.

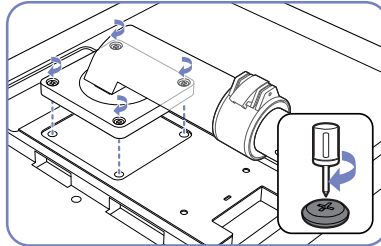

Align the grooves on the monitor to the grooves on the stand connector. Then, fasten with screws.

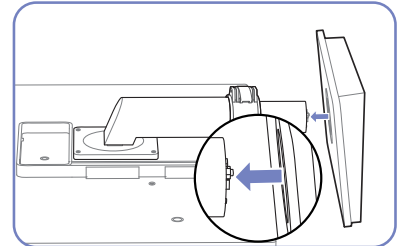

Insert the stand base into the stand in the direction of the arrow.

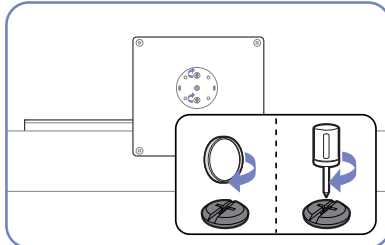

Fasten the screw tightly (using a screwdriver or coin) into the bottom of the stand base.

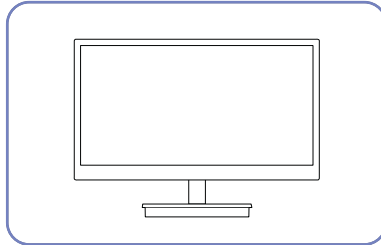

After installing the stand, place the product upright.



- The color and shape of parts may differ from what is shown. Specifications are subject to change without notice to improve quality.
- The monitor images in this manual are for reference only. Monitor is sold separately.
- Using screws longer than the supplied screws may cause internal product damage.
- Do not use a monitor or screw that does not comply with VESA standards. Also, do not use excessive force when attaching the stand to the monitor. The product may get damaged or fall and cause personal injury. Samsung shall not be held liable for any damage or injury caused by using improper screws or attaching the wall-mount kit or desktop stand using excessive force.

## Caution

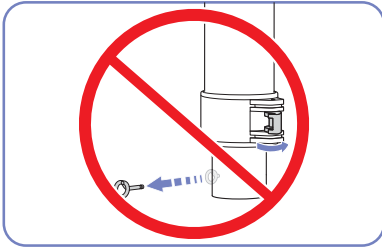

Do not unfasten the lock or remove the fixing pin on the stand before attaching the stand base to the stand.

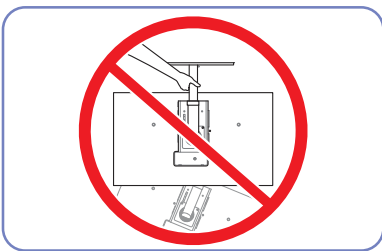

Do not hold the product upside down only by the stand.

### 1.3.2 Adjusting the Product Height

Adjust the stand height after attaching the stand to the monitor.



The color and shape of parts may differ from what is shown. Specifications are subject to change without notice to improve quality.

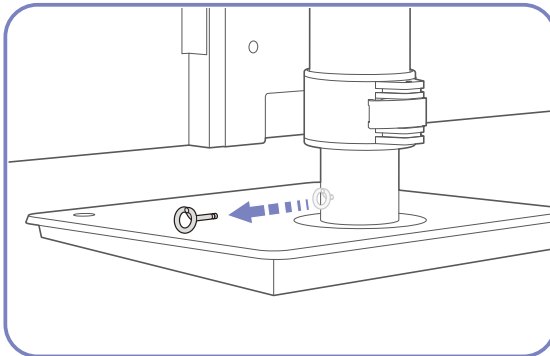

Remove the fixing pin.

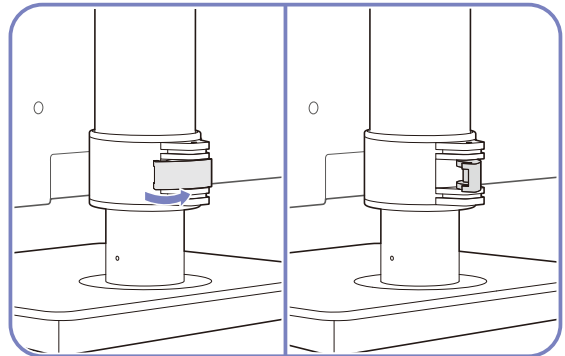

Unfasten the lock (outward direction) fixing the stand height.

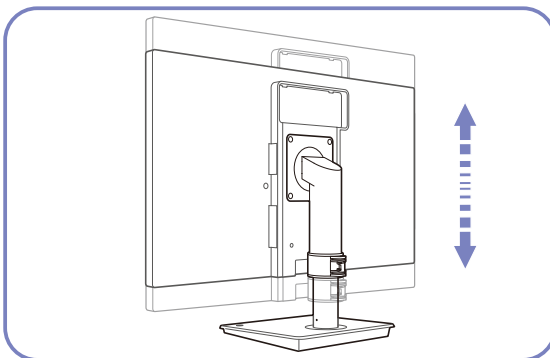

Adjust the stand height as desired.

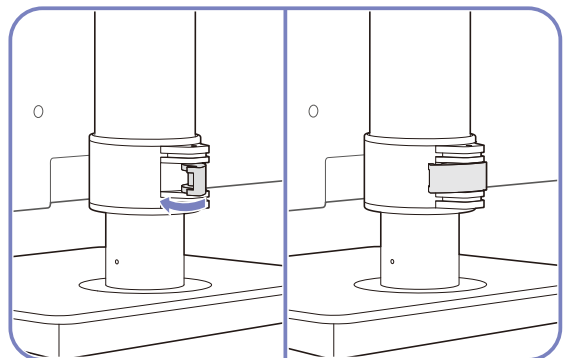

Fasten the lock (inward direction) on the stand.

- Hold the top center of the product and adjust the height carefully.

### 1.3.3 Anti-theft Lock

An anti-theft lock allows you to use the product securely even in public places. The locking device shape and locking method depend on the manufacturer. Refer to the user guide provided with your anti-theft locking device for details. The lock device is sold separately.

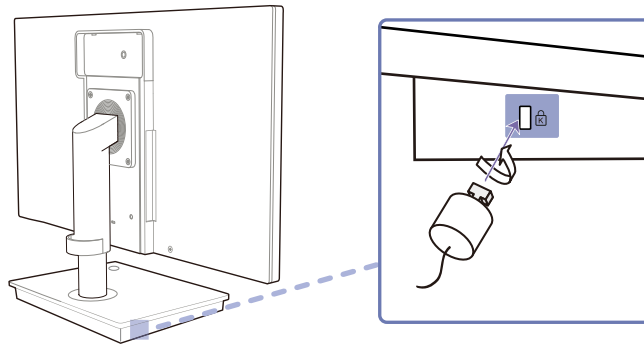

#### To lock an anti-theft locking device:

- 1 Fix the cable of your anti-theft locking device to a heavy object such as a desk.
- 2 Put one end of the cable through the loop on the other end.
- 3 Insert the locking device into the anti-theft lock slot at the back of the product.
- 4 Lock the locking device.



- An anti-theft locking device can be purchased separately.
- Refer to the user guide provided with your anti-theft locking device for details.
- Anti-theft locking devices can be purchased at electronics retailers or online.
- The monitor images in this manual are for reference only. Monitor is sold separately.

## 2.1 What is "Windows Embedded Standard 7" Client?

The **Microsoft Windows Embedded Standard 7 (WES7)** client uses the **Microsoft Windows Embedded Standard 2011 OS**. When the WES client is connected to a server where **Citrix XenDesktop**, **VMWare View Client**, or **Microsoft Remote Desktop Connection** service is available, the keyboard, mouse, audio/video, and display data will be forwarded to the client through the network between the client and server.

### Connectable Servers

- A **Citrix XenDesktop** Server
  - **Microsoft Windows 2000/2003/2008** Server where the **Terminal Service** and **Citrix XenServer** are installed
- A **VMWare View Client** Server
  - **Microsoft Windows 2000/2003/2008** Server where the **Terminal Service** and **VMWare Server** are installed
- A **Microsoft RDP (Remote Desktop Protocol)** Server
  - **Microsoft Windows 2000/2003/2008** Server where the **Terminal Services** are installed
  - **Microsoft Windows 7 Professional**



This manual describes the functions provided by the **WES** Client. However, it does not explain general functionalities of **WES**. For more general information on **Windows 7**, refer to Windows 7 Help provided by **Microsoft**.

## 2.2 Connection to Use "Windows Embedded Standard 7"

### 2.2.1 Before Connecting

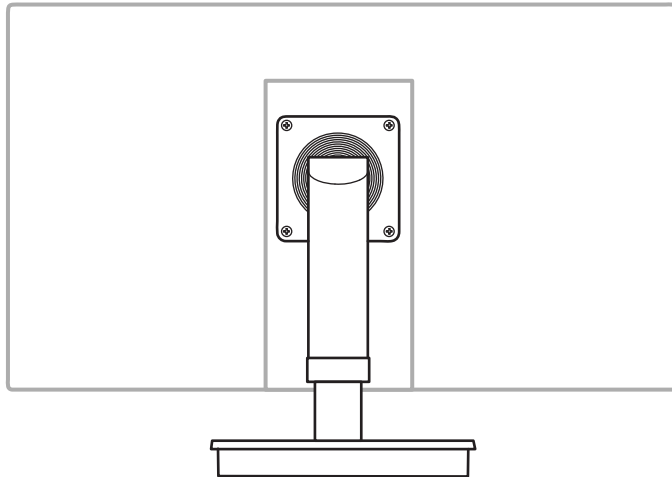

#### Pre-connection Checkpoints

- Before connecting a source device, read the user manual provided with it. The number and locations of ports on source devices may differ from device to device.
- Do not connect the power cable until all connections are completed. Connecting the power cable during connection may damage the product.
- Check the types of ports at the back of the product you want to connect.
- The port names may vary depending on the monitor.
- For details on how to change the input source for your monitor, refer to the monitor user manual.
- The monitor images in this manual are for reference only. Monitor is sold separately.

## 2.2.2 Connection Using the D-SUB Cable (Analogue Type)

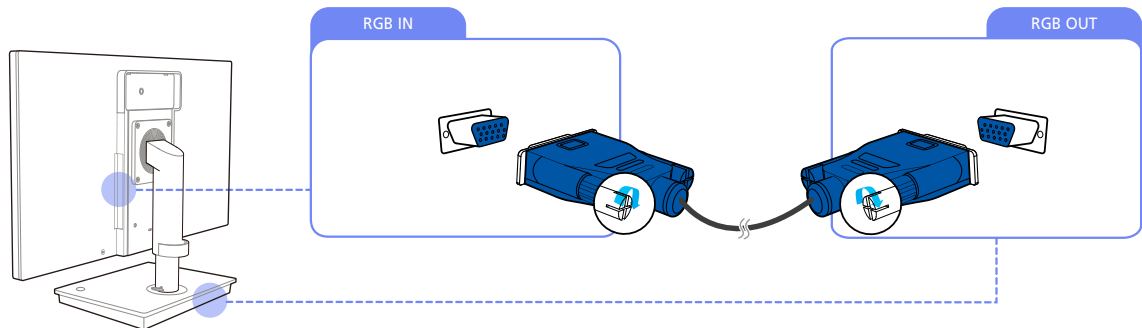

- 1 Connect the D-SUB cable to [RGB IN] on the back of the monitor and [RGB OUT] on the stand base.

## 2.2.3 Connection Using the DVI Cable

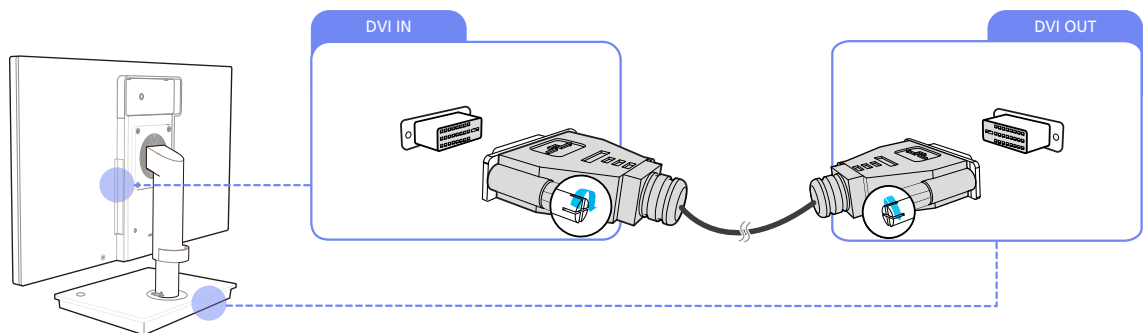

- 1 Connect the DVI cable to [DVI IN] on the back of the monitor and [DVI OUT] on the stand base.



## 2.2.4 Connecting a Microphone

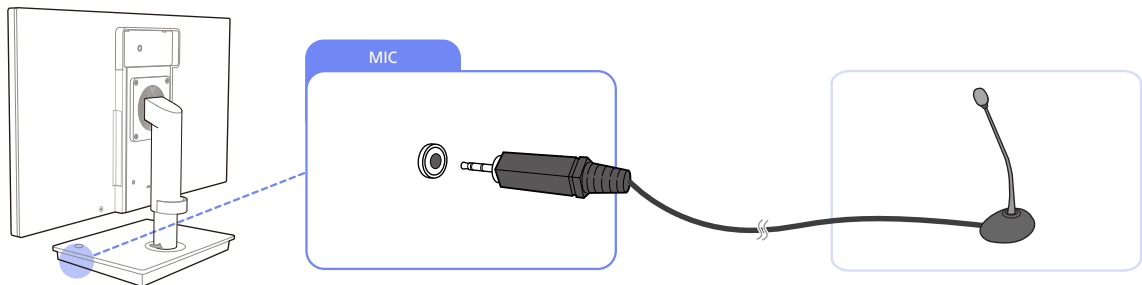

- 1 Connect the microphone to [MIC] on the right side of the stand base.

## 2.2.5 Connecting to Headphones or Speakers

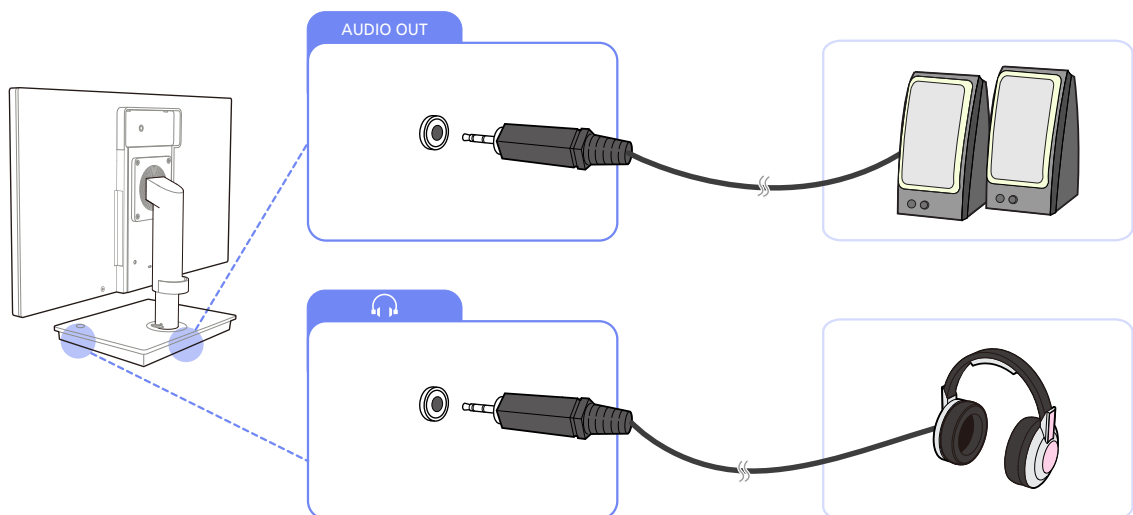

- 1 Connect an audio output device (headphones or speakers) to [AUDIO OUT] on the back or [🎧] on the right side of the stand base.

## 2.2.6 LAN Connection

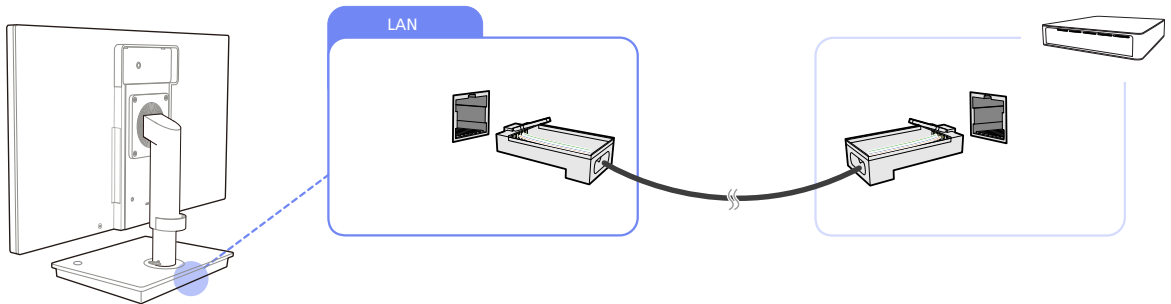

1 Connect the LAN cable to [LAN] on the back of the stand base.



- It is not supported when the network speed is below or equal to 10Mbps.
- Ensure you use the CAT 5 (\*STP type) cable.  
\*Shielded Twist Pair

## 2.2.7 Connecting USB Devices

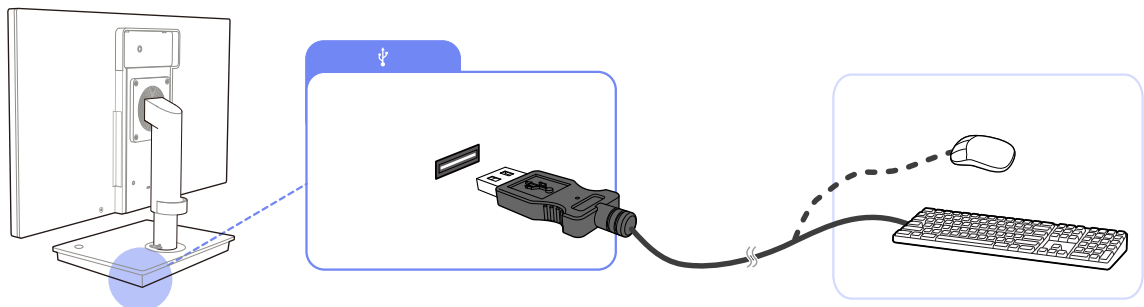

1 Connect USB devices (keyboard, mouse, etc.) to [USB] on the back or right side of the stand base.

## 2.2.8 Connecting the Power

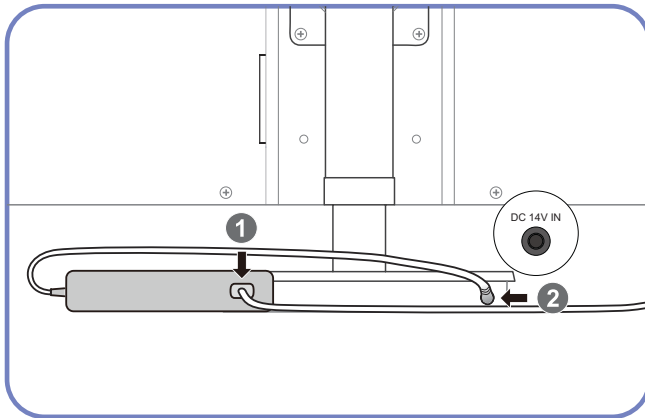

Connect the power cable to the DC power adapter. Next, connect the DC power adapter to [DC 14V IN] on the stand base.

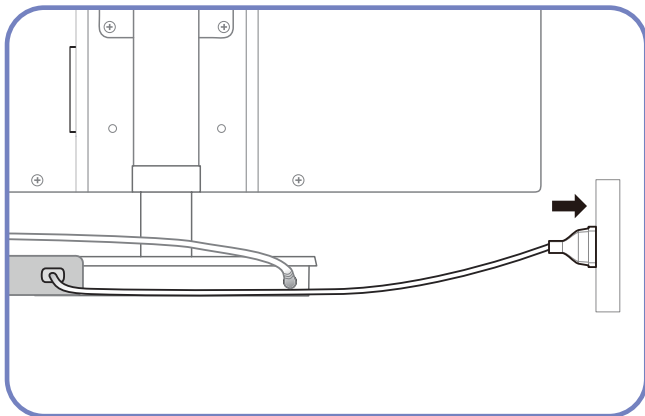

Plug in the power cable to the power socket.



- The color and shape of parts may differ from what is shown. Specifications are subject to change without notice to improve quality.
- The monitor images in this manual are for reference only. Monitor is sold separately.
- For details on how to connect the power cable to the monitor, refer to the monitor user manual.

## 2.3 Using "Windows Embedded Standard 7"

### 2.3.1 Logon

When the client starts, you can logon to the server by entering your username and password. The default account IDs are **Administrator** and **User**. The corresponding passwords are not set.

### 2.3.2 "Windows Embedded Standard 7" Desktop

#### User

When you log in, the **User** Desktop appears. The default icons that appear on the **User** Desktop are **Recycle Bin**, **Computer**, **Citrix Online Plug in**, **VMWare View Client**, **Remote Desktop Connection** and **Internet Explorer**. You can also run this connection from the **Start** menu. The audio volume icon and system time are displayed on the **User** Taskbar.

When logged on as a **user**, there are many restrictions that protect the system from incorrect user actions. You cannot access the system drives and there are restrictions on configuring properties for them. To configure the client's advanced and detailed settings, log on as an **administrator**.

#### Administrator

If you logon as **Administrator**, the **Administrator** Desktop appears. The default icons that appear on the **Administrator** Desktop are **Recycle Bin**, **Computer**, **Citrix Online Plug in**, **VMWare View Client**, **Remote Desktop Connection** and **Internet Explorer**. You can also run the **Citrix Online Plug in**, **VMWare View Client**, **Remote Desktop Connection**, and **Internet Explorer** from the **Start** menu. The audio volume icon, Enhanced Write Filter status icon, and system time are displayed on the **Administrator** Taskbar. The **Administrator** privilege is required for adding and removing programs.

#### Log off, Restart, Shut down

- To log off the current session, shut down or restart your client, use the **Start** menu. [**Start** → **Shut down**]. The **Shut Down** Windows dialog box is displayed. To shut down the client immediately, select [**Start** → **Shut down**]. To select **Log off**, **Restart**, etc., move the mouse over the ► icon next to [**Shut down**]. Alternatively, you can perform Log off or **Shut down** using the Windows Security Dialog box by pressing [**Ctrl + Alt + Del**]. If 'Force Auto Log on' is activated, you will be immediately logged on after each log off.
- The Client **Log off**, **Restart** and **Shut down** take effect on the operations of the EWF (Enhanced Write Filter). To keep the changed system configuration, you must save a cache for the current system session into flash memory. Failing to do so will cause the changed configuration to be lost when the client is shutdown or restarted. (In the case of logging off, the configuration is remembered when login in again.) For more information on the **Enhanced Write Filter**, refer to the Program Help.

### 2.3.3 Programs

#### Remote Desktop Connection

You can control a running terminal server or another computer (**Windows 95** or later) remotely through a remote desktop connection.

- **Remote Desktop**

- **Windows 7 Professional** or **Windows 2000/2003/2008 Server** must be installed on the computer to be controlled remotely. This computer is called a host.
- A remote computer running on an operating system later than **Windows 95** is required. This remote computer is called a client. The client software for the remote desktop connection must be installed on the client.
- You must also be connected to the Internet. A broadband Internet connection is good for high performance. However, because the remote desktop transmits a minimum set of data including the display data and keyboard data to control the host remotely, a broadband Internet connection is not required. You can run a remote desktop on a low bandwidth Internet connection.



When running a remote desktop on **Windows 7 Professional**, you cannot use the operating system of your computer.

- **Enabling Your Computer as the Host**

You must enable the **Remote Desktop** feature to control it from another computer. You must be logged on as an **administrator** or a member of the **Administrators group** to enable **Remote Desktop** on your computer. Follow these steps:

- 1 Open the **System** folder in the **Control Panel**.
- 2 Go to [**Start** → **Control Panel** → **System and Security** → **System**], and click **Remote settings**.
- 3 If you want to block other PCs from accessing your PC using **Remote Desktop** or **RemoteApp**, select "**Don't allow connections to this computer.**"



- To allow a remote PC to access your PC using any version of **Remote Desktop** or **RemoteApp**, select "**Allow connections from computers running any version of Remote Desktop (less secure).**" This option is suitable if you do not know the **Remote Desktop Connection** version being used on other PCs. Note that this option is less secure than the next option (option 3).

## Using "Windows Embedded Standard 7" (TB-WH)

- To allow a remote PC to access your PC using a **Remote Desktop** or **RemoteApp** version requiring a networklevel authentication, select "**All Remote Assistance connections to this computer**" to run **Remote Desktop** using network-level authentication.

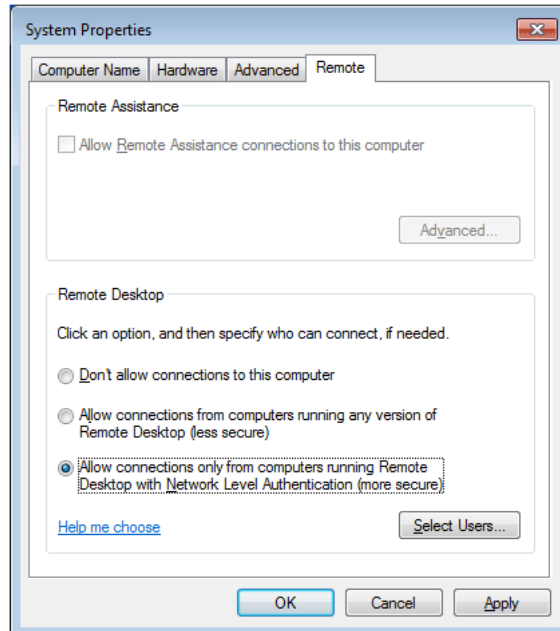

- Start a Remote Desktop Session on the Client

Once you have enabled your host computer to allow remote connections and installed the client software on a Windowsbased client computer, you are ready to start a **Remote Desktop** session. You must first establish a virtual private network connection or remote access service connection from your client computer to your host computer. To connect to another remote desktop, follow the instructions below.

- Go to [Start → All Programs → Accessories → Remote Desktop Connection] or double-click the **Remote Desktop Connection** icon to open **Remote Desktop Connection**.
- Enter the host computer name. You can configure detailed settings by clicking the **Options** button.

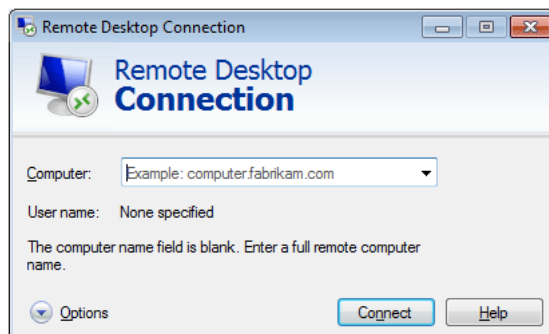

## 3 Options

- **General** : Enter in the login information for the host computer. To log in automatically, enter in the user name and password.

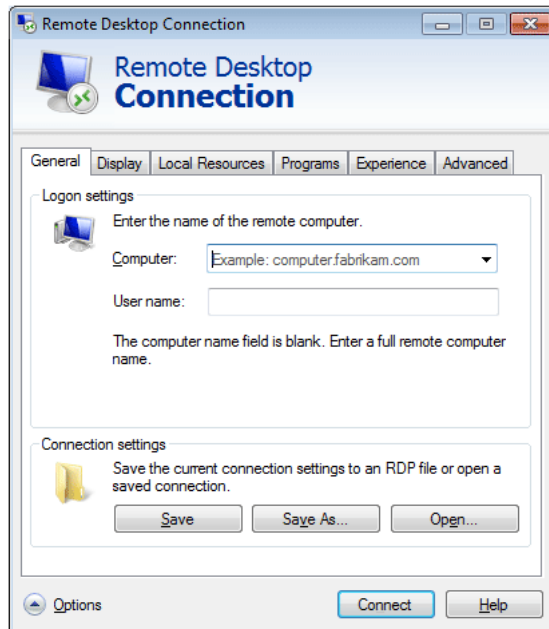

- **Display** : The **Remote Desktop Connection** sends and receives compressed screen data. If you set the resolution and color quality to the high option, the speed may become slow.

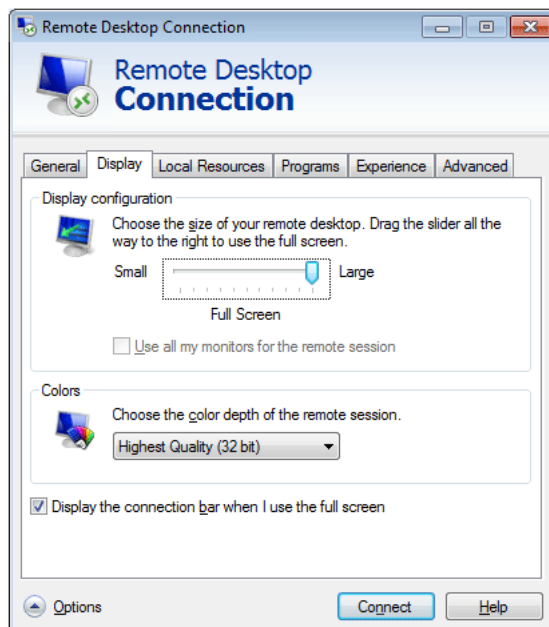

- **Local Resource** : Specify whether to use the hard disks and ports.

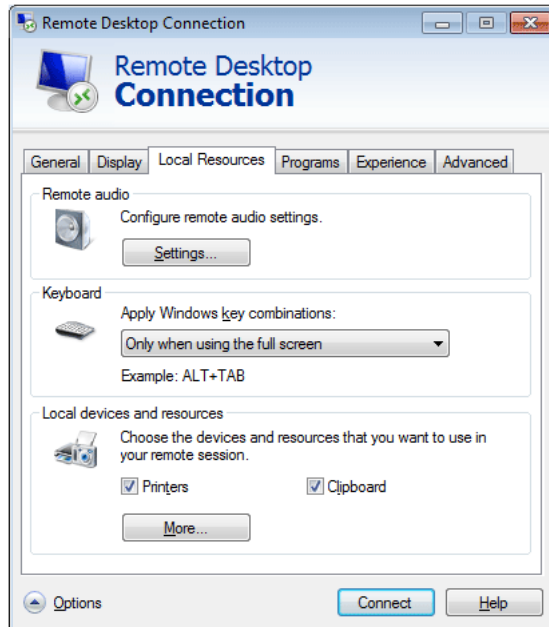

- **Programs** : Select an application and specify the folder where you want to run the application when a connection is established to the host PC.

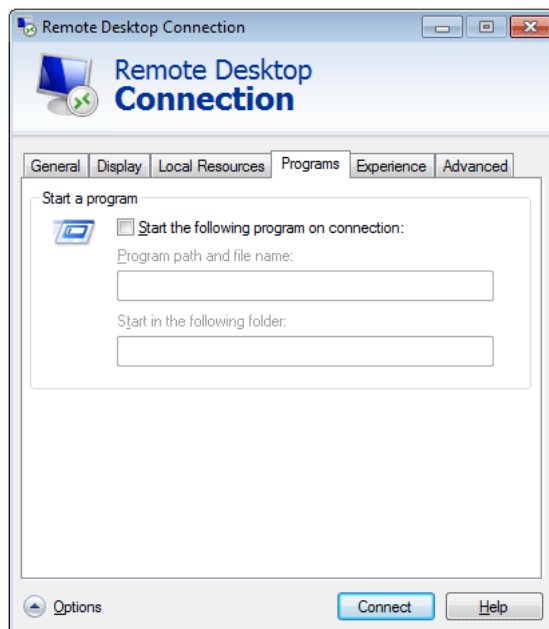



## Using "Windows Embedded Standard 7" (TB-WH)

- **Experience** : Specify the connection speed and the menu items you want to use on the remote PC connected. The settings specified will be shared with the host PC.

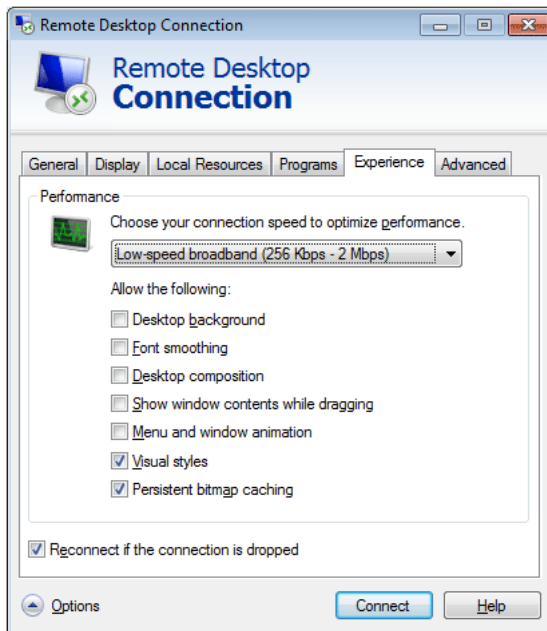

- **Advanced** : Protect your personal information when a connection is established.

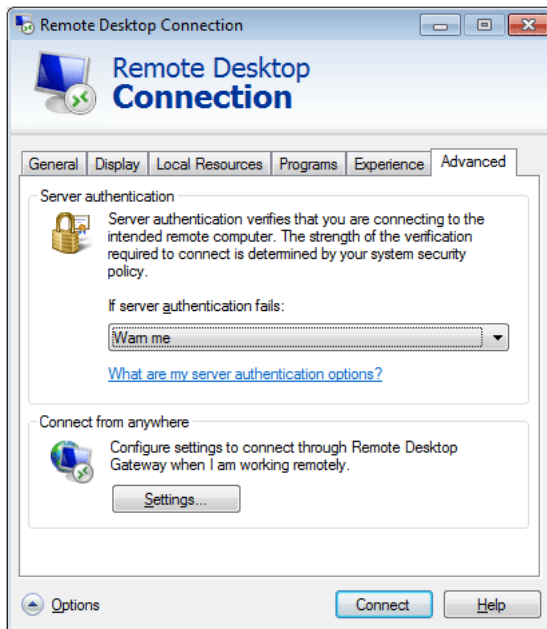

- 4 Click **Connect**. The Log On to Windows dialog box appears.
- 5 In the "Log On to Windows" dialog box, type your username, password, and domain (if required), and then click **OK**. The **Remote Desktop** window will open and you will see the desktop settings, files, and programs that are on the host computer.



For more information on **Remote Desktop Connections**, visit the **Microsoft** web site.

### Internet Explorer

A WES Client includes **Internet Explorer**. This program is permitted for all users. **Microsoft** website.



For more information on Internet Explorer, visit the Microsoft website.

### Enhanced Write Filter (EWF)

**Enhanced Write Filter (EWF)** protects a flash volume from write access and consequently, preserves the durability of the flash device. **EWF** provides read and write access through a cache to the client instead of allowing direct access to a flash volume.

If **EWF** is activated, data is not stored to the flash. The data stored in the cache is only effective while the client is operating. The cached data will be lost when restarting or shutting down your client. Therefore, to store the data written to the registry, favorites and cookie folders, etc., the content stored in the cache should be transferred to the flash. An error message is displayed when it is not possible to write to the cache due to a lack of memory. If this message is displayed, you have to deactivate **EWF** to flush the **EWF** cache. The user can double-click the **EWF** icon on the tray at the bottom right of the screen to call the **EWF** Manager. A user can also change the **EWF** configuration by entering **EWF** management commands at the command prompt. This task requires the **Administrator** privilege.

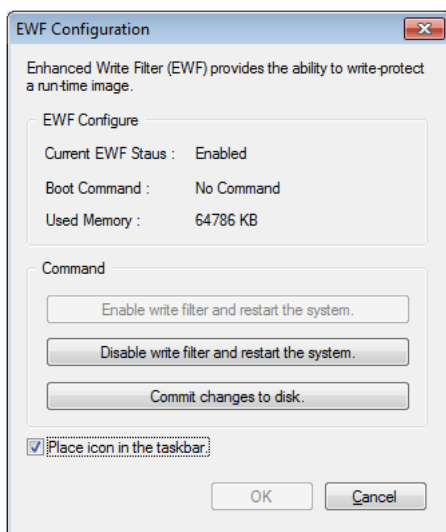

- **Enable write filter and restart the system.**

If the **EWF** is disabled, enable it. If this item is selected, the cache is flushed and the **EWF** is enabled. After restarting your computer, the configurations and file system information for the client are written to a cache. You can also perform this operation by entering "**ewfmgr.exe c: -enable**" at the command prompt and restarting your computer.

- **Disable write filter and restart the systems.**

This item is activated when the **EWF** is running. If this item is selected, the current states of the client (saved in a cache) are saved to a flash volume and the **EWF** is disabled. After restarting your computer, the configurations and file system information for the client are written to a flash volume.

You can also perform this operation by entering "**ewfmgr.exe c: -commitanddisable**" at the command prompt and restarting your computer.

- **Commit changes to disk.**

This item is activated when the **EFW** is running. If this item is selected, the current states of the client (saved in a cache) are saved to a flash volume. However, the state of **EFW** will not be changed. You can also perform this operation by entering "**ewfmgr.exe c: -commit**" at the command prompt.



You can view the configurations for the protected volumes by entering "**ewfmgr.exe c:**" at the command prompt.

## File-Based Write Filter (FBWF)

The **File-Based Write Filter (FBWF)** protects the memory of the client from being overwritten by any unauthorized user. By restricting excessive writing into the memory, the **FBWF** allows you to use the client for a long time. If you request I/O, the **FBWF** has the client perform its operations using the cache instead of the memory so that the memory can be protected.

The data saved in the cache is preserved while the client operates normally. It is removed when it is restarted or exited. To save the changes, you should write the relevant file onto the disk using the commit command. If you don't know which file is changed, disable the **FBWF**, change it, and enable it again.

You can control the **FBWF** using the various options of the command at a command prompt.

- **FBWF Configuration**

- **Current FBWF status** : Displays the current status of the **FBWF (Enabled or Disabled)**.
- **Boot command** : Displays the **FBWF** command that will be performed at the next boot-up.
- **RAM Used by FBWF** : Displays the size of the RAM the **FBWF** is using. If the current status is set to "**Disabled**", the used memory is displayed as 0 KB.
- **Threshold** : Displays the maximum size of the RAM that the **FBWF** can use.

- **FBWF Command**

- **Enable the FBWF and reboot the system** : Enables the disabled **FBWF** and restarts the client. If the client is not restarted, only the boot command is changed to BWF\_ENABLE and the current status is not changed.
- **Disable the FBWF and reboot the system** : Disables the enabled **FBWF** and restarts the client. If the client is not restarted, only the boot command is changed to FBWF\_DISABLE and the current status is not changed.
- **Commit files** : Even if the disks are protected by the **FBWF**, you can add or delete the files you want to save on them. To write the changes onto the disk, click the **[Write the changes to the disk]** button.

- **Session Status**

- **Current session** : Displays the volumes being protected by the **FBWF** and a list of the folders and files on those volumes that are excepted from protection by the **FBWF**.

- **Next session** : Select the volumes that will be protected by the **FBWF** when the client is booted up next time. Also, select the folders and files that you want to except from protection by the **FBWF**.

## Windows Media Player

The **WES** Client includes **Windows Media Player 12**. With **Windows Media Player**, you can play audio and video files on a website.

### 2.3.4 Configuring Utilities

#### Local Drive

- C Drive

The C drive is used for the system. The client OS will not operate if space available on the system drive is not sufficient. Ensure sufficient space is available on the C drive. **EFW** can help maintain available space by preventing the C drive being written to directly.

- **Saving Files**

Your client uses a fixed size of flash memory. Therefore, it is better to save files to the server rather than to your client.

#### Mapping a Network Drive

The **Administrator** can map a folder to a network drive. To keep the mapping information after restarting the client, take note of these directions carefully.

- Select the **Reconnect** at logon checkbox in the **Map Network Drive** dialog box.
- If the **EFW** or **FBWF** is enabled, you must disable it before proceeding with installation.

## 2.3.5 Recover the System

### Overview

The WES Client provides a recovery function which allows you to revert to a backed up system when encountering a serious problem. You can back up an OS image which is working normally to USB memory or the PXE server. You can revert to a backed up image when your client has one of these problems:

- When a system file is deleted accidentally or is corrupted
- When the client computer is unstable or there is a problem with a device driver
- When problems occur, after installing a new program or device
- When the client computer is infected with a virus
- When Windows Embedded Standard fails to start

### How to Recover the System

- Recovery Using USB Memory

By following these steps, you can save all necessary files to USB memory, and boot up with the backed up system on the USB memory and recover the system.

- 1 Perform system formatting for your USB memory in order to make it bootable.
- 2 Save the **Windows Embedded Standard** image and the Backup/Recovery Utility which will be recovered later to your USB memory.
- 3 Boot up with the USB memory.
- 4 Recover the system using the **Windows Embedded Standard** image and the Backup/Recovery Utility in the USB memory.

- Recovery Using Network Booting

This method is provided through the **PXE (Preboot eXecution Environment)** server. The PXE sever provides a client/server interface based on **TCP/IP**, **DHCP**, and **TFTP**. It allows an administrator at a remote location to configure and boot the operating system onto a client over a network.

- Implement a PXE server.
- Save the **Windows Embedded Standard** image and the Backup/Recovery Utility which will be recovered later onto the PXE server.
- Boot the client via the network.
- Recover the system using the Windows Embedded Standard image and the Backup/Recovery Utility saved on the PXE server via the network.



For more information, refer to the PXE Server User Manual.

## 2.4 MagicRMS Pro

### 2.4.1 About MagicRMS Pro

The **MagicRMS Pro** program can be used to remotely control a Samsung network monitor. The design of the user-oriented interface makes it easy and convenient to use.

Using **MagicRMS Pro**, you can schedule a task to be performed at a specified time on a network monitor.

Also, you can manage multiple network monitors efficiently by grouping or filtering them according to specific conditions.

To use the **MagicRMS Pro Solution** or **MagicRMS Pro Agent** and to view the user guide, visit [www.samsunglfd.com](http://www.samsunglfd.com). Go to **Support>Download Center**, and search for **MagicRMS** to download.

Open source license notice

In the case of using open source software, Open Source licenses are available on the **MagicRMS Pro Agent**.

Open Source License Notice is written only English.

### 3.1 About "Zero Client"

The "Zero Client" uses a Linux operating system. When the Client connects to a server where the Citrix XenDesktop/XenApp service is available, information relating to the keyboard, mouse, audio/video and display data is transmitted from the Client to the server over the network.

#### Compatible servers

- Citrix XenDesktop/XenApp server
  - Microsoft Windows 2000/2003/2008 server where the Terminal Service and Citrix XenServer are installed

## 3.2 Connection to Use the "Zero Client"

### 3.2.1 Before Connecting

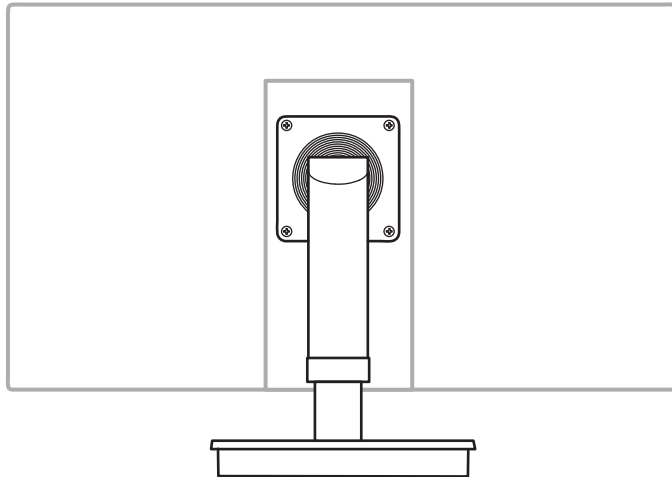

#### Pre-connection Checkpoints

- Before connecting a source device, read the user manual provided with it. The number and locations of ports on source devices may differ from device to device.
- Do not connect the power cable until all connections are completed. Connecting the power cable during connection may damage the product.
- Check the types of ports at the back of the product you want to connect.
- The port names may vary depending on the monitor.
- For details on how to change the input source for your monitor, refer to the monitor user manual.
- The monitor images in this manual are for reference only. Monitor is sold separately.



### 3.2.2 Connection Using the D-SUB Cable (Analogue Type)

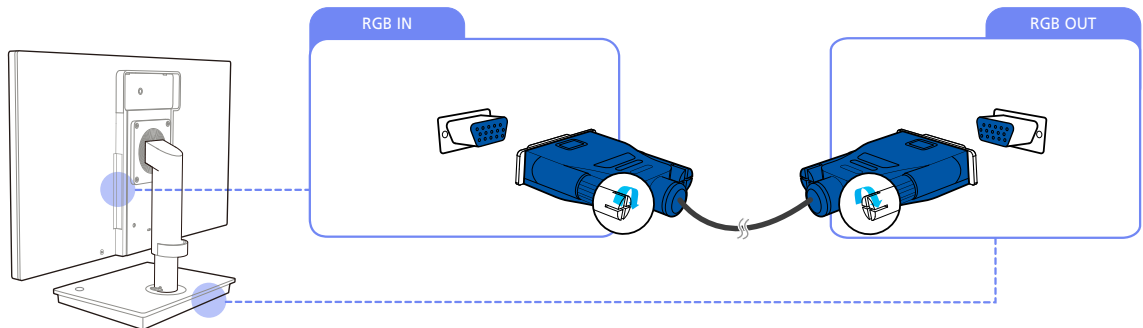

- 1 Connect the D-SUB cable to [RGB IN] on the back of the monitor and [RGB OUT] on the stand base.

### 3.2.3 Connection Using the DVI Cable

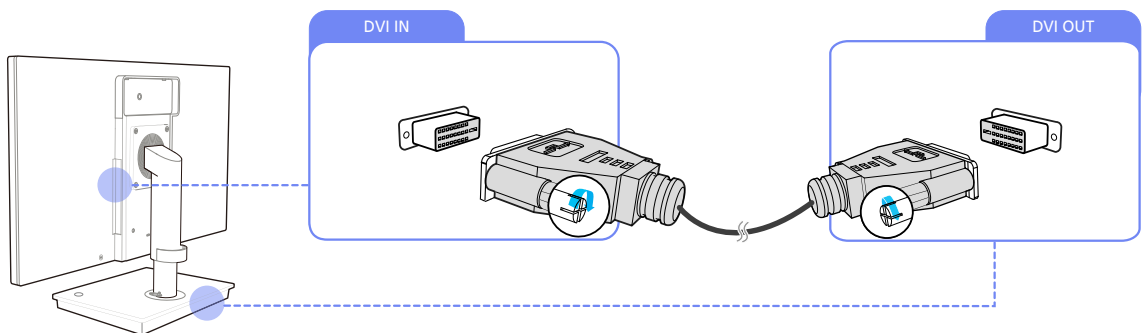

- 1 Connect the DVI cable to [DVI IN] on the back of the monitor and [DVI OUT] on the stand base.

### 3.2.4 Connecting a Microphone

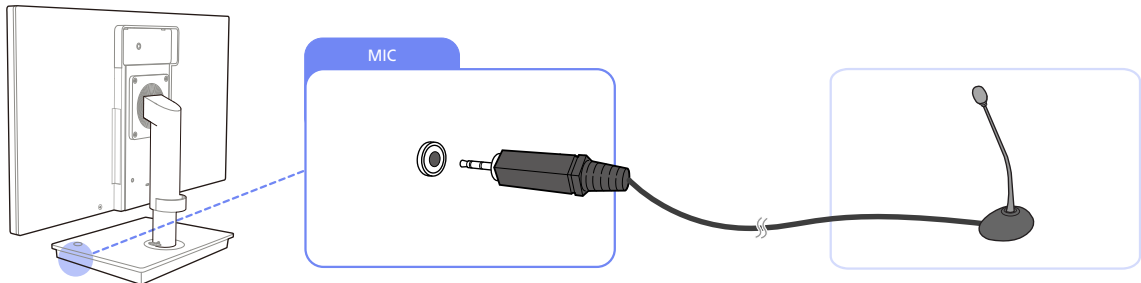

- 1 Connect the microphone to [MIC] on the right side of the stand base.

### 3.2.5 Connecting to Headphones or Speakers

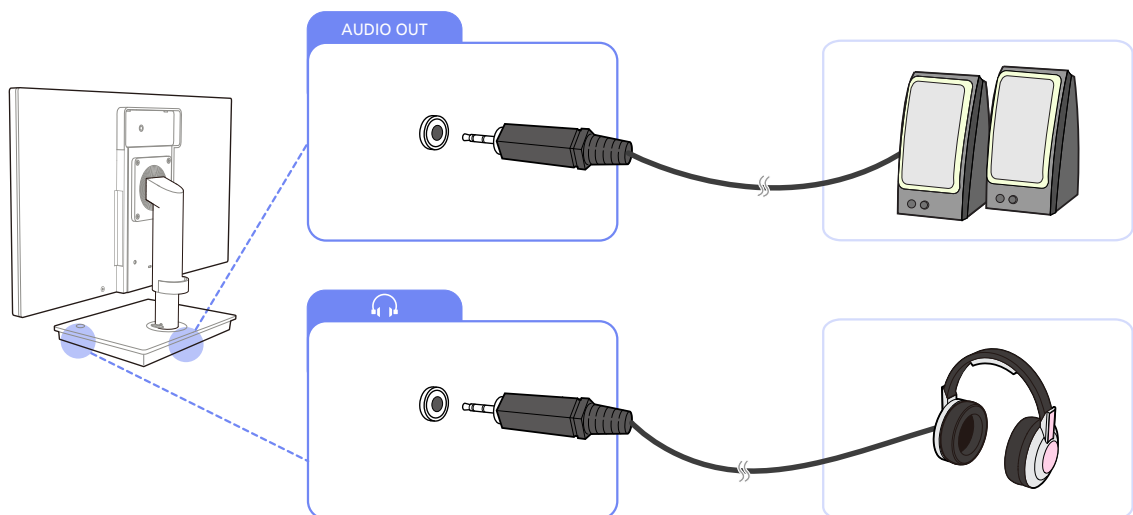

- 1 Connect an audio output device (headphones or speakers) to [AUDIO OUT] on the back or [🎧] on the right side of the stand base.

## 3.2.6 Connecting to a Server (LAN/USB Connection)

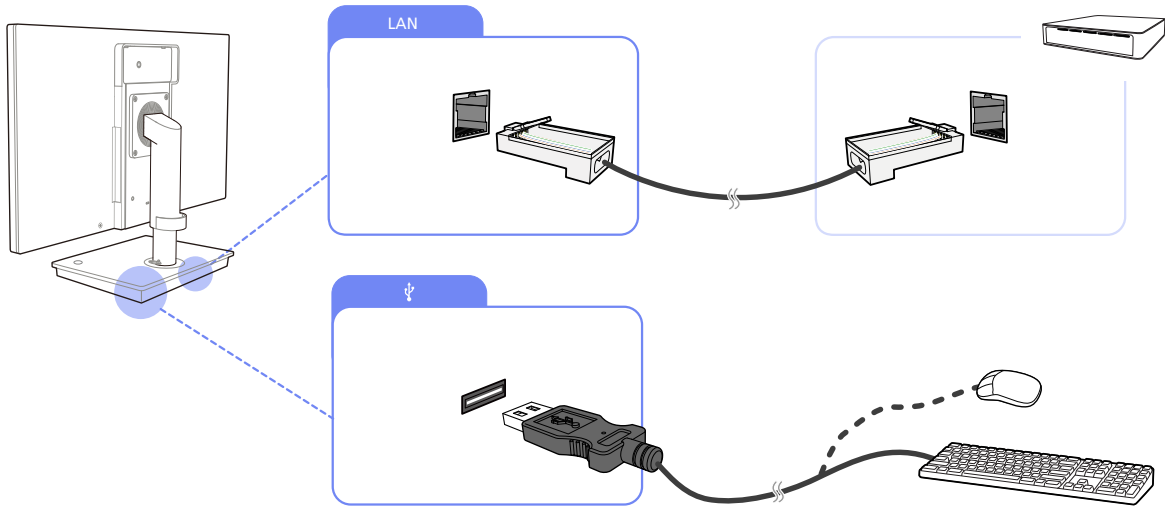

1 Connect the [LAN] port on the back of the stand base to the server using the LAN cable.



- It is not supported when the network speed is below or equal to 10Mbps.
- Ensure you use the CAT 5 (\*STP type) cable.  
\*Shielded Twist Pair

2 Connect USB devices (keyboard, mouse, etc.) to [USB] on the back or right side of the stand base.

(To use the [USB] port, ensure the Client is connected to the server.)

### 3.2.7 Connecting the Power

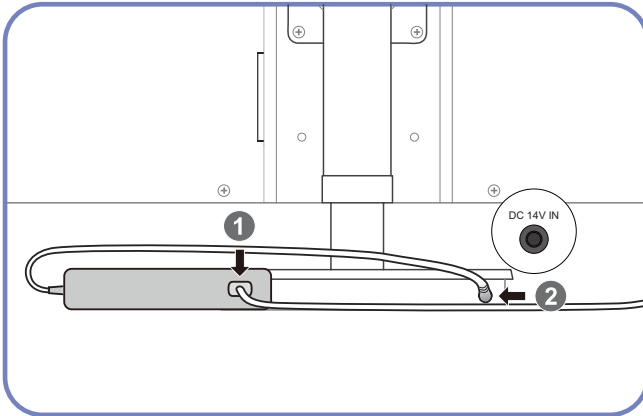

Connect the power cable to the DC power adapter. Next, connect the DC power adapter to [DC 14V IN] on the stand base.

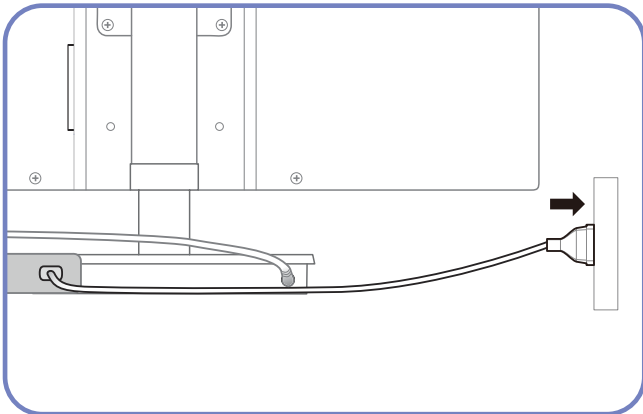

Plug in the power cable to the power socket.



- The color and shape of parts may differ from what is shown. Specifications are subject to change without notice to improve quality.
- The monitor images in this manual are for reference only. Monitor is sold separately.
- For details on how to connect the power cable to the monitor, refer to the monitor user manual.

## 3.3 Using the "Zero Client"

### 3.3.1 Login

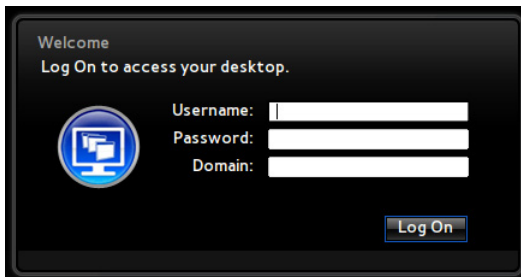

- **Username** : Enter the user name that will be used to connect to the "Citrix" server.
- **Password** : Enter the password that will be used to connect to the "Citrix" server.
- **Domain** : Enter the domain that will be used to connect to the "Citrix" server.



Ensure **Broker Server** is enabled under **Network**.

### 3.3.2 Message Box

#### MagicRMS

When the **MagicRMS** server is on, messages received from the server are displayed on the screen.

#### Message

The **Identity** function of **MagicRMS** allows you to check the host name of the Client.



### Identity

The **Identity** function of **MagicRMS** allows you to check the host name of the Client.

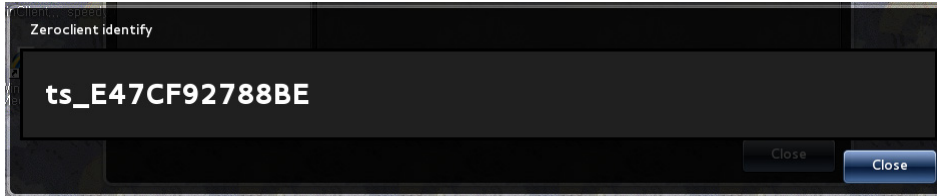

### Disconnect Message

If the Client is disconnected from the network, a message will appear indicating the disconnection. In this case, if you are logged on, the desktops/applications connected will disconnect and log off.

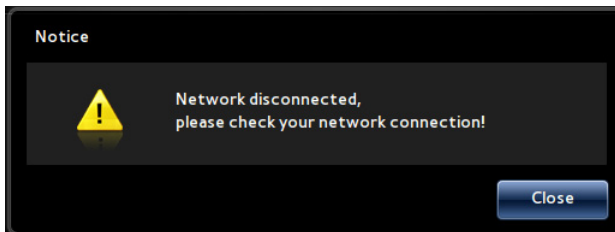

### 3.3.3 Toolbar

#### Network

You can view or configure the network and server settings for the Client.



### Local Network

You can configure the IP to connect the Client to a network.

- **Link Speed & Duplex** : Select a network connection type and speed.

Link Speed & Duplex:

- To use a static IP, deselect **Enable DHCP** and specify the IP.

IP Address:

Subnet Mask:

Default Gateway:

Enable DHCP

- To use DHCP, select **Enable DHCP**.

IP Address:

Subnet Mask:

Default Gateway:

Enable DHCP

### Name Servers

Configure the **DNS Domain** and **DNS Server** information on the Client.

- Specify the **DNS Domain**.

DNS Domain:

- Specify the **DNS Servers**. More than one **DNS Server** can be entered using “,”. e.g.)  
192.168.0.1,192.168.1.1

DNS Servers:

For example: 1.1.1.1,2.2.2.2

### DHCP Options

DHCP Option IDs			
File Server:	<input type="text" value="161"/>	Citix Server:	<input type="text" value="165"/>
Root Path:	<input type="text" value="162"/>	Domain List:	<input type="text" value="166"/>
Ftp Username:	<input type="text" value="163"/>	RMS Server:	<input type="text" value="167"/>
Ftp Password:	<input type="text" value="164"/>	RMS Port:	<input type="text" value="168"/>

To automatically configure several settings for the Client all at once using DHCP upon boot up, configure the **DHCP Options IDs**.

- Ensure the setting is specified between 128 and 254.
- If this option is configured, the setting specified will replace the customized setting.



#### Requirements

- **Local Network** must be set to **Enable DHCP**.
- Information about the Options IDs must be configured on the DHCP server.

#### Security

Client provides a security function using IEEE802.1x authentication.

#### Available modes

- EAP-PEAP (MSCHAPv2, PEAP version Automatic)
- EAP-TLS

To use this function, select **Enable IEEE802.1x Authentication** and specify the **Authentication** mode.

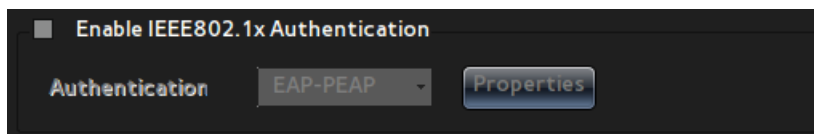

#### 1 EAP-PEAP

To use **EAP-PEAP** mode, set the **Authentication** mode to **EAP-PEAP**.

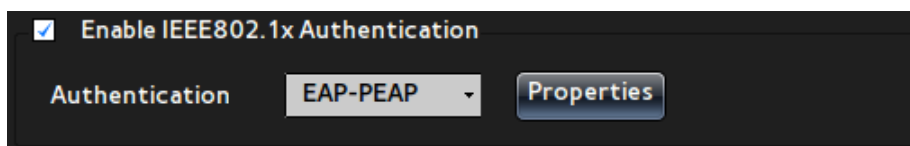

Click **Properties**, and enter the **Username** and **Password** for authentication.





## 2 EAP-TLS

To use **EAP-TLS** mode, set the **Authentication** mode to **EAP-TLS**.

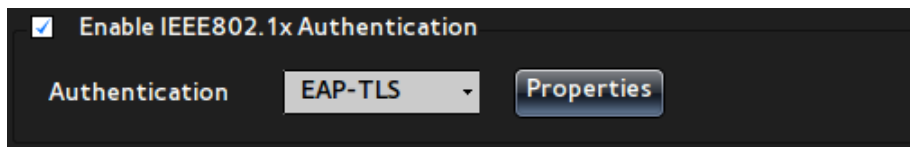

Click **Properties**, and configure the following settings for authentication. To select a certificate, ensure you copy the authentication file to the Client using **Certification Management**.

- Enter the **Identity** information.
- Select a **CA certificate** file (\*.der, \*.pem, \*.crt, \*.cer).
- Select a **Private key** file.
- Enter the **Private key password**.

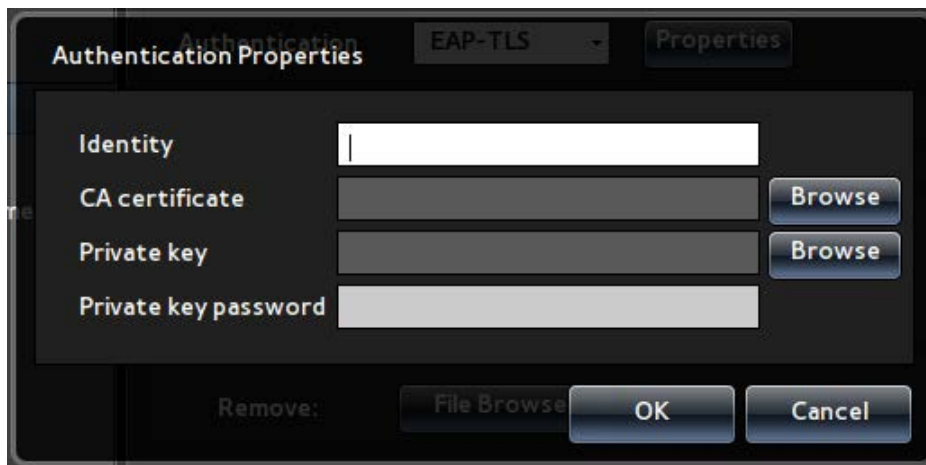

## 3 Certification Management

For you to manage authentication files that are used in **EPA-TLS** mode, the following menu options are provided.

- An option for copying a file using several methods including **USB Storage** (The file will be copied to a specific directory on the Client. )
- An option for deleting a saved file

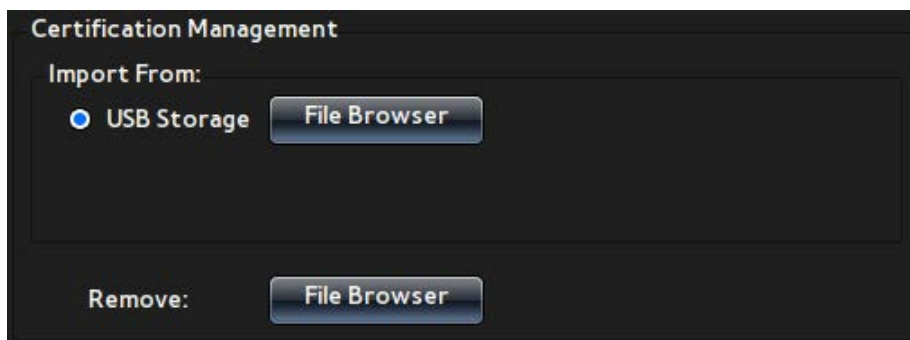

### Broker Server

Enter information to connect to the Citrix server.

# 3

## Using the "Zero Client" (TB-CH)

- Enter the IP address of the Citrix server.

XenDesktop Broker Server: 10.88.44.50

- Specify the **Default Username** and **Default Domain** that will be used to connect to the server.

Default Username: xendt05

Default Domain: xendt

### Remote Management

You can configure the settings for servers that manage the Client, enter information about the servers, or view the status of the servers.

For details on the **MagicRMS** function, refer to the **MagicRMS** user manual.

#### 1 File Server

Address:	ftp://	<input type="text"/>
Path:	<input type="text"/>	
Username:	<input type="text"/>	
Password:	<input type="text"/>	

Configure the FTP server to connect to in order to upgrade the firmware on the Client. The information configured will be used to upgrade the firmware when the Client boots up.

- **Address** : Enter the IP address of the FTP server.
- **Path** : Enter the **Path** of the FTP server where the new firmware is saved.
- **Username** : Enter the **Username** that will be used to connect to the FTP server.
- **Password** : Enter the **Password** that will be used to connect to the FTP server.



#### Requirements

- Ensure the FTP server is working properly.
- The new firmware must be in a compatible file format.

#### 2 MagicRMS Connection

<b>Connection</b>	
<input checked="" type="radio"/> Multicast	
<input type="radio"/> Server Assignment	
Address:	<input type="text" value="239.5.6.7"/>
Port:	<input type="text" value="5015"/>

Enter the **Connection** information to connect to the **MagicRMS** server.

- **Multicast**

Enable this option if you want to automatically connect to the **MagicRMS** server. Specify the **IP Address** and **Port** number for **Multicast**. If the **MagicRMS** server is assigned with the same IP address and port number as the Client, it will automatically connect to the Client.

- **Server Assignment**

If you know the static IP address and port number of the **MagicRMS** server, you can manually enter them to connect to the server.

### 3 **MagicRMS Contact**

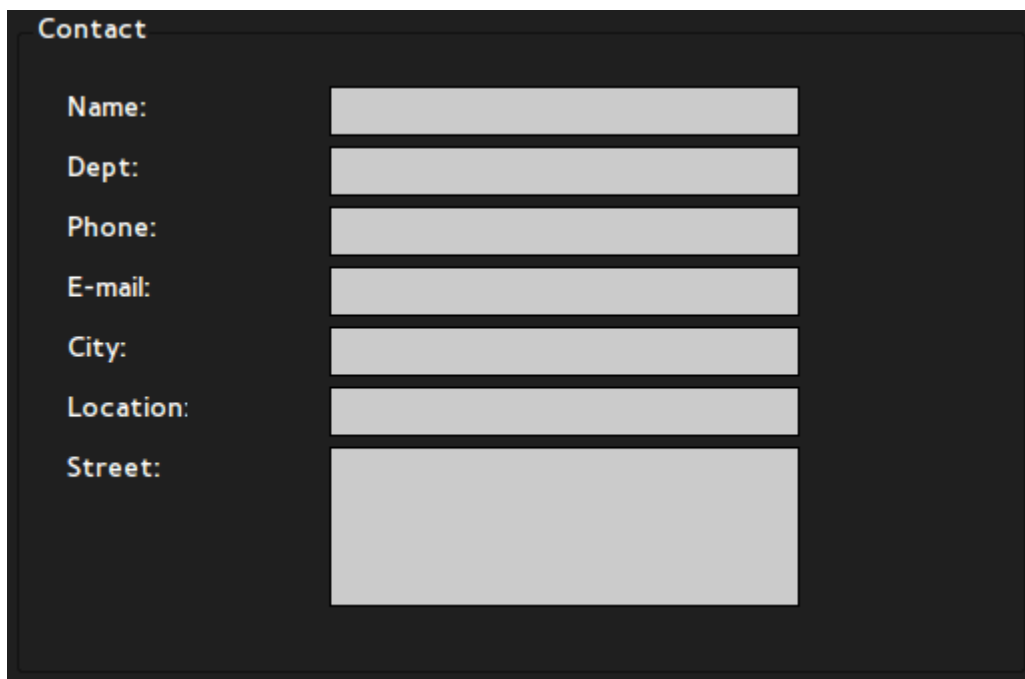

The screenshot shows a dark-themed form titled "Contact". It contains seven input fields, each with a label to its left: "Name:", "Dept:", "Phone:", "E-mail:", "City:", "Location:", and "Street:". The "Street:" field is significantly larger than the others, indicating it is for a multi-line address. All input fields are currently empty and have a light gray background.

Enter information to identify the Client on the **MagicRMS** console.

## 4 MagicRMS Status

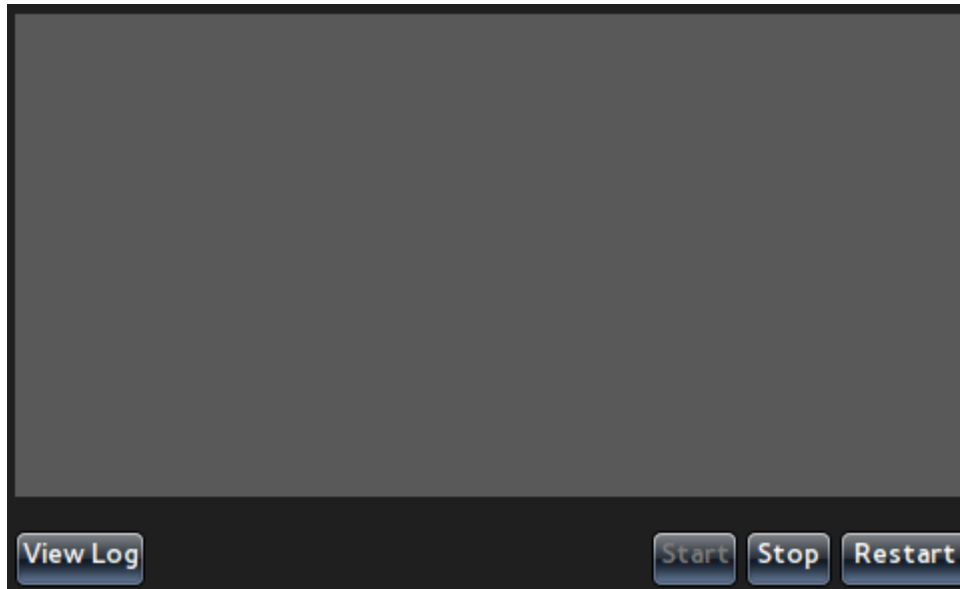

You can check the connection status of the **MagicRMS** server. If there are connection issues, check the server connection and select **Start**, **Stop**, or **Restart** to start the server.

To view details of the **MagicRMS** server logs, click **View Log**.

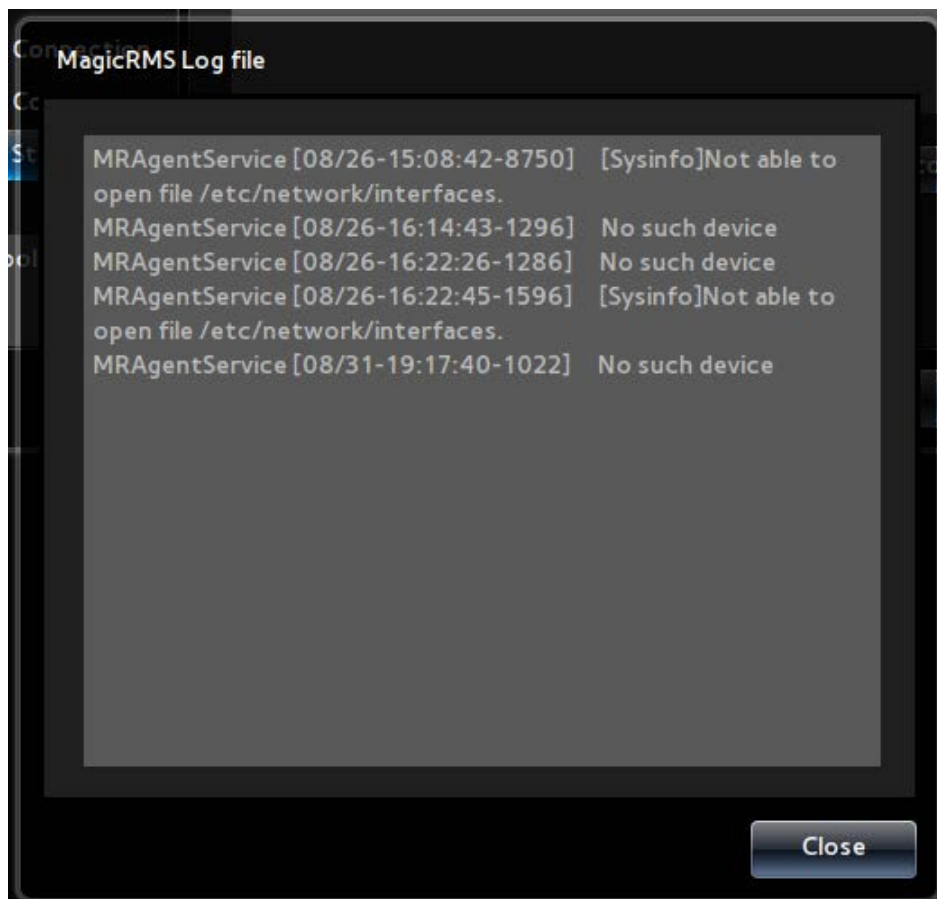

## 5 Network Tools

**Network Tools** can be used to check the connection status between the Client and network.

- **Ping**

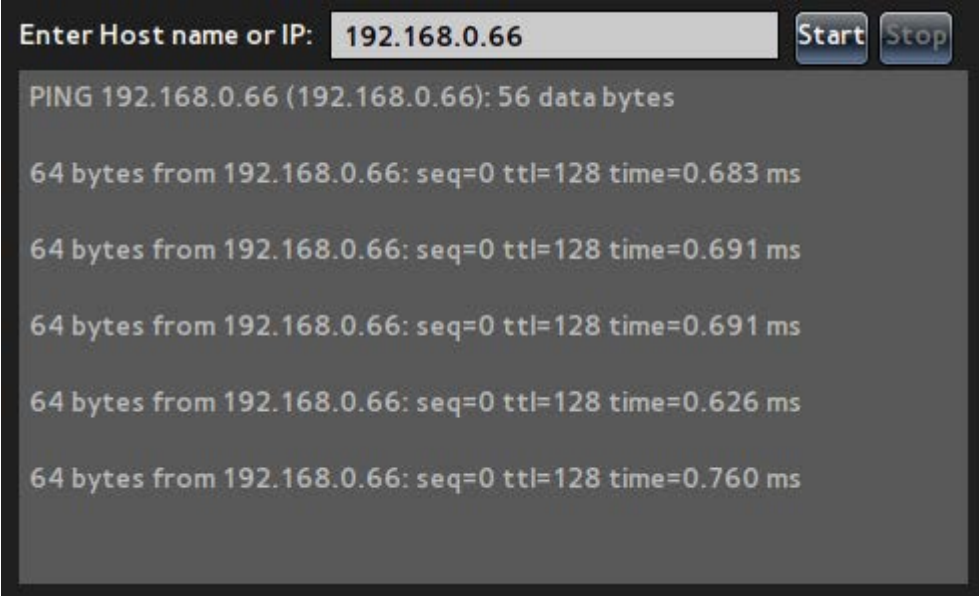

```
Enter Host name or IP: 192.168.0.66 Start Stop
PING 192.168.0.66 (192.168.0.66): 56 data bytes

64 bytes from 192.168.0.66: seq=0 ttl=128 time=0.683 ms

64 bytes from 192.168.0.66: seq=0 ttl=128 time=0.691 ms

64 bytes from 192.168.0.66: seq=0 ttl=128 time=0.691 ms

64 bytes from 192.168.0.66: seq=0 ttl=128 time=0.626 ms

64 bytes from 192.168.0.66: seq=0 ttl=128 time=0.760 ms
```

Using the Ping command, you can check the status of the network connection for the IPs entered.

- **Trace Route**



```
Enter Host name or IP: samsung.com Start Stop
traceroute to samsung.com (211.45.27.198), 30 hops max, 38 byte
packets

1 192.168.0.1 (192.168.0.1) 0.926 ms 0.659 ms 0.623 ms
```

Using the Route command, you can check the network connection status for the IPs entered.

## Terminal Properties

Configure the properties of the Client.

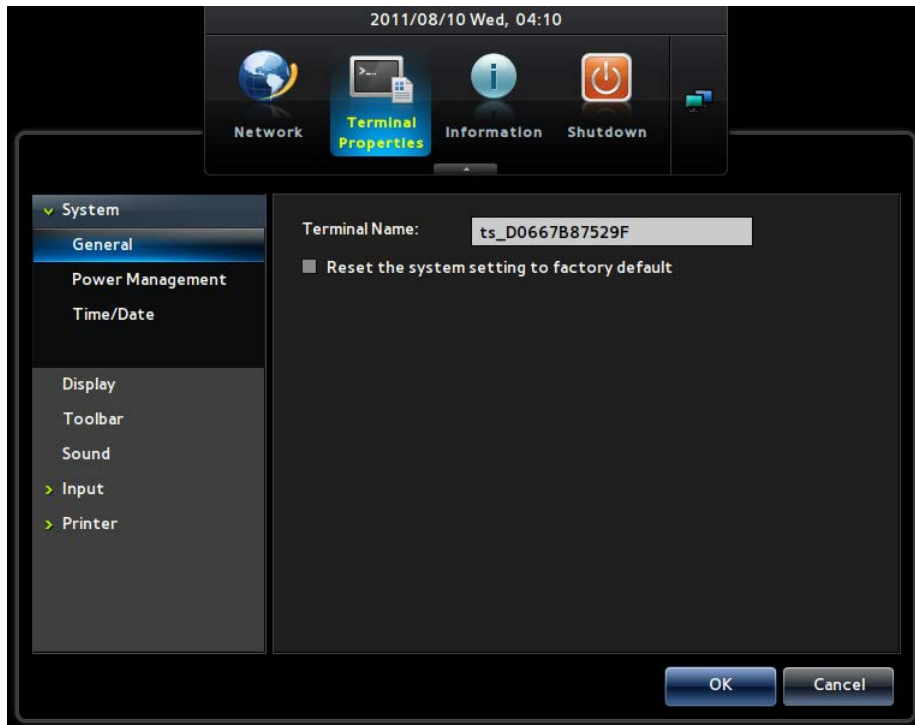

### System

#### 1 General

- **Terminal Name** : Change the Client name. The default name is "TS\_ + MAC information."

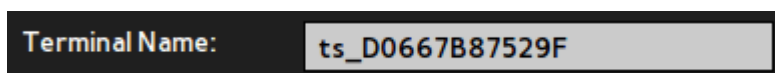

- **Reset the system setting to factory default** : Reset the Client settings by selecting the checkbox.

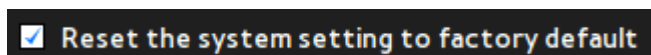

Select **Yes** in the **Notice** window that appears after selecting the checkbox. The settings will be reset.

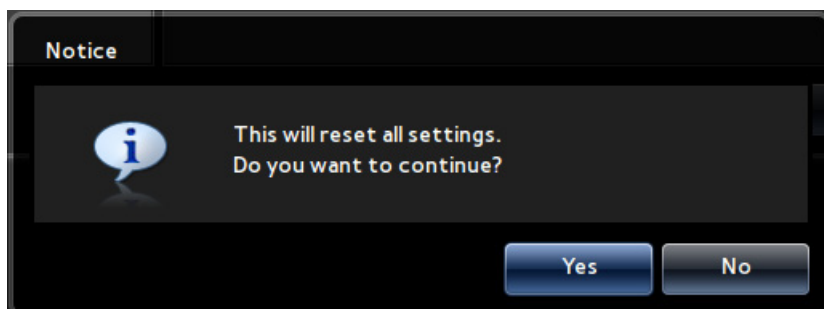

## 2 Power Management

- Control the power supply to the Client by changing the **Screen Off** setting. The Client will activate **Power Management** if it is left idle for a specified amount of time.



The following time settings are available to choose from.

- Never**
- 5 minutes**
- 10 minutes**
- 30 minutes**
- 1 hour**
- 2 hours**

## 3 Time/Date

Set the clock on the Client.

- Time Zone**

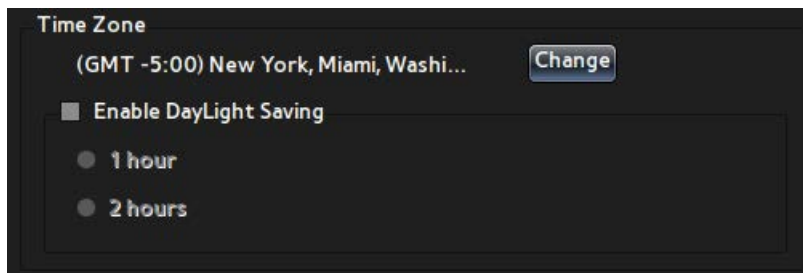

Enter the **Time Zone** information to apply to the Client. Click **Change**, and select the time zone desired.

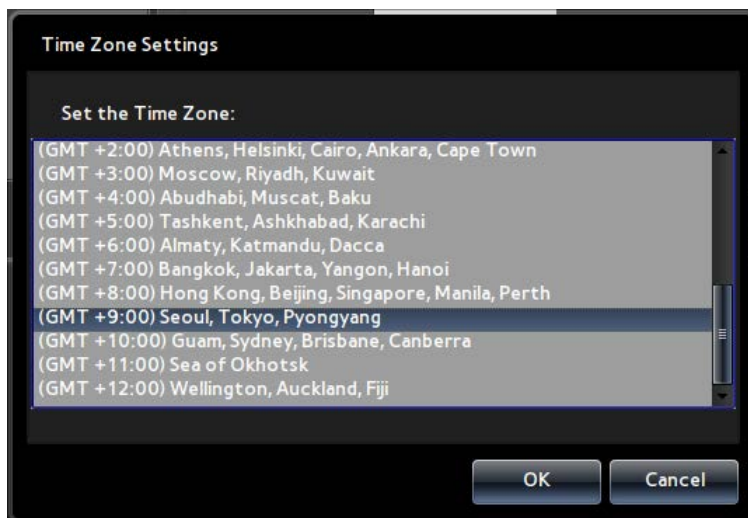

To enable DayLight Saving, select the **Enable DayLight Saving** checkbox and select the number of hours to apply.

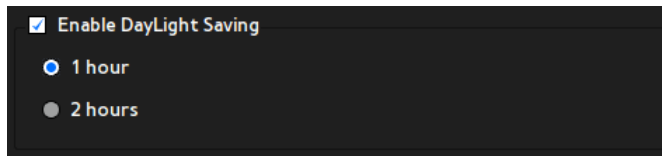

- **Time/Date Format**

- **Time Format / Date Format** : Specify the format to display the time and date on the toolbar.
- **Time Servers** : Enter the **Time Server** information provided online. The time and date on the Client will automatically be set.

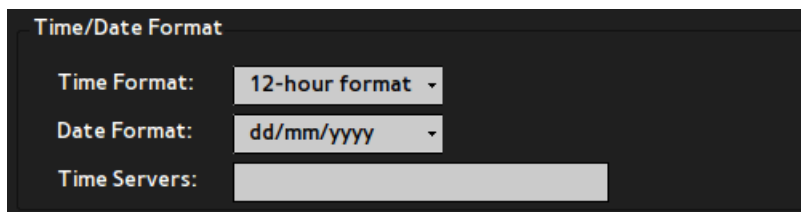

## Display

Configure the settings for display devices connected to the Client.

### 1 Orientation



Configure the screen orientation of the selected display device.

You can select **Horizontal** or **Vertical**.

### 2 Resolution



Set the resolution of the selected display device.

The resolutions available vary depending on the display device.

### 3 Multiple Display

When two display devices are connected to the Client, specify how you will use the screens.



- To display the same desktop on the displays, select **Clone**. When **Clone** is selected, the same **Orientation** and **Resolution** will be applied to the displays.

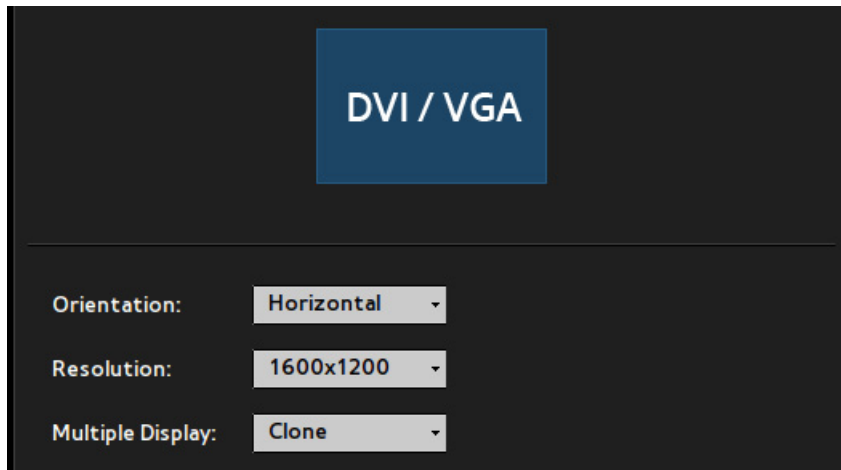

# 3

## Using the "Zero Client" (TB-CH)

- To display an extended desktop on the two displays, select **Extend**.

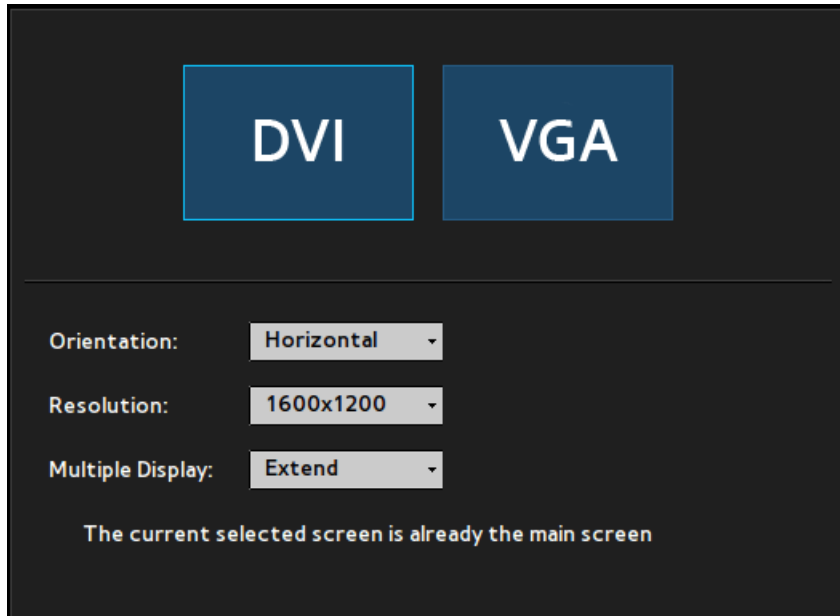

The display selected as the primary screen will be placed on the left.

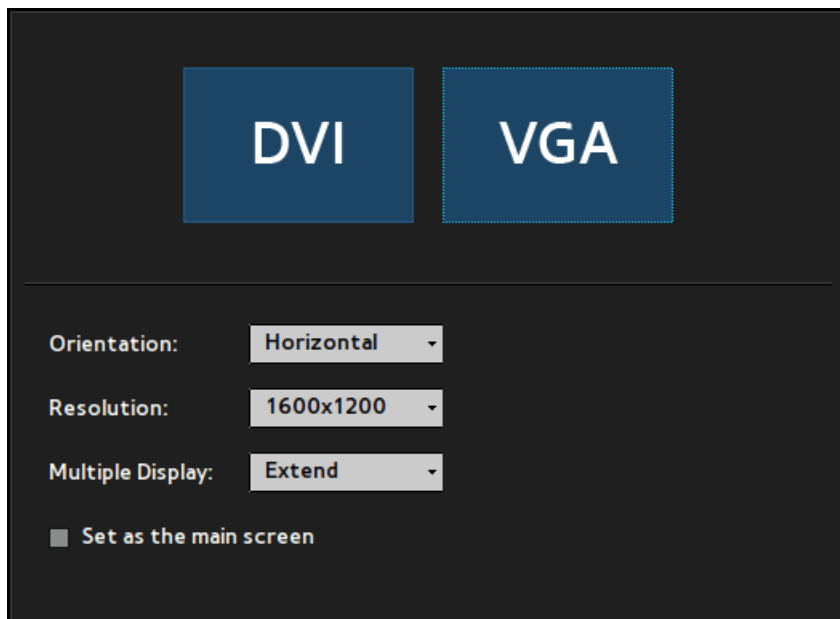

To set the selected display as the primary screen, select the **Set as the main screen** checkbox.



When only one display device is connected, the **Multiple Display** option is disabled.

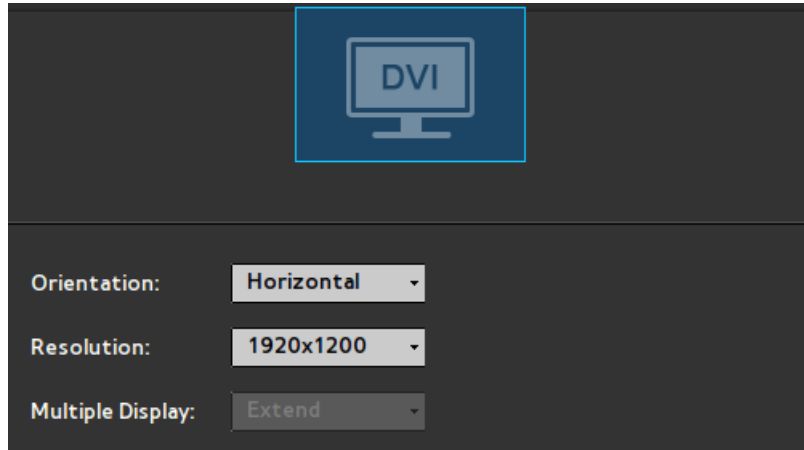

### Toolbar

Select whether to display the toolbar or enable the shortcut keys on the Client.

- **Always hide toolbar**

Hide the toolbar on the screen: select the checkbox and minimize the toolbar. To unhide the toolbar, press the corresponding shortcut key.

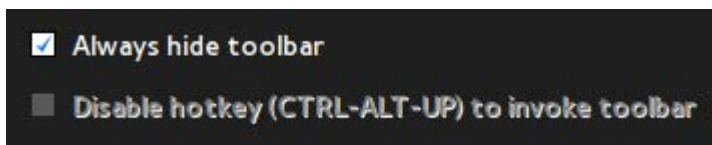

- **Disable hotkey(CTRL-ALT-UP) to invoke toolbar**

Shrink the toolbar by pressing the corresponding shortcut key (CTRL-ALT-UP). To expand the toolbar, click the arrow button on the minimized toolbar.

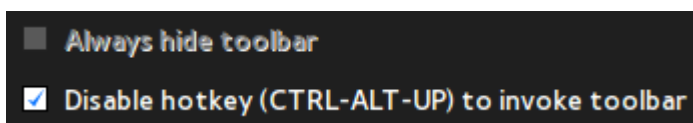

The two options above cannot be enabled at the same time.

### Sound

Adjust the sound on the Client.

- **Volume** : Adjust the volume using the scrollbar.
- **Mute** : Mute the sound.

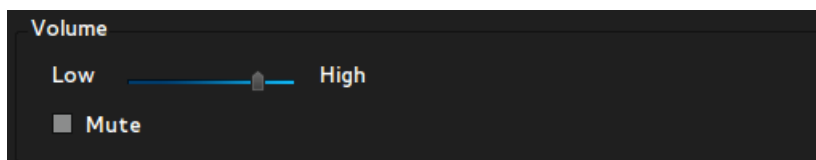

## Input

## 1 Keyboard

You can configure the keyboard settings for the Client.

- **Character Set** : Specify the character encoding method to use on the Client.
- **Keyboard Language** : Specify the keyboard language.
- **Repeat Rate** : Specify the keyboard sensitivity.

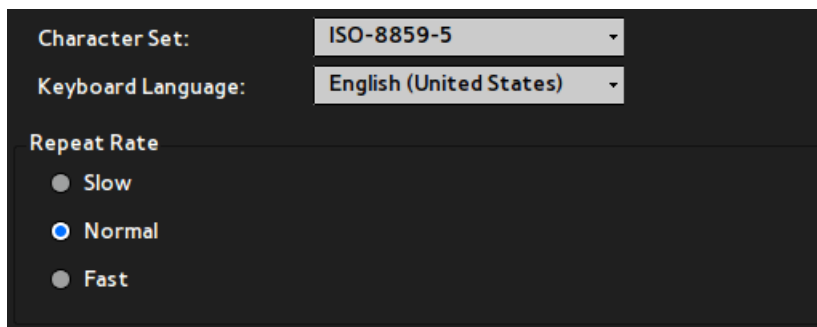

The screenshot shows a configuration panel for keyboard settings. It includes two dropdown menus: 'Character Set' set to 'ISO-8859-5' and 'Keyboard Language' set to 'English (United States)'. Below these is a 'Repeat Rate' section with three radio button options: 'Slow', 'Normal' (which is selected), and 'Fast'.

## 2 Mouse

You can configure the mouse settings for the Client.

- **Mouse Speed** : Configure the mouse movement sensitivity.
- **Buttons** : Activate the left-handed mouse mode.

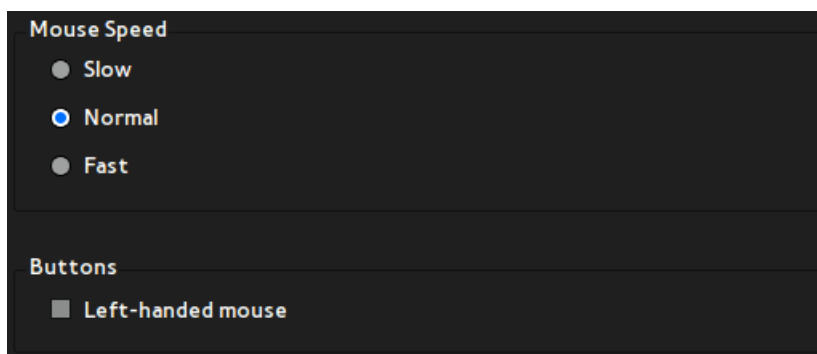

The screenshot shows a configuration panel for mouse settings. It features a 'Mouse Speed' section with three radio button options: 'Slow', 'Normal' (selected), and 'Fast'. Below this is a 'Buttons' section with a checkbox labeled 'Left-handed mouse' which is currently unchecked.

## Printer

## 1 LPDs

Configure the LPD-type printer settings.

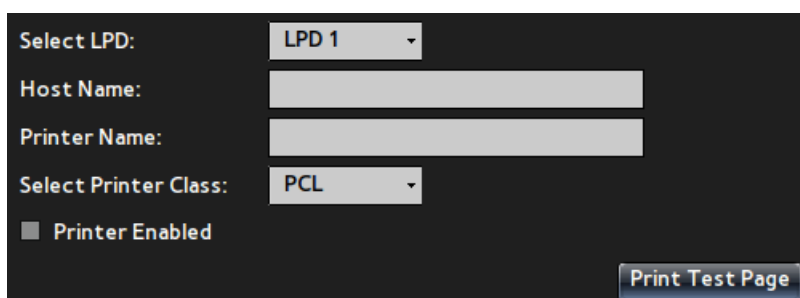

The screenshot shows a configuration panel for LPD-type printer settings. It includes four fields: 'Select LPD:' with a dropdown menu set to 'LPD 1', 'Host Name:' with an empty text input field, 'Printer Name:' with an empty text input field, and 'Select Printer Class:' with a dropdown menu set to 'PCL'. At the bottom left, there is a checkbox labeled 'Printer Enabled' which is unchecked. At the bottom right, there is a button labeled 'Print Test Page'.

## 2 SMBs

Configure the SMB-type printer settings.

Select SMBs: **SMB 1**

smb://

Authentication

Username:

Password:

Printer Enabled

Print Test Page

## Information

You can view the Client information.

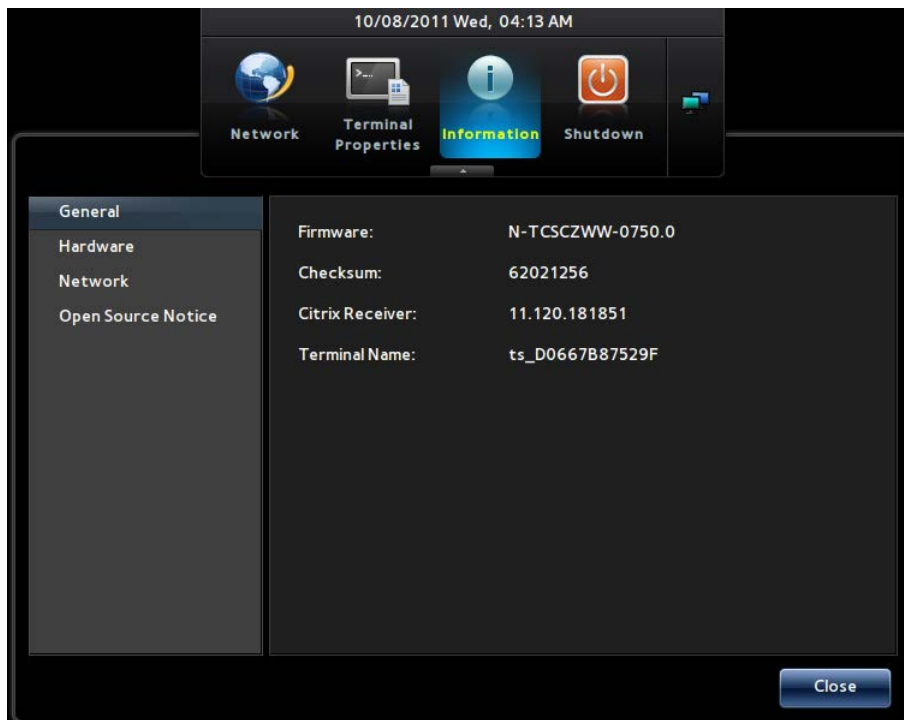

## General

- **Firmware** : View the version of the firmware on the Client.
- **Checksum** : View the checksum of the firmware on the Client.
- **Citrix Receiver** : View the version of the Citrix Receiver used on the Client.

- **Terminal Name** : View the **Terminal Name** of the Client.

Firmware:	N-TCSCZWW-0750.0
Checksum:	62021256
Citrix Receiver:	11.120.181851
Terminal Name:	ts_D0667B87529F

#### Hardware

- **CPU** : View information about the CPU on the Client.
- **CPU Busy** : View the current CPU usage on the Client.
- **Memory size** : View the total amount of memory on the Client.
- **Free Memory** : View the amount of memory currently available on the Client.
- **Resolution** : View the display resolution configured on the Client.
- **System up Time** : View the amount of time the Client has been running.

CPU:	AMD G-T44R Processor
CPU Busy:	17%
Memory size:	1650936 KB
Free Memory:	1416980 KB
Resolution:	1600x1200
System up Time	24 Min

#### Network

- **IP Address** : View the IP information configured on the Client.
- **Subnet Mask** : View the subnet mask configured on the Client.
- **Default Gateway** : View the **Default Gateway** configured on the Client.
- **DHCP Lease** : View the amount of time (in seconds) it takes for an IP address to be assigned when the Client uses DHCP.
- **Speed & Duplex** : View the speed and duplex information of the link that is used when the Client connects to a network.

- **Mac Address** : View the **Mac Address** of the network adapter on the Client.

IP Address :	192.168.0.67
Subnet Mask :	255.255.255.0
Default Gateway :	192.168.0.1
DHCP Lease :	N.A
Speed & Duplex :	100Mb/s & Full
Mac Address :	D0:66:7B:87:52:9F

### Open Source Notice

You can view details of the **Open Source** components used on the Client.

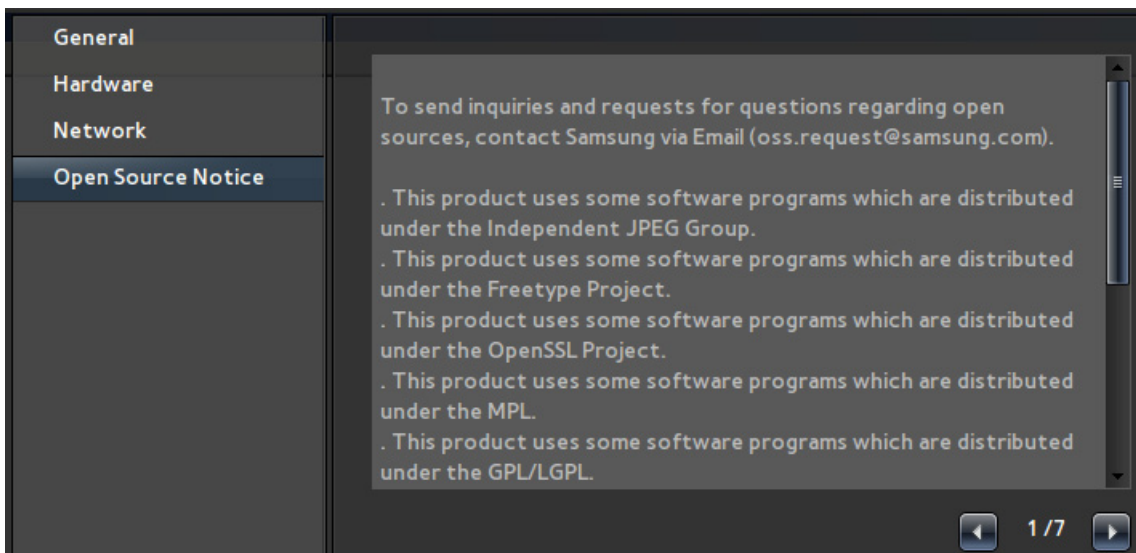

#### Open source license notice

In the case of using open source software, Open Source licenses are available on the product menu.

Open Source License Notice is written only English.

### Shutdown

You can log off, close, or restart the Client.

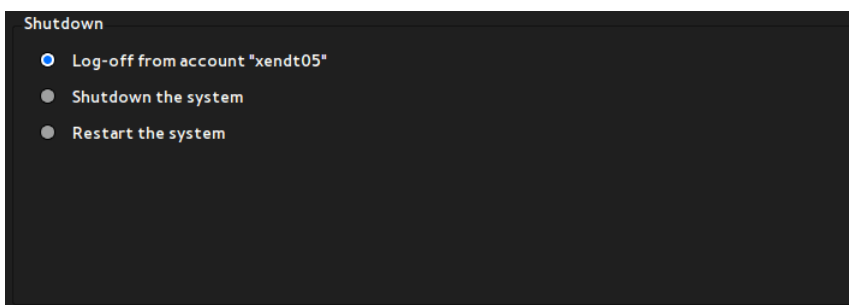

### 1 Log-off from account "\*\*\*\*"

Log off from the Client if you are logged on. This option is enabled only when you are logged on to the Client. To log off, select **Yes** in the **Notice** window.

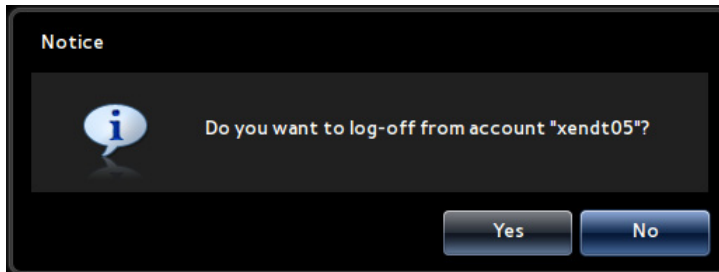

### 2 Shutdown the system

You can close the Client. To close the Client, select **Yes** in the **Notice** window.

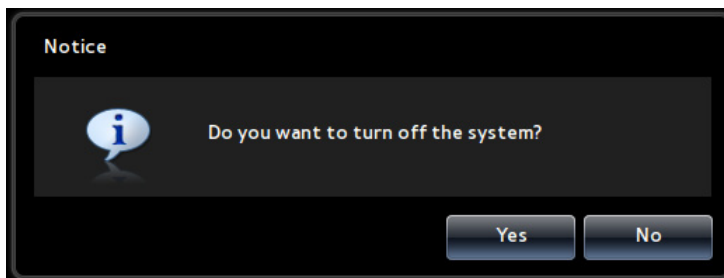

### 3 Restart the system

You can restart the Client. To restart the Client, select **Yes** in the **Notice** window.

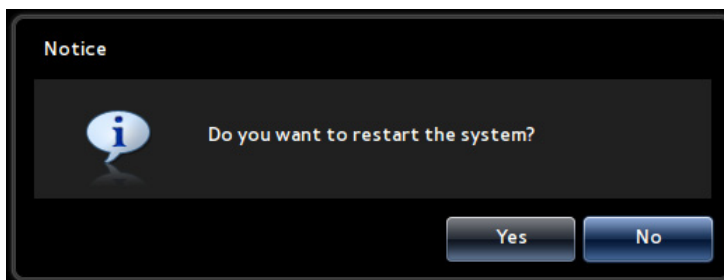



### Remote Desktop

You can view a list of desktops and applications (on the Citrix Server) the Client can connect to when logged on.

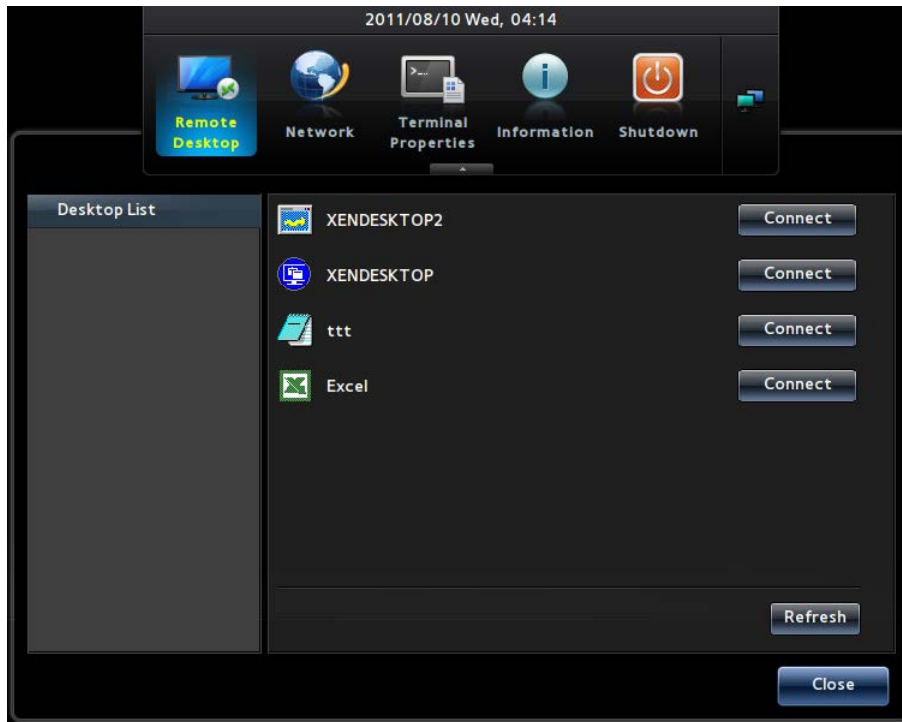

## Desktop List

### 1 Connect

You can connect to a desktop or application on the list by clicking the corresponding **Connect** button or double-clicking the desktop or application desired.



When a connection to a desktop or application is established, the **Connect** button for the desktop or application will be replaced by the **Disconnect** button in the **Desktop List**. The corresponding desktop or application row in the list will be highlighted as shown below.

You can connect to more than one desktop or application. The names of the desktops and applications connected will be highlighted.

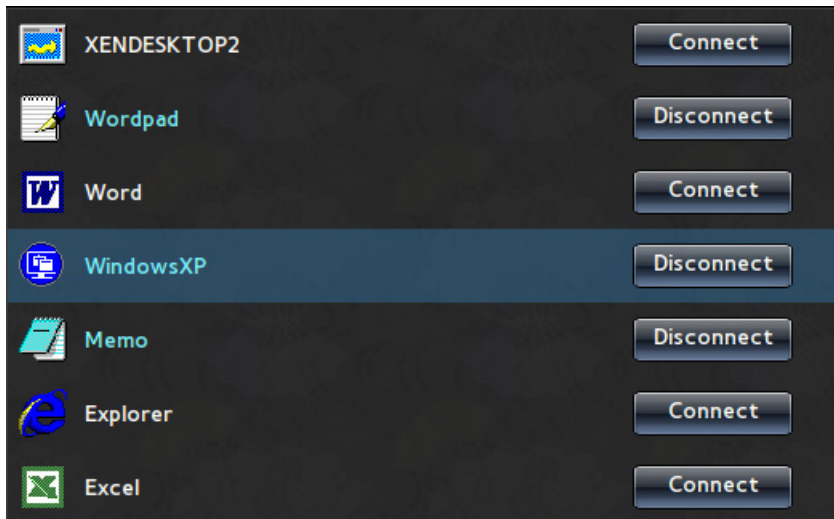

### 2 Disconnect

The **Disconnect** button disconnects the corresponding desktop or application connected. When the desktop or application is disconnected, a list of connected desktops or applications will appear if there are any.

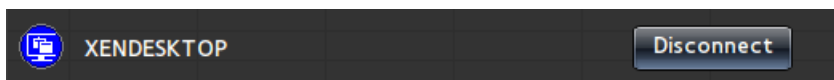

### 3 Refresh

To update the **Desktop List** that contains a list of desktops or applications on the Citrix Server, click **Refresh**.

#### 4 Reconnect

You can display desktops and applications that are not displayed even though they are connected to the Client. Double-click the desktop or application desired. The corresponding desktop or application row in the list will be highlighted.

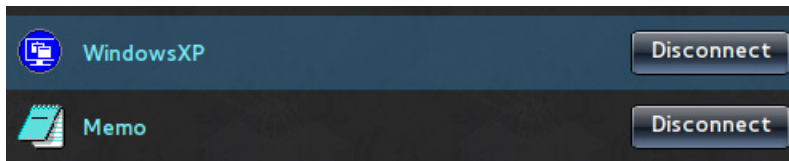

Double-click **Memo**. A notepad window will be displayed.



#### Status Icon

Network icon: Display the current network status using an icon.

- 1 Not connected to the network.

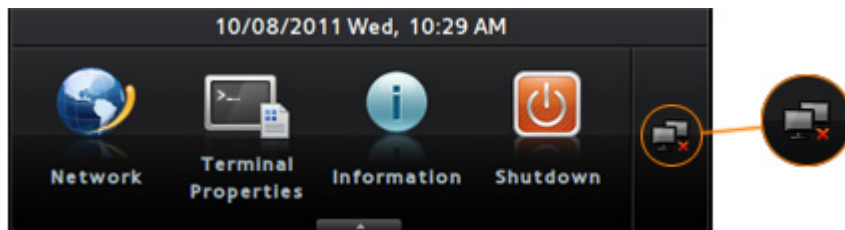

- 2 Attempting to connect to the network.

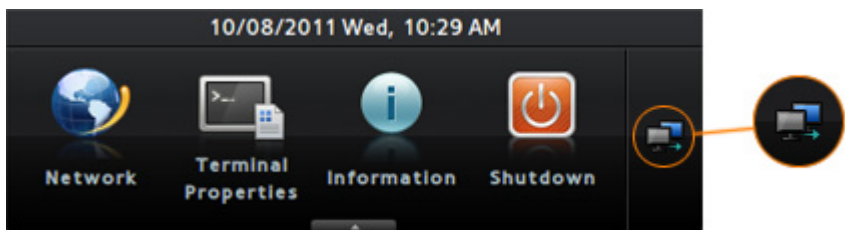

- 3 Connected to the network.

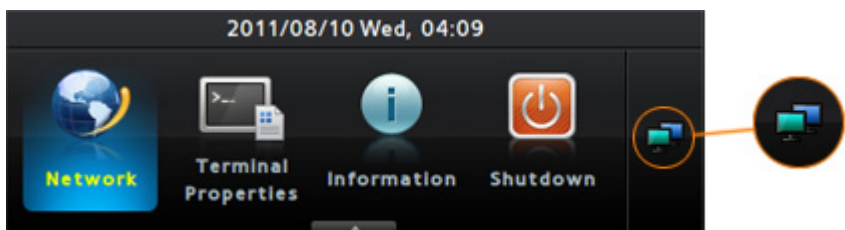

### Terminal Lock

This menu locks the **Network** and **Terminal Properties** options so that their settings cannot be changed.

The corresponding shortcut key is [CTRL + ALT + F6].

- How to lock the two options

Press and hold the shortcut key for a specified time (about 8 seconds).

When the lock is on, the options locked will be indicated on the toolbar as shown below.

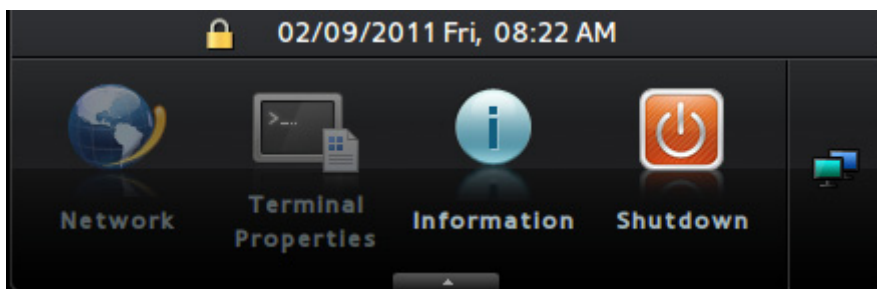

- How to unlock the two options

Press and hold the shortcut key for a specified time (about 8 seconds).

Note that you are prompted to enter the password in order to unlock the two options.

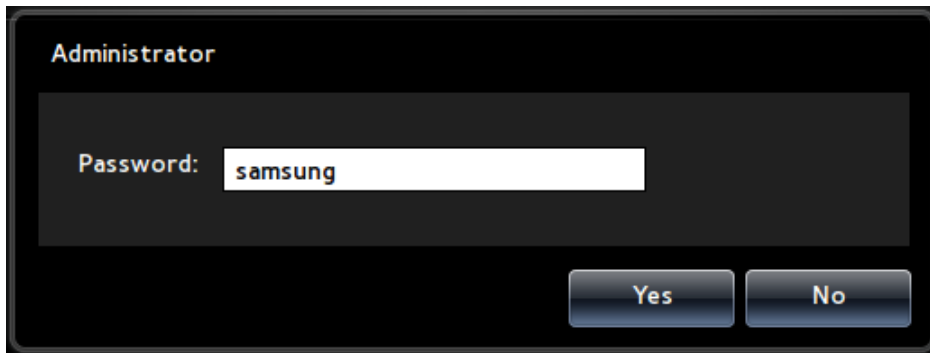

## 4.1 Requirements Before Contacting Samsung Customer Service Center

### 4.1.1 Check the following.

Sound issue	
There is no sound.	Check the connection of the audio cable or adjust the volume.
	Check the volume.
The volume is too low.	Adjust the volume.
	If the volume is still low after turning it up to the maximum level, adjust the volume in the audio settings program.

## 5.1 General

Model Name		TB-WH	TB-CH
Power Supply		This product uses 100 to 240V. Refer to the label at the back of the product as the standard voltage can vary in different countries.	
Monitor connectors		RGB OUT (D-Sub) port, DVI OUT port	
Server connector		LAN	
Speaker		1 W x 2	
USB		USB 2.0 x 6 (Down stream)	
Dimensions (W x H x D) / Weight		244.0 X 340.0 X 227.0 mm / 9.6 X 13.4 X 8.9 inches / 2.3 kg / 5.1 lb	
Environmental considerations	Operating	Temperature : 50°F ~ 122°F (10°C ~ 50°C) Humidity : 10 % – 90 %, non-condensing	
	Storage	Temperature : -4°F ~ 113°F (-20°C ~ 45°C) Humidity : 5 % – 90 %, non-condensing	
VESA (V x H)		75 x 75 mm / 100 x 100 mm	



The above specifications are subject to change without notice to improve quality.



This device is a Class B digital apparatus.

(USA only)

Dispose unwanted electronics through an approved recycler.

To find the nearest recycling location, go to our website:

[www.samsung.com/recyclingdirect](http://www.samsung.com/recyclingdirect) or call, (877) 278 - 0799

CALIFORNIA USA ONLY (Applicable for networking models only.)

This Perchlorate warning applies only to primary CR(Manganese Dioxide) Lithium coin cells in the product sold or distributed ONLY in California USA

"Perchlorate Material - special handling may apply, See [www.dtsc.ca.gov/hazardouswaste/perchlorate](http://www.dtsc.ca.gov/hazardouswaste/perchlorate)."

## 5.2 Power consumption

PowerSaver	Normal operation mode		Stand by (S3)	Power off (S5) (Power button off)	Power off (Power switch off)
	Typical	Rating			
Power lamp	On		Off	Off	Off
Power Consumption	11 W	35 W	Less than 2 W	Less than 2 W	0 W



- The power consumption level can vary in different operating conditions or when settings are changed.
- To reduce the power consumption to 0 watts, turn off the switch on the adapter or disconnect the power cable. Be sure to disconnect the power cable when you will not be using the product for an extended period of time. To reduce the power consumption to 0 watts when the power switch is not available, disconnect the power cable.

## Contact SAMSUNG WORLDWIDE



If you have any questions or comments relating to Samsung products, please contact the SAMSUNG customer care center.

NORTH AMERICA		
U.S.A	1-800-SAMSUNG (726-7864)	<a href="http://www.samsung.com">http://www.samsung.com</a>
CANADA	1-800-SAMSUNG (726-7864)	<a href="http://www.samsung.com/ca">http://www.samsung.com/ca</a> <a href="http://www.samsung.com/ch_fr">http://www.samsung.com/ch_fr</a> (French)
MEXICO	01-800-SAMSUNG (726-7864)	<a href="http://www.samsung.com">http://www.samsung.com</a>

LATIN AMERICA		
ARGENTINA	0800-333-3733	<a href="http://www.samsung.com">http://www.samsung.com</a>
BRAZIL	0800-124-421 4004-0000	<a href="http://www.samsung.com">http://www.samsung.com</a>
BOLIVIA	800-10-7260	<a href="http://www.samsung.com">http://www.samsung.com</a>
CHILE	800-SAMSUNG (726-7864) From mobile 02-482 82 00	<a href="http://www.samsung.com">http://www.samsung.com</a>
COLOMBIA	01-8000112112	<a href="http://www.samsung.com">http://www.samsung.com</a>
COSTA RICA	0-800-507-7267	<a href="http://www.samsung.com">http://www.samsung.com</a>
DOMINICA	1-800-751-2676	<a href="http://www.samsung.com">http://www.samsung.com</a>
ECUADOR	1-800-10-7267	<a href="http://www.samsung.com">http://www.samsung.com</a>
EL SALVADOR	800-6225	<a href="http://www.samsung.com">http://www.samsung.com</a>
GUATEMALA	1-800-299-0013	<a href="http://www.samsung.com">http://www.samsung.com</a>
HONDURAS	800-27919267	<a href="http://www.samsung.com">http://www.samsung.com</a>
JAMAICA	1-800-234-7267	<a href="http://www.samsung.com">http://www.samsung.com</a>
NICARAGUA	00-1800-5077267	<a href="http://www.samsung.com">http://www.samsung.com</a>
PANAMA	800-7267	<a href="http://www.samsung.com">http://www.samsung.com</a>
PERU	0-800-777-08	<a href="http://www.samsung.com">http://www.samsung.com</a>
PUERTO RICO	1-800-682-3180	<a href="http://www.samsung.com">http://www.samsung.com</a>
TRINIDAD & TOBAGO	1-800-SAMSUNG (726-7864)	<a href="http://www.samsung.com">http://www.samsung.com</a>
VENEZUELA	0-800-100-5303	<a href="http://www.samsung.com">http://www.samsung.com</a>



# Appendix

EUROPE		
ALBANIA	42 27 5755	<a href="http://www.samsung.com">http://www.samsung.com</a>
AUSTRIA	0810 - SAMSUNG (7267864, € 0.07/min)	<a href="http://www.samsung.com">http://www.samsung.com</a>
BELGIUM	02-201-24-18	<a href="http://www.samsung.com/be">http://www.samsung.com/be</a> (Dutch) <a href="http://www.samsung.com/be_fr">http://www.samsung.com/be_fr</a> (French)
BOSNIA	05 133 1999	<a href="http://www.samsung.com">http://www.samsung.com</a>
BULGARIA	07001 33 11	<a href="http://www.samsung.com">http://www.samsung.com</a>
CROATIA	062 SAMSUNG (062 726 7864)	<a href="http://www.samsung.com">http://www.samsung.com</a>
CZECH	800 - SAMSUNG (800-726786)	<a href="http://www.samsung.com">http://www.samsung.com</a>
	Samsung Electronics Czech and Slovak, s.r.o., Oasis Florenc, Sokolovská 394/17, 180 00, Praha 8	
DENMARK	70 70 19 70	<a href="http://www.samsung.com">http://www.samsung.com</a>
FINLAND	030 - 6227 515	<a href="http://www.samsung.com">http://www.samsung.com</a>
FRANCE	01 48 63 00 00	<a href="http://www.samsung.com">http://www.samsung.com</a>
GERMANY	01805 - SAMSUNG (726-7864,€ 0,14/Min)	<a href="http://www.samsung.com">http://www.samsung.com</a>
CYPRUS	From landline : 8009 4000	<a href="http://www.samsung.com">http://www.samsung.com</a>
GREECE	From landline : 80111-SAMSUNG (7267864) From landline & mobile : (+30) 210 6897691	<a href="http://www.samsung.com">http://www.samsung.com</a>
HUNGARY	06-80-SAMSUNG (726-7864)	<a href="http://www.samsung.com">http://www.samsung.com</a>
ITALIA	800-SAMSUNG (726-7864)	<a href="http://www.samsung.com">http://www.samsung.com</a>
KOSOVO	+381 0113216899	<a href="http://www.samsung.com">http://www.samsung.com</a>
LUXEMBURG	261 03 710	<a href="http://www.samsung.com">http://www.samsung.com</a>
MACEDONIA	023 207 777	<a href="http://www.samsung.com">http://www.samsung.com</a>
MONTENEGRO	020 405 888	<a href="http://www.samsung.com">http://www.samsung.com</a>
NETHERLANDS	0900 - SAMSUNG (0900-7267864) (€ 0,10/Min)	<a href="http://www.samsung.com">http://www.samsung.com</a>
NORWAY	815-56 480	<a href="http://www.samsung.com">http://www.samsung.com</a>
POLAND	0 801-1SAMSUNG (172-678) +48 22 607-93-33	<a href="http://www.samsung.com">http://www.samsung.com</a>

# Appendix

EUROPE		
PORTUGAL	808 20 - SAMSUNG (808 20 7267)	<a href="http://www.samsung.com">http://www.samsung.com</a>
RUMANIA	From landline : 08010-SAMSUNG (7267864) From landline & mobile : (+40) 21 206 01 10	<a href="http://www.samsung.com">http://www.samsung.com</a>
SERBIA	0700 Samsung (0700 726 7864)	<a href="http://www.samsung.com">http://www.samsung.com</a>
SLOVAKIA	0800 - SAMSUNG (0800-726 786)	<a href="http://www.samsung.com">http://www.samsung.com</a>
SPAIN	902 - 1 - SAMSUNG (902 172 678)	<a href="http://www.samsung.com">http://www.samsung.com</a>
SWEDEN	0771 726 7864 (SAMSUNG)	<a href="http://www.samsung.com">http://www.samsung.com</a>
SWITZERLAND	0848-SAMSUNG (7267864, CHF 0.08/min)	<a href="http://www.samsung.com/ch">http://www.samsung.com/ch</a> <a href="http://www.samsung.com/ch_fr">http://www.samsung.com/ch_fr</a> (French)
U.K	0330 SAMSUNG (7267864)	<a href="http://www.samsung.com">http://www.samsung.com</a>
EIRE	0818 717100	<a href="http://www.samsung.com">http://www.samsung.com</a>
LITHUANIA	8-800-77777	<a href="http://www.samsung.com">http://www.samsung.com</a>
LATVIA	8000-7267	<a href="http://www.samsung.com">http://www.samsung.com</a>
ESTONIA	800-7267	<a href="http://www.samsung.com">http://www.samsung.com</a>
TURKEY	444 77 11	<a href="http://www.samsung.com">http://www.samsung.com</a>

CIS		
RUSSIA	8-800-555-55-55	<a href="http://www.samsung.com">http://www.samsung.com</a>
GEORGIA	8-800-555-555	<a href="http://www.samsung.com">http://www.samsung.com</a>
ARMENIA	0-800-05-555	<a href="http://www.samsung.com">http://www.samsung.com</a>
AZERBAIJAN	088-55-55-555	<a href="http://www.samsung.com">http://www.samsung.com</a>
KAZAKHSTAN	8-10-800-500-55-500 (GSM: 7799)	<a href="http://www.samsung.com">http://www.samsung.com</a>
UZBEKISTAN	8-10-800-500-55-500	<a href="http://www.samsung.com">http://www.samsung.com</a>
KYRGYZSTAN	00-800-500-55-500	<a href="http://www.samsung.com">http://www.samsung.com</a>
TADJIKISTAN	8-10-800-500-55-500	<a href="http://www.samsung.com">http://www.samsung.com</a>
MONGOLIA	-	<a href="http://www.samsung.com">http://www.samsung.com</a>

# Appendix

CIS		
UKRAINE	0-800-502-000	<a href="http://www.samsung.com/ua">http://www.samsung.com/ua</a> <a href="http://www.samsung.com/ua_ru">http://www.samsung.com/ua_ru</a>
BELARUS	810-800-500-55-500	<a href="http://www.samsung.com">http://www.samsung.com</a>
MOLDOVA	00-800-500-55-500	<a href="http://www.samsung.com">http://www.samsung.com</a>

ASIA PACIFIC		
AUSTRALIA	1300 362 603	<a href="http://www.samsung.com">http://www.samsung.com</a>
NEW ZEALAND	0800 SAMSUNG (0800 726 786)	<a href="http://www.samsung.com">http://www.samsung.com</a>
CHINA	400-810-5858	<a href="http://www.samsung.com">http://www.samsung.com</a>
HONG KONG	(852) 3698 - 4698	<a href="http://www.samsung.com/hk">http://www.samsung.com/hk</a> <a href="http://www.samsung.com/hk_en/">http://www.samsung.com/hk_en/</a>
INDIA	1800 1100 11 3030 8282 1800 3000 8282 1800 266 8282	<a href="http://www.samsung.com">http://www.samsung.com</a>
INDONESIA	0800-112-8888 021-5699-7777	<a href="http://www.samsung.com">http://www.samsung.com</a>
JAPAN	0120-327-527	<a href="http://www.samsung.com">http://www.samsung.com</a>
MALAYSIA	1800-88-9999	<a href="http://www.samsung.com">http://www.samsung.com</a>
PHILIPPINES	1-800-10-SAMSUNG (726-7864) for PLDT 1-800-3-SAMSUNG (726-7864) for Digitel 1-800-8-SAMSUNG (726-7864) for Globe 02-5805777	<a href="http://www.samsung.com">http://www.samsung.com</a>
SINGAPORE	1800-SAMSUNG (726-7864)	<a href="http://www.samsung.com">http://www.samsung.com</a>
THAILAND	1800-29-3232 02-689-3232	<a href="http://www.samsung.com">http://www.samsung.com</a>
TAIWAN	0800-329-999 0266-026-066	<a href="http://www.samsung.com">http://www.samsung.com</a>
VIETNAM	1 800 588 889	<a href="http://www.samsung.com">http://www.samsung.com</a>

MIDDLE EAST		
IRAN	021-8255	<a href="http://www.samsung.com">http://www.samsung.com</a>
OMAN	800-SAMSUNG (726-7864)	<a href="http://www.samsung.com">http://www.samsung.com</a>
KUWAIT	183-2255	<a href="http://www.samsung.com">http://www.samsung.com</a>
BAHRAIN	8000-4726	<a href="http://www.samsung.com">http://www.samsung.com</a>
EGYPT	08000-726786	<a href="http://www.samsung.com">http://www.samsung.com</a>
JORDAN	800-22273	<a href="http://www.samsung.com">http://www.samsung.com</a>
MOROCCO	080 100 2255	<a href="http://www.samsung.com">http://www.samsung.com</a>
SAUDI ARABIA	9200-21230	<a href="http://www.samsung.com">http://www.samsung.com</a>
U.A.E	800-SAMSUNG (726-7864)	<a href="http://www.samsung.com">http://www.samsung.com</a>

AFRICA		
CAMEROON	7095- 0077	<a href="http://www.samsung.com">http://www.samsung.com</a>
COTE D'IVOIRE	8000 0077	<a href="http://www.samsung.com">http://www.samsung.com</a>
GHANA	0800-10077 0302-200077	<a href="http://www.samsung.com">http://www.samsung.com</a>
KENYA	0800 724 000	<a href="http://www.samsung.com">http://www.samsung.com</a>
NIGERIA	0800-726-7864	<a href="http://www.samsung.com">http://www.samsung.com</a>
SENEGAL	800-00-0077	<a href="http://www.samsung.com">http://www.samsung.com</a>
SOUTH AFRICA	0860-SAMSUNG (726-7864)	<a href="http://www.samsung.com">http://www.samsung.com</a>
TANZANIA	0685 88 99 00	<a href="http://www.samsung.com">http://www.samsung.com</a>
UGANDA	0800 300 300	<a href="http://www.samsung.com">http://www.samsung.com</a>

## Correct Disposal

### Correct Disposal of This Product (Waste Electrical & Electronic Equipment)



(Applicable in the European Union and other European countries with separate collection systems)

This marking on the product, accessories or literature indicates that the product and its electronic accessories (e.g. charger, headset, USB cable) should not be disposed of with other household waste at the end of their working life. To prevent possible harm to the environment or human health from uncontrolled waste disposal, please separate these items from other types of waste and recycle them responsibly to promote the sustainable reuse of material resources.

Household users should contact either the retailer where they purchased this product, or their local government office, for details of where and how they can take these items for environmentally safe recycling.

Business users should contact their supplier and check the terms and conditions of the purchase contract. This product and its electronic accessories should not be mixed with other commercial wastes for disposal.

### Correct disposal of batteries in this product



(Applicable in the European Union and other European countries with separate battery return systems.)

The marking on the battery, manual or packaging indicates that the battery in this product should not be disposed of with other household waste. Where marked, the chemical symbols Hg, Cd or Pb indicate that the battery contains mercury, cadmium or lead above the reference levels in EC Directive 2006/66.

The battery incorporated in this product is not user replaceable. For information on its replacement, please contact your service provider. Do not attempt to remove the battery or dispose it in a fire. Do not disassemble, crush, or puncture the battery. If you intend to discard the product, the waste collection site will take the appropriate measures for the recycling and treatment of the product, including the battery.

# Index

---

## A

About Zero Client 39

## C

Checking the Contents 13

Connection to Use the Zero Client 40

Connection to Use Windows Embedded  
Standard 7 23

Contact SAMSUNG WORLDWIDE 72

Copyright 5

Correct Disposal 77

## G

General 70

## I

Installation 18

## M

MagicRMS Pro 38

## P

Parts 15

Power consumption 71

## R

Requirements Before Contacting Samsung  
Customer Service Center 69

## S

Safety Precautions 6

## U

Using the Zero Client 45

## W

What is Windows Embedded Standard 7  
Client? 22