

Dell PowerEdge T360

Installation and Service Manual

Notes, cautions, and warnings

 **NOTE:** A NOTE indicates important information that helps you make better use of your product.

 **CAUTION:** A CAUTION indicates either potential damage to hardware or loss of data and tells you how to avoid the problem.

 **WARNING:** A WARNING indicates a potential for property damage, personal injury, or death.

Chapter 1: About this document	7
Chapter 2: Dell PowerEdge T360 system overview	8
Front view of the system.....	9
Rear view of the system.....	13
Inside the system	17
Locating the Express Service Code and Service Tag.....	17
System information labels.....	18
Chapter 3: Technical specifications	19
Chassis dimensions.....	20
System weight.....	20
Processor specifications.....	20
PSU specifications.....	21
Cooling fan specifications.....	22
Supported operating systems.....	22
System battery specifications.....	22
Expansion card riser specifications.....	23
Memory specifications.....	23
Storage controller specifications.....	23
Drives.....	24
Optical drives.....	24
GPU specifications.....	24
Ports and connectors specifications.....	24
NIC port specifications.....	24
Serial connector specifications.....	24
Ports specifications.....	25
Video specifications.....	25
Environmental specifications.....	26
Thermal restriction matrix.....	27
Thermal air restrictions.....	28
Chapter 4: Initial system setup and configuration	29
Setting up the system.....	29
iDRAC configuration.....	29
Options to set up iDRAC IP address.....	29
Options to log in to iDRAC.....	29
Resources to install operating system.....	30
Options to download drivers and firmware	30
Options to download and install OS drivers	31
Downloading drivers and firmware.....	31
Chapter 5: Pre-operating system management applications	32
System Setup.....	32

System BIOS.....	33
iDRAC Settings.....	48
Device Settings.....	48
Service Tag Settings.....	48
Dell Lifecycle Controller.....	48
Embedded system management.....	48
Boot Manager.....	48
PXE boot.....	49
Chapter 6: Minimum to POST	50
Minimum configuration to POST	50
Configuration validation.....	50
Error messages.....	51
Chapter 7: Installing and removing system components	52
Safety instructions.....	52
Before working inside your system	52
After working inside your system.....	52
Recommended tools.....	53
Optional front bezel.....	53
Removing the front bezel.....	53
Installing the front bezel.....	54
System feet.....	55
Removing the system feet.....	55
Installing the system feet.....	56
System cover.....	57
Removing the system cover.....	57
Installing the system cover.....	58
Air shroud.....	60
Removing the air shroud.....	60
Installing the air shroud.....	60
PCIe air shroud.....	62
Removing the PCIe air shroud.....	62
Installing the PCIe air shroud.....	62
Intrusion switch.....	63
Removing the intrusion switch module.....	63
Installing the intrusion switch module.....	64
Drives.....	65
Removing a drive blank.....	65
Installing a drive blank.....	66
Removing a drive carrier.....	66
Installing the drive carrier.....	67
Removing the drive from the drive carrier.....	68
Installing the drive into the drive carrier.....	69
Removing a 3.5-inch drive adapter from a 3.5-inch drive carrier.....	70
Installing a 3.5-inch adapter into a 3.5-inch drive carrier.....	71
Removing a 2.5-inch drive from the 3.5-inch drive adapter.....	72
Installing a 2.5-inch drive into the 3.5-inch drive adapter.....	73
Optional optical drive.....	74

Removing the optical drive blank.....	74
Installing the optical drive blank.....	75
Removing the optical drive.....	76
Installing the optical drive.....	77
Drive backplane.....	78
Drive backplane.....	78
Removing the drive backplane	79
Installing the drive backplane.....	80
Cooling fans.....	81
Removing the cooling fan.....	81
Installing the cooling fan.....	83
Cable routing.....	84
System memory.....	87
General memory module installation guidelines.....	87
Removing a memory module.....	87
Installing a memory module.....	88
Processor and heat sink	89
Removing the heat sink.....	89
Removing the processor.....	90
Installing the processor.....	91
Installing the heat sink.....	92
Expansion cards and expansion card risers.....	94
Expansion card installation guidelines.....	94
Removing an expansion card.....	95
Installing an expansion card.....	97
Removing the GPU.....	98
Installing the GPU.....	100
Optional BOSS-N1 module.....	101
Removing the BOSS-N1 module.....	101
Installing the BOSS-N1 module.....	103
Removing the BOSS-N1 card carrier.....	104
Installing the BOSS-N1 card carrier.....	106
Power supply unit.....	108
Hot spare feature.....	108
Removing a power supply unit blank.....	109
Installing a power supply unit blank.....	109
Removing a power supply unit.....	110
Installing a power supply unit.....	111
Removing a cabled PSU.....	112
Installing the cabled PSU.....	114
Power interposer board.....	115
Removing the power interposer board.....	115
Installing the power interposer board.....	116
System battery	117
Replacing the system battery.....	117
System board.....	119
Removing the system board.....	119
Installing the system board.....	120
Restoring the system using Easy Restore.....	121
Manually update the Service Tag.....	122

Trusted Platform Module.....	122
Upgrading the Trusted Platform Module.....	122
Initializing TPM for users.....	123
Initializing the TPM 2.0 for users.....	123
Control panel.....	124
Removing the control panel assembly.....	124
Installing the control panel assembly.....	127
Chapter 8: Upgrade Kits.....	131
BOSS-N1 module kit.....	131
GPU kit.....	134
Filter bezel kit.....	134
Chapter 9: Jumpers and connectors.....	137
System board layout.....	137
System board jumper settings.....	138
Disabling a forgotten password.....	139
Chapter 10: System diagnostics and indicator codes.....	140
System health and system ID indicator codes.....	140
iDRAC Direct LED indicator codes.....	140
NIC indicator codes.....	141
Power supply unit indicator codes.....	141
Drive indicator codes.....	143
Using system diagnostics.....	143
Dell Embedded System Diagnostics.....	144
Chapter 11: System board diagnostic LED indicators.....	145
Chapter 12: Getting help.....	152
Recycling or End-of-Life service information.....	152
Contacting Dell Technologies.....	152
Accessing system information by using QRL.....	152
Quick Resource Locator for PowerEdge T360 system.....	153
Receiving automated support with Secure Connect Gateway (SCG).....	153
Chapter 13: Documentation resources.....	154

About this document

This document provides an overview about the system, information about installing and replacing components, diagnostic tools, and guidelines to be followed while installing certain components.

Dell PowerEdge T360 system overview

The PowerEdge T360 system is a single-socket 4.5U tower server that supports:

- One Intel Xeon E-2400 series processor with up to eight cores or Intel Pentium G7400/ G7400T processor with up to two cores
- Four UDIMM slots
- A Cabled AC or two redundant AC or DC power supply units
- Up to 8 x 3.5-inch SAS/SATA HDD/SSD drives
- Up to 4 x 3.5-inch SATA HDD/SSD drives
- Up to 8 x 2.5-inch SAS/SATA HDD/SSD drives with 3.5-inch to 2.5-inch adapter

 **NOTE:** All instances of SAS and SATA drives are referred to as drives in this document, unless specified otherwise.

 **CAUTION:** Do not install GPUs, network cards, or other PCIe devices on your system that are not validated and tested by Dell. Damage caused by unauthorized and invalidated hardware installation will null and void the system warranty.

Topics:

- [Front view of the system](#)
- [Rear view of the system](#)
- [Inside the system](#)
- [Locating the Express Service Code and Service Tag](#)
- [System information labels](#)

Front view of the system

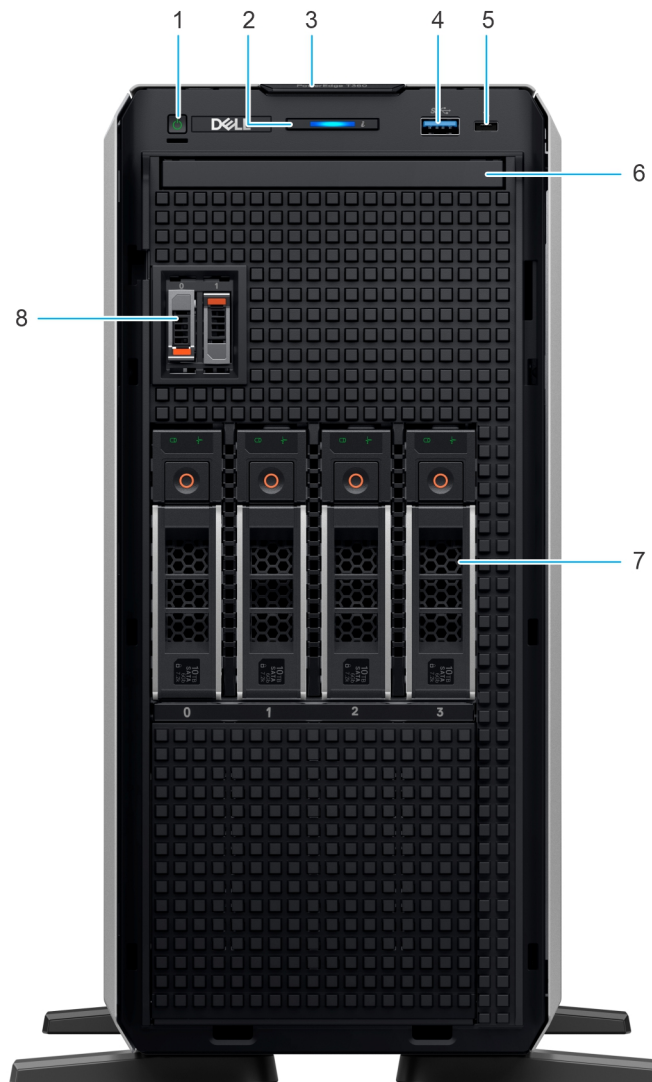

Figure 1. Front view of 4 x 3.5-inch drive system

Table 1. Features available on the front of the system





Item	Ports, panels, and slots	Icon	Description
1	Power button		Indicates if the system is powered on or off. Press the power button to manually power on or off the system.
2	Status LED indicators		Indicates the status of the system. For more information, see the Status LED indicators section.
3	Express Service Tag	N/A	A slide-out label panel that contains the Express Service Tag that has system information such as Service Tag, NIC, MAC address, and so on. If you have opted for

Table 1. Features available on the front of the system (continued)

Item	Ports, panels, and slots	Icon	Description
			the secure default access to iDRAC, the Information tag will also contain the iDRAC secure default password.
4	USB 3.2 port		Supports USB 3.2 compliant devices
5	iDRAC Direct (Micro-AB USB) port		The iDRAC Direct (Micro-AB USB) port enables you to access the iDRAC direct Micro-AB USB features. For more information, see the Integrated Dell Remote Access Controller User's Guide at PowerEdge Manuals .
6	Optical drive	N/A	Enables you to retrieve and store data on optical discs such as compact discs (CD) and digital versatile discs (DVD). For more information, see the Technical specifications section.
7	Drive Bay	N/A	Enables you to install SAS/SATA drives that are supported on your system.
8	BOSS-N1 (optional)	N/A	BOSS-N1 (optional) for internal system boot.

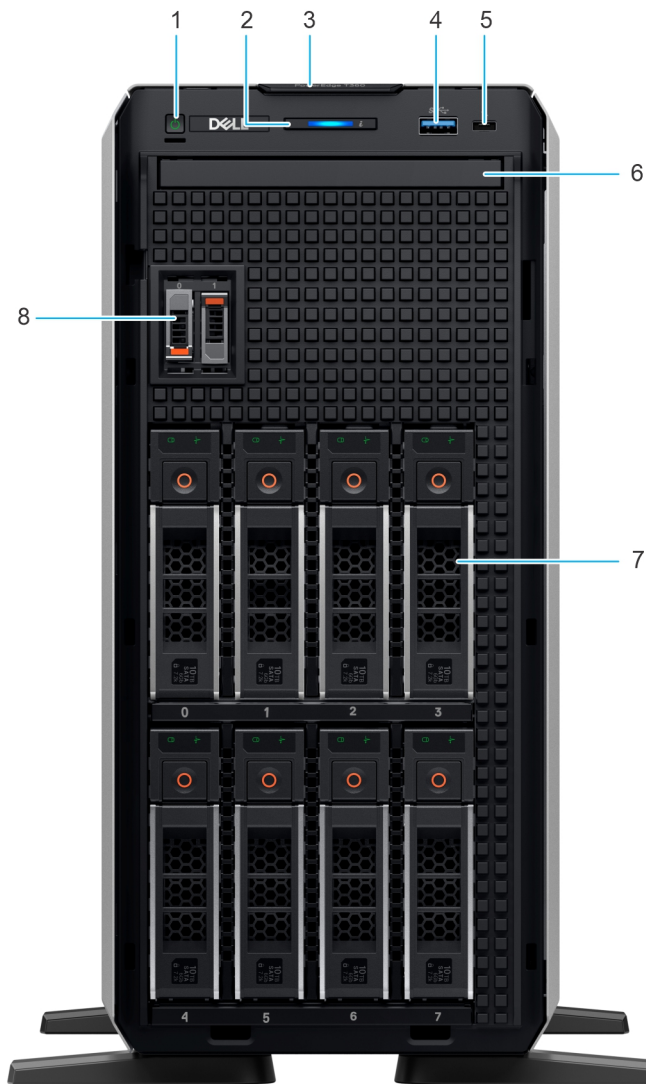

Figure 2. Front view of 8 x 3.5-inch drive system

Table 2. Features available on the front of the system





Item	Ports, panels, and slots	Icon	Description
1	Power button		Indicates if the system is powered on or off. Press the power button to manually power on or off the system.
2	Status LED indicators		Indicates the status of the system. For more information, see the Status LED indicators section.
3	Express Service Tag	N/A	A slide-out label panel that contains the Express Service Tag that has system information such as Service Tag, NIC, MAC address, and so on. If you have opted for the secure default access to iDRAC, the Information tag

Table 2. Features available on the front of the system (continued)

Item	Ports, panels, and slots	Icon	Description
			will also contain the iDRAC secure default password.
4	USB 3.2 port		Supports USB 3.2 compliant devices
5	iDRAC Direct (Micro-AB USB) port		The iDRAC Direct (Micro-AB USB) port enables you to access the iDRAC direct Micro-AB USB features. For more information, see the Integrated Dell Remote Access Controller User's Guide at PowerEdge Manuals .
6	Optical drive	N/A	Enables you to retrieve and store data on optical discs such as compact discs (CD) and digital versatile discs (DVD). For more information, see the Technical specifications section.
7	Drive Bay	N/A	Enables you to install SAS/SATA drives that are supported on your system.
8	BOSS-N1 (optional)	N/A	BOSS-N1 (optional) for internal system boot.

Rear view of the system

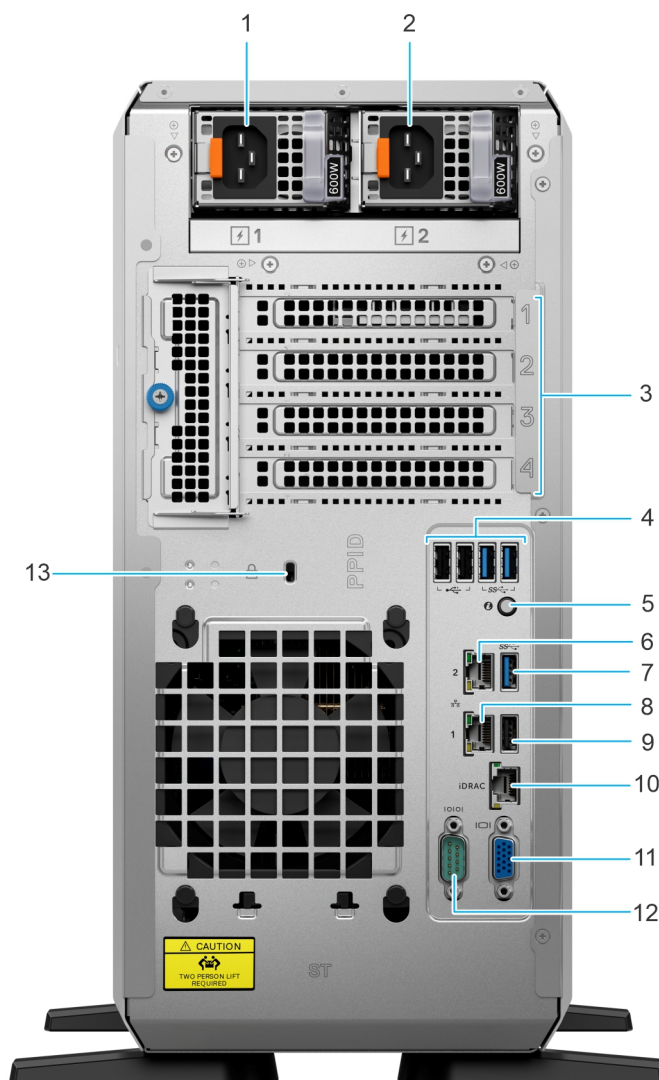







Figure 3. Rear view of the system

Table 3. Features available at the rear of the system

Item	Ports, panels, or slots	Icon	Description
1	Power supply unit (PSU 1)		PSU1 is the primary PSU of the system.
2	Power supply unit (PSU 2)		PSU2 is the secondary PSU of the system.
3	PCIe expansion card slots (4)	N/A	Enables you to connect PCI express expansion cards.
4	2 x USB 2.0 + 2 x USB 3.2 ports		Supports USB 2.0 and USB 3.2 compliant devices.
5	System Identification (ID) button		The System Identification (ID) button is available at the rear of the system. Press the button to identify a system by turning on the system ID button. You can also use the

Table 3. Features available at the rear of the system (continued)

Item	Ports, panels, or slots	Icon	Description
			system ID button to reset iDRAC and to access BIOS using the step-through mode. When pressed, the system ID LED in the back panel blinks until either the front or rear button is pressed again. Press the button to toggle between on or off mode.
6	NIC port (2)		The NIC ports that are integrated on the LOM card provide network connectivity which is connected to the system board.
7	USB 3.2 port		Supports USB 3.2 compliant devices.
8	NIC port (1)		The NIC ports that are integrated on the LOM card provide network connectivity which is connected to the system board.
9	USB 2.0 port		Supports USB 2.0 compliant devices.
10	Dedicated iDRAC Ethernet port	iDRAC	Enables you to remotely access iDRAC. For more information, see the Integrated Dell Remote Access Controller User's Guide at PowerEdge Manuals .
11	VGA port		Enables you to connect a display device to the system.
12	Serial port		Enables you to connect a serial device to the system.
13	Kensington lock slot	N/A	Enables you to connect security cable to prevent unauthorized movement of your system.

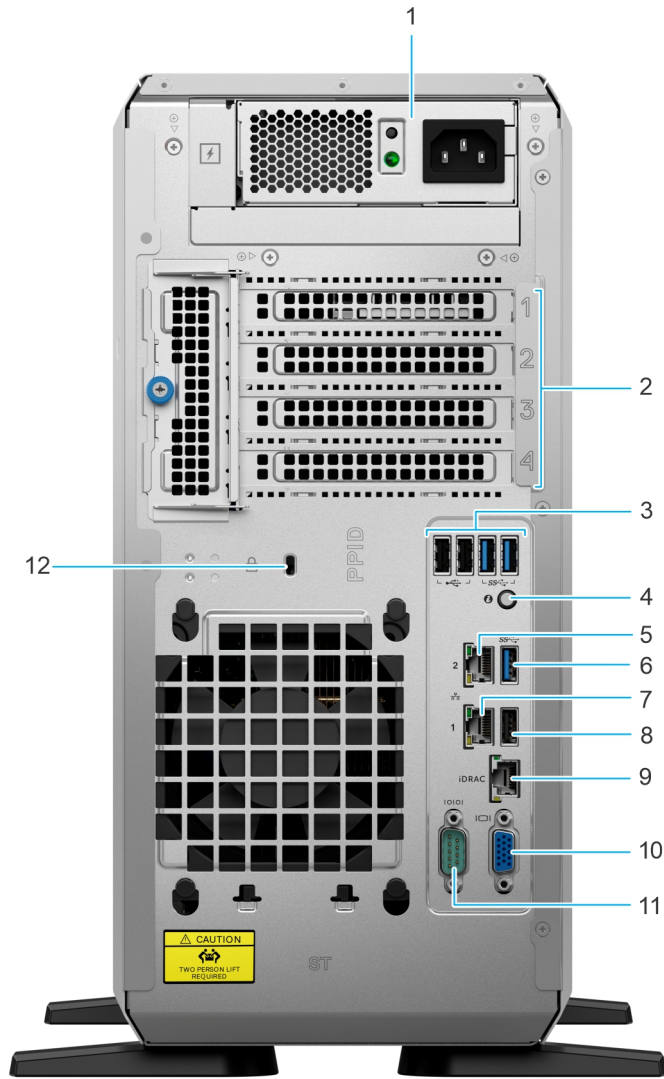







Figure 4. Rear view of the system with cable PSU

Table 4. Rear view of the system

Item	Ports, panels, or slots	Icon	Description
1	Cabled power supply unit		Enables you to connect to AC power source.
2	PCIe expansion card slots (4)	N/A	Enables you to connect PCI express expansion cards.
3	2 x USB 2.0 + 2 x USB 3.2 ports		Supports USB 2.0 and USB 3.2 compliant devices.
4	System Identification (ID) button		The System Identification (ID) button is available at the rear of the system. Press the button to identify a system by turning on the system ID button. You can also use the system ID button to reset iDRAC and to access BIOS using the step-through mode. When pressed, the system ID LED in the back panel blinks until either the front or rear

Table 4. Rear view of the system (continued)

Item	Ports, panels, or slots	Icon	Description
			button is pressed again. Press the button to toggle between on or off mode.
5	NIC port (2)		The NIC ports that are integrated on the LOM card provide network connectivity which is connected to the system board.
6	USB 3.2 port		Supports USB 3.2 compliant devices.
7	NIC port (1)		The NIC ports that are integrated on the LOM card provide network connectivity which is connected to the system board.
8	USB 2.0 port		Supports USB 2.0 compliant devices.
9	Dedicated iDRAC Ethernet port	iDRAC	Enables you to remotely access iDRAC. For more information, see the Integrated Dell Remote Access Controller User's Guide at PowerEdge Manuals .
10	VGA port		Enables you to connect a display device to the system.
11	Serial port		Enables you to connect a serial device to the system.
12	Kensington lock slot	N/A	Enables you to connect security cable to prevent unauthorized movement of your system.

Inside the system

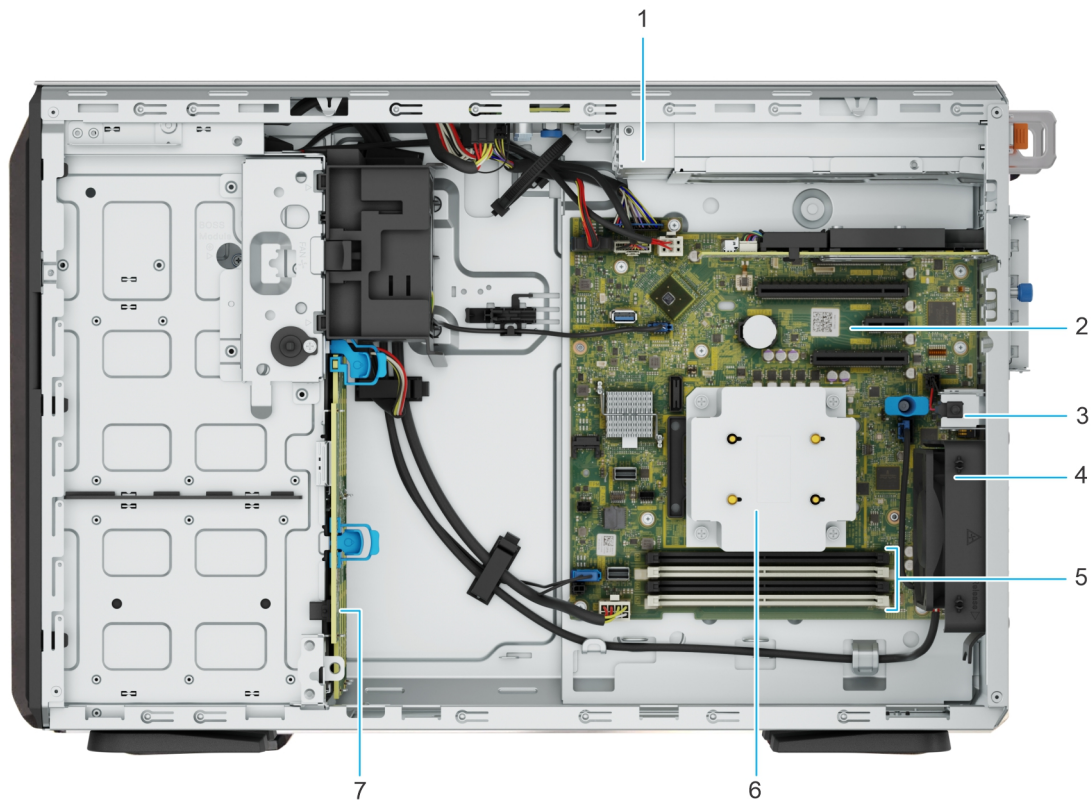

Figure 5. Inside view of the 8 x 3.5-inch configuration

- | | |
|--------------------------|-----------------|
| 1. PSU | 2. System board |
| 3. Intrusion switch | 4. Cooling fan |
| 5. Memory module sockets | 6. Heat sink |
| 7. Backplane | |

Locating the Express Service Code and Service Tag

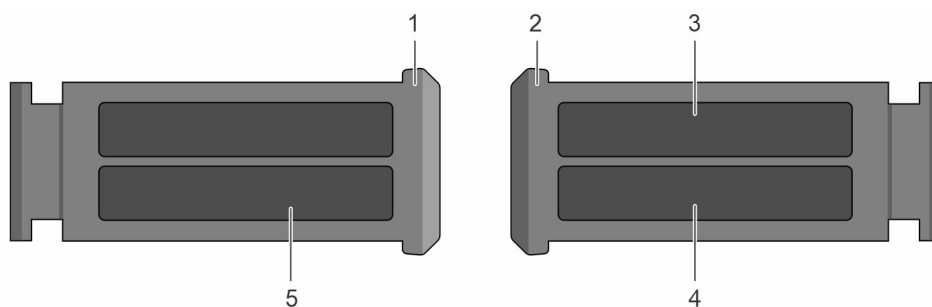

Figure 6. Locating the Express Service Code and Service tag

1. Express Service Tag (front view)
2. Express Service Tag (rear view)
3. OpenManage Mobile (OMM) label
4. iDRAC MAC address and iDRAC secure password label
5. Service Tag, Express Service Code, QRL label

System information labels

The system information label is located on the back side of the system cover.

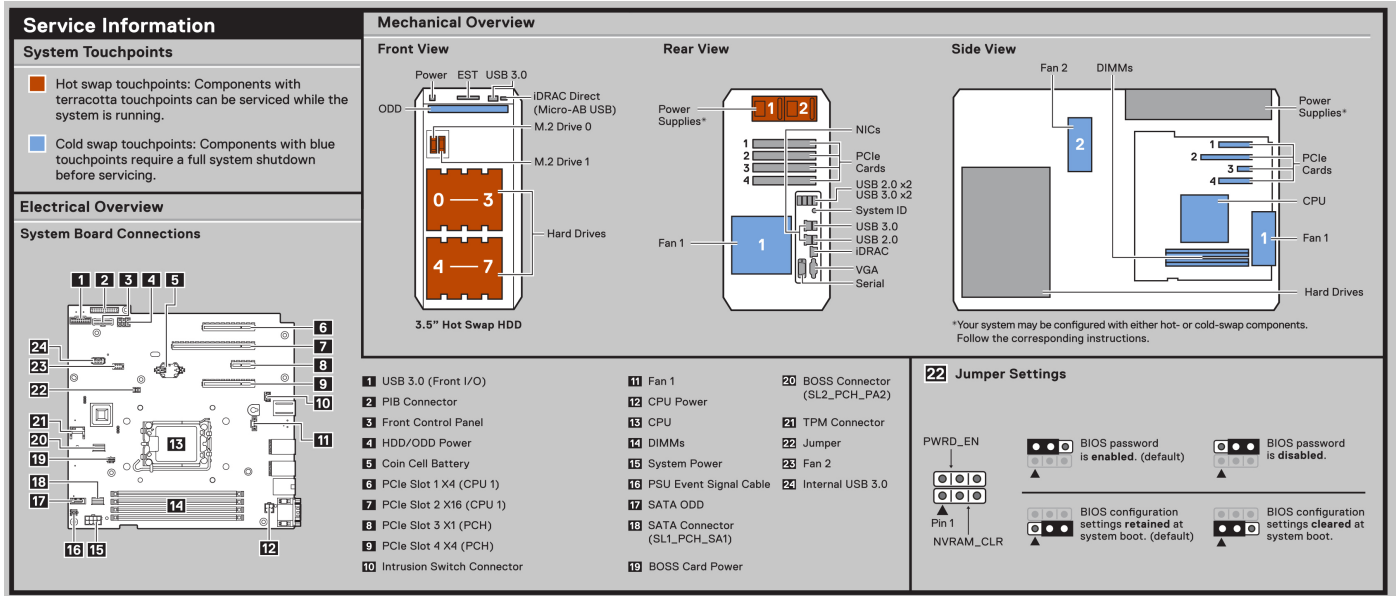

Figure 7. Service information

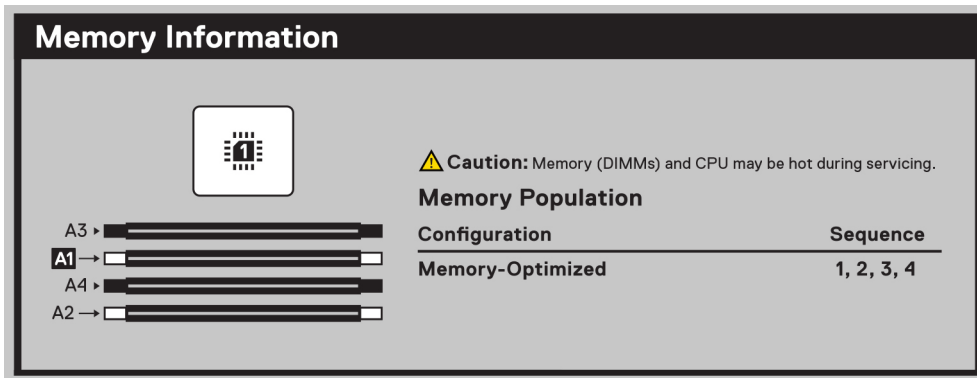

Figure 8. Memory information

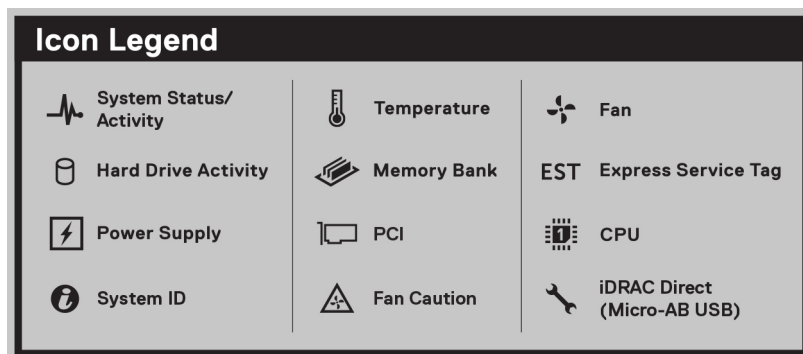

Figure 9. Icon legend

Technical specifications

The technical and environmental specifications of your system are outlined in this section.

Topics:

- Chassis dimensions
- System weight
- Processor specifications
- PSU specifications
- Cooling fan specifications
- Supported operating systems
- System battery specifications
- Expansion card riser specifications
- Memory specifications
- Storage controller specifications
- Drives
- Optical drives
- GPU specifications
- Ports and connectors specifications
- Video specifications
- Environmental specifications

Chassis dimensions

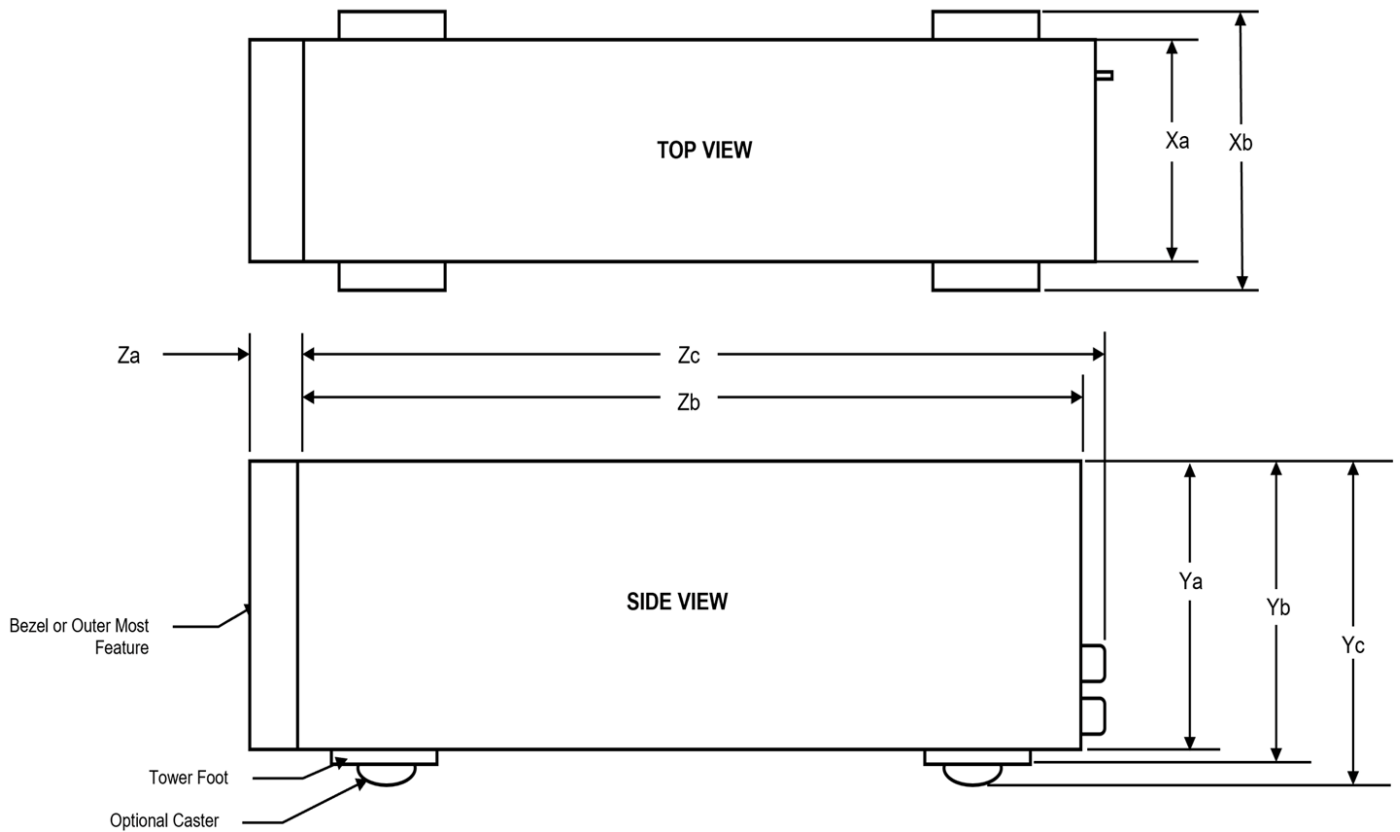

Figure 10. Chassis dimensions

Table 5. Chassis dimension for the system

Drives	Xa	Xb	Ya	Yb	Yc	Za (with bezel)	Za (without bezel)	Zb	Zc
8 x 3.5-inch SAS/SATA HDD/SSD	175.0 mm (6.89 inches)	N/A	369.5 mm (14.55 inches)	382.5 mm (15.06 inches)	N/A	19 mm (0.75 inches)	N/A	560.5 mm (22.07 inches)	562.12 mm (22.13 inches)

System weight

Table 6. PowerEdge T360 system weight

System configuration	Maximum weight (with all drives/SSDs)
A server with fully populated drives	25.10 kg (55.34 lbs)
A server without drives and PSU installed	18.29 kg (40.32 lbs)

Processor specifications

Table 7. PowerEdge T360 processor specifications

Supported processor	Number of processors supported
Intel Xeon E-2400 series processor	One

Table 7. PowerEdge T360 processor specifications (continued)

Supported processor	Number of processors supported
Intel Pentium G7400/ G7400T processor	One

PSU specifications

The PowerEdge T360 system supports up to two AC or DC power supply units (PSUs).

Table 8. PSU specifications

PSU	Class	Heat dissipation (maximum)	Frequency	AC Voltage			DC Voltage		Current
				100–120 V	200–240 V	277 V	240 V	336 V	
450 W	Platinum	1730 BTU/hr	50/60 Hz	450 W	450 W	N/A	N/A	N/A	6.5 A - 3.5 A
600 W Mixed Mode	Platinum	2250 BTU/hr	50/60 Hz	600 W	600 W	N/A	N/A	N/A	7.1 A - 3.6 A
	N/A	2250 BTU/hr	N/A	N/A	N/A	N/A	600 W	N/A	2.9 A
700 W Mixed Mode	Titanium	2625 BTU/hr	50/60 Hz	N/A	700 W	N/A	N/A	N/A	4.1 A
	N/A	2625 BTU/hr	N/A	N/A	N/A	N/A	700 W	N/A	3.4 A

- NOTE:** This system is also designed to connect to the IT power systems with a phase-to-phase voltage not exceeding 240 V.
- NOTE:** Heat dissipation is calculated using the PSU wattage rating.
- NOTE:** When selecting or upgrading the system configuration, to ensure optimum power utilization, verify the system power consumption with the Dell Energy Smart Solution Advisor available at Dell.com/ESSA.

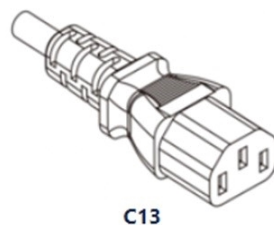

C13

Figure 11. PSU power cord

Table 9. PSU power cords

Form factor	Output	Power cord
Cable PSU 106 mm	450 W AC	C13/C14
Redundant 60 mm	600 W AC	C13/C14

Table 9. PSU power cords (continued)

Form factor	Output	Power cord
	700 W AC	C13/C14

Cooling fan specifications

The Dell PowerEdge T360 system supports up to one standard (STD) and one optional High Performance (HPR) cooling fan.

Table 10. Cooling fan specifications

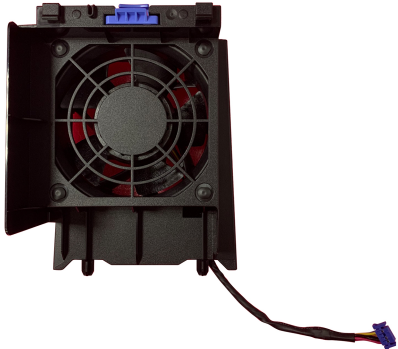
Fan type	Abbreviation	Also known as	Label color	Label image
Standard fan	STD	STD - Standard	N/A	
High Performance (HPR) fan	HPR	HPR - High Performance	N/A	

Supported operating systems

The PowerEdge T360 system supports the following operating systems:

- Canonical Ubuntu Server LTS
- Microsoft Windows Server with Hyper-V
- Red Hat Enterprise Linux
- SUSE Linux Enterprise Server
- VMware ESXi

For more information, go to [OS support](#).

System battery specifications

The PowerEdge T360 system uses one CR 2032 3.0-V lithium coin cell battery.

Expansion card riser specifications

The PowerEdge T360 system supports up to four PCIe slots (three Gen4 and one Gen5) on the system board.

Table 11. Expansion card slots supported on the system board

PCIe slot	Expansion card riser	Processor connection	Height	Length	Slot width
Slot 1 (Gen4)	N/A	Processor 1	Full Height	Half Length	x4
Slot 2 (Gen5)	N/A	Processor 1	Full Height	Half Length	x16
Slot 3 (Gen4)	N/A	Platform Controller Hub	Full Height	Half Length	x1
Slot 4 (Gen4)	N/A	Platform Controller Hub	Full Height	Half Length	x4

Memory specifications

The PowerEdge T360 system supports DDR5 UDIMM ECC memory in the following memory specifications for optimized operation.

Table 12. Memory specifications

DIMM type	DIMM rank	DIMM capacity	Single processor	
			Minimum system capacity	Maximum system capacity
DDR5 ECC UDIMM	Single rank	16 GB	16 GB	64 GB
	Dual rank	32 GB	32 GB	128 GB

Table 13. Memory module sockets

Memory module sockets	Speed
4, 288-pin	Up to 4400 MT/s

NOTE: Memory DIMM slots are not hot pluggable.

NOTE: The processor may reduce the performance of the rated DIMM speed. For more information, refer T360 Technical Guide at [PowerEdge Manuals](#).

Storage controller specifications

The PowerEdge T360 system supports the following controller cards:

Table 14. Storage controller cards

Supported storage controller cards
Internal controllers <ul style="list-style-type: none"> PERC H355 Adapter PERC H755 Adapter HBA355i Adapter
External controllers <ul style="list-style-type: none"> HBA355e Adapter

Table 14. Storage controller cards (continued)

Supported storage controller cards
Internal Boot <ul style="list-style-type: none">• Boot Optimized Storage Subsystem (BOSS-N1): HWRAID 2 x M.2 NVMe SSDs drives
Software RAID <ul style="list-style-type: none">• S160
SAS Host Bus Adapters (HBA) <ul style="list-style-type: none">• HBA355e Adapter

Drives

The PowerEdge T360 system supports:

- Up to 4 x 3.5-inch SATA HDD/SSD drives
- Up to 8 x 3.5-inch SAS/SATA HDD/SSD drives
- Up to 8 x 2.5-inch SAS/SATA HDD/SSD drives with 3.5-inch to 2.5-inch adapter

Optical drives

The PowerEdge T360 system supports one Slim SATA DVD-ROM drive or DVD +/- RW drive.

 **NOTE:** DVD devices support only data.

GPU specifications

The PowerEdge T360 system supports one 60 W single-width GPU.

 **NOTE:** Systems that are configured with GPUs have higher fan acoustics.

 **NOTE:** The T360 with GPU config is not recommended for an acoustic sensitive environment (table-top/floor standing office environment, or general use space etc.).

Ports and connectors specifications

NIC port specifications

The PowerEdge T360 system supports up to two 10/100/1000 Mbps Network Interface Controller (NIC) ports embedded on the LAN on Motherboard (LOM).

Table 15. NIC port specification for the system

Feature	Specifications
LOM on Planar	2 x 1 GbE
Network Card	1 GbE x 4, 10 GbE x 2, 10 GbE x 4

Serial connector specifications

The PowerEdge T360 system supports one serial port on the system board, which is Data Terminal Equipment (DTE), 16550-compliant .

The serial connector is installed as default on the system board.

Ports specifications

Table 16. PowerEdge T360 port specifications

Front		Rear		Internal	
Port type	No. of ports	Port type	No. of ports	Port type	No. of ports
USB 3.2 Gen1	One	USB 2.0	Three	USB 3.2 Gen1	One
iDRAC Direct (Micro-AB USB) port	One	USB 3.2 Gen1	Three		

 **NOTE:** The micro USB 2.0 compliant port can only be used as an iDRAC Direct or a management port.

Video specifications

The PowerEdge T360 system supports integrated Matrix G200eW graphics controller with 16 MB of video frame buffer.

Table 17. Supported video resolution options

Resolution	Refresh rate (Hz)	Color depth (bits)
640 x 480	60 Hz	32
640 x 480	72 Hz	32
640 x 480	75 Hz	32
640 x 480	85 Hz	32
800 x 600	60 Hz	32
800 x 600	72 Hz	32
800 x 600	75 Hz	32
800 x 600	85 Hz	32
1024 x 768	60 Hz	32
1024 x 768	72 Hz	32
1024 x 768	75 Hz	32
1024 x 768	85 Hz	32
1280 x 800	60 Hz	32
1280 x 800	75 Hz	32
1280 x 1024	60 Hz	32
1280 x 1024	75 Hz	32
1360 x 768	60 Hz	32
1440 x 900	60 Hz	32
1440 x 900	60 Hz (RB)	32
1600 x 900	60 Hz (RB)	32
1600 x 900	60 Hz (RB)	32
1600 x 1200	60 Hz	32
1600 x 1200	60 Hz (RB)	32
1680 x 1050	60 Hz (RB)	32

Table 17. Supported video resolution options (continued)

Resolution	Refresh rate (Hz)	Color depth (bits)
1680 x 1050	60 Hz	32
1920 x 1080	60 Hz	32
1920 x 1080	60 Hz (RB)	32
1920 x 1200	60 Hz	32
1920 x 1200	60 Hz (RB)	32

Environmental specifications

NOTE: For additional information about environmental certifications, refer to the *Product Environmental Datasheet* located with the *Documentation* on [support](#).

Table 18. Continuous Operation Specifications for ASHRAE A2

Temperature	Allowable continuous operations
Temperature range for altitudes <= 900 m (<= 2953 ft)	10–35°C (50–95°F) with no direct sunlight on the equipment
Humidity percent range (non-condensing at all times)	8% RH with -12°C minimum dew point to 80% RH with 21°C (69.8°F) maximum dew point
Operational altitude de-rating	Maximum temperature is reduced by 1°C/300 m (33.8°F/984 Ft) above 900 m (2953 Ft).

Table 19. Continuous Operation Specifications for ASHRAE A3

Temperature	Allowable continuous operations
Temperature range for altitudes <= 900 m (<= 2953 ft)	5–40°C (41–104°F) with no direct sunlight on the equipment
Humidity percent range (non-condensing at all times)	8% RH with -12°C minimum dew point to 85% RH with 24°C (75.2°F) maximum dew point
Operational altitude de-rating	Maximum temperature is reduced by 1°C/175 m (33.8°F/574 Ft) above 900 m (2953 Ft).

Table 20. Continuous Operation Specifications for ASHRAE A4

Temperature	Allowable continuous operations
Temperature range for altitudes <= 900 m (<= 2953 ft)	5–45°C (41–113°F) with no direct sunlight on the equipment
Humidity percent range (non-condensing at all times)	8% RH with -12°C minimum dew point to 90% RH with 24°C (75.2°F) maximum dew point
Operational altitude de-rating	Maximum temperature is reduced by 1°C/125 m (33.8°F/410 Ft) above 900 m (2953 Ft).

Table 21. Continuous Operation Specifications for Rugged Environment

Temperature	Allowable continuous operations
Temperature range for altitudes <= 900 m (<= 2953 ft)	5–55°C (41–131°F) with no direct sunlight on the equipment
Humidity percent range (non-condensing at all times)	8% RH with -12°C minimum dew point to 90% RH with 24°C (75.2°F) maximum dew point

Table 21. Continuous Operation Specifications for Rugged Environment (continued)

Temperature	Allowable continuous operations
Operational altitude de-rating	Maximum temperature is reduced by 1°C/125 m (33.8°F/410 Ft) above 900 m (2953 Ft).

Table 22. Common Environmental Specifications for ASHRAE A2, A3, A4, and Rugged

Allowable continuous operations	
Maximum temperature gradient (applies to both operation and non-operation).	20°C in an hour* (36°F in an hour) and 5°C in 15 minutes (41°F in 15 minutes), 5°C in an hour* (41°F in an hour) for tape <i>i</i> NOTE: * - Per ASHRAE thermal guidelines for tape hardware, these are not instantaneous rates of temperature change.
Non-operational temperature limits	-40 to 65°C (-40 to 149°F)
Non-operational humidity limits	5% to 95% RH with 27°C (80.6°F) maximum dew point
Maximum non-operational altitude	12,000 meters (39,370 ft)
Maximum operational altitude	3,048 meters (10,000 ft)

Table 23. Maximum vibration specifications

Maximum vibration	Specifications
Operating	0.26 G _{rms} at 5 Hz to 350 Hz (all operation orientations)
Storage	1.88 G _{rms} at 10 Hz to 500 Hz for 15 minutes (all six sides tested)

Table 24. Maximum shock pulse specifications

Maximum shock pulse	Specifications
Operating	Six consecutively executed shock pulses in the positive and negative x, y, and z axis of 6 G for up to 11 ms.
Storage	Six consecutively executed shock pulses in the positive and negative x, y, and z axis (one pulse on each side of the system) of 71 G for up to 2 ms.

Thermal restriction matrix

Table 25. Label reference

Label	Description
STD	Standard
HPR	High performance
HSK	Heat sink

Table 26. Thermal restriction matrix

-	TDP	Number of Cores	Configuration 1: 4x3.5-inch SATA	Configuration 2: 8x3.5-inch SAS/SATA
			HSK/FAN type	HSK/FAN type
CPU TDP	95 W	8	HPR/STD	HPR/STD
	95 W	6	HPR/STD	HPR/STD
	80 W	8	STD/STD	STD/STD
	80 W	6	STD/STD	STD/STD
	70 W	4	STD/STD	STD/STD

Table 26. Thermal restriction matrix (continued)

-	TDP	Number of Cores	Configuration 1: 4x3.5-inch SATA	Configuration 2: 8x3.5- inch SAS/SATA
			HSK/FAN type	HSK/FAN type
	65 W	8	STD/STD	STD/STD
	65 W	6	STD/STD	STD/STD
	55 W	4	STD/STD	STD/STD
	46 W	2	STD/STD	STD/STD
	35 W	2	STD/STD	STD/STD

NOTE: If BOSS or A2 GPU or a PCIe card >25 W and Broadcom 10 G NIC is installed, an HPR PCI fan and PCIe shroud are needed for both configurations.

Thermal air restrictions

ASHRAE A3/A4 environment

- The operating temperature is for a maximum altitude of 950 m for ASHRAE A3/A4 Cooling
- Redundant power supplies are required
- BOSS module is not supported
- Cooling redundancy is not supported due to single fan in the system (cooling zone is separated)
- A2 GPU is not supported
- Non-Dell qualified peripheral cards and /or peripheral cards greater than 25 W are not supported

Initial system setup and configuration

This section describes the tasks for initial setup and configuration of the Dell system. The section also provides general steps to set up the system and the reference guides for detailed information.

Topics:

- [Setting up the system](#)
- [iDRAC configuration](#)
- [Resources to install operating system](#)

Setting up the system

Perform the following steps to set up the system:

Steps

1. Unpack the system.
2. Connect the peripherals to the system and the system to the electrical outlet.
3. Power on the system.

For more information about setting up the system, see the *Getting Started Guide* that is shipped with your system.

i **NOTE:** For information about managing the basic settings and features of the system, see the [Pre-operating system management applications](#) chapter.

iDRAC configuration

The Integrated Dell Remote Access Controller (iDRAC) is designed to make you more productive as a system administrator and improve the overall availability of Dell servers. iDRAC alerts you to system issues, helps you to perform remote management, and reduces the need for physical access to the system.

Options to set up iDRAC IP address

To enable communication between your system and iDRAC, you must first configure the network settings based on your network infrastructure. The network settings option is set to **DHCP**, by default.

i **NOTE:** For static IP configuration, you must request for the settings at the time of purchase.

i **NOTE:** To access iDRAC, ensure that you connect the Ethernet cable to the iDRAC dedicated network port or use the iDRAC Direct port by using the micro USB (type AB) cable. You can also access iDRAC through the shared LOM mode, if you have opted for a system that has the shared LOM mode enabled.

Options to log in to iDRAC

To log in to the iDRAC Web User Interface, open a browser and enter the IP address.

You can log in to iDRAC as:

- iDRAC user
- Microsoft Active Directory user
- Lightweight Directory Access Protocol (LDAP) user

In the login screen displayed, if you have opted for secure default access to iDRAC, the default username is `root` and enter the iDRAC secure default password available on back of the Information Tag. If you opted for legacy password, use the iDRAC legacy username and password - `root` and `calvin`, the iDRAC default password will be blank on the information tag. Then you will be prompted and required to create a password of your choice before proceeding. You can also log in by using your Single Sign-On or Smart Card.

NOTE: Ensure that you change the default username and password after setting up the iDRAC IP address.

For more information about logging in to the iDRAC and iDRAC licenses, see the latest [Integrated Dell Remote Access Controller User's Guide](#)

NOTE: To determine the most recent iDRAC release for your platform and for latest documentation version, see KB article [KB78115](#).

You can also access iDRAC using command-line protocol - RACADM. For more information, see the [Integrated Dell Remote Access Controller RACADM CLI Guide](#) .

You can also access iDRAC using automation tool - Redfish API. For more information, see the [Integrated Dell Remote Access Controller User's Guide Redfish API Guide](#).

Resources to install operating system

If the system is shipped without an operating system, you can install a supported operating system by using one of the resources provided in the table below. For information about how to install the operating system, see the documentation links provided in the table below.

Table 27. Resources to install the operating system

Resource	Documentation links
iDRAC	Integrated Dell Remote Access Controller User's Guide or for system specific Integrated Dell Remote Access Controller User's Guide, go to PowerEdge Manuals > Product Support page of your system > Documentation . NOTE: To determine the most recent iDRAC release for your platform and for latest documentation version, see KB article at KB78115 .
Lifecycle Controller	Dell Lifecycle Controller User's Guide at iDRAC Manuals or for system specific Dell Lifecycle Controller User's Guide , go to PowerEdge Manuals > Product Support page of your system > Documentation . Dell recommends using Lifecycle Controller to install the OS, since all required drivers are installed on the system. NOTE: To determine the most recent iDRAC release for your platform and for latest documentation version, see KB article at KB78115 .
OpenManage Deployment Toolkit	OpenManage Manuals > OpenManage Deployment Toolkit
Dell certified VMware ESXi	Virtualization solutions

NOTE: For more information about installation and how-to videos for operating systems supported on PowerEdge systems, see [Supported Operating Systems for Dell PowerEdge systems](#).

Options to download drivers and firmware

You can download the firmware from the Dell support site. For information about downloading firmware, see the [Downloading drivers and firmware](#) section.

You can also choose any one of the following options to download the firmware. For information about how to download the firmware, see the documentation links provided in the table below.

Table 28. Options to download firmware

Option	Documentation link
Using Integrated Dell Remote Access Controller Lifecycle Controller (iDRAC with LC)	iDRAC Manuals
Using Dell Repository Manager (DRM)	OpenManage Manuals
Using Dell Server Update Utility (SUU)	OpenManage Manuals
Using Dell OpenManage Deployment Toolkit (DTK)	OpenManage Manuals
Using iDRAC virtual media	iDRAC Manuals

Options to download and install OS drivers

You can choose any one of the following options to download and install OS drivers. For information about how to download or install OS drivers, see the documentation links provided in the table below.

Table 29. Options to download and install OS drivers

Option	Documentation
Dell support site	Downloading drivers and firmware section.
iDRAC virtual media	Integrated Dell Remote Access Controller User's Guide or for system specific, go to Integrated Dell Remote Access Controller User's Guide > Product Support page of your system > Documentation . i NOTE: To determine the most recent iDRAC release for your platform and for latest documentation version, see Integrated Dell Remote Access Controller Release Notes .

Downloading drivers and firmware

It is recommended that you download and install the latest BIOS, drivers, and systems management firmware on the system.

Prerequisites

Ensure that you clear the web browser cache before downloading the drivers and firmware.

Steps

1. Go to [Drivers](#).
2. Enter the Service Tag of the system in the **Enter a Dell Service Tag, Dell Product ID or Model** field, and then press Enter.

i **NOTE:** If you do not have the Service Tag, click **Browse all products**, and navigate to your product.

3. On the displayed product page, click **Drivers & Downloads**.
On the **Drivers & Downloads** page, all drivers that are applicable to the system are displayed.
4. Download the drivers to a USB drive, CD, or DVD.

Pre-operating system management applications

You can manage basic settings and features of a system without booting to the operating system by using the system firmware.

Options to manage the pre-operating system applications

You can use any one of the following options to manage the pre-operating system applications:

- System Setup
- Dell Lifecycle Controller
- Boot Manager
- Preboot Execution Environment (PXE)

Topics:

- [System Setup](#)
- [Dell Lifecycle Controller](#)
- [Boot Manager](#)
- [PXE boot](#)

System Setup

Using the

System Setup option, you can configure the BIOS settings, iDRAC settings, and device settings of the system.

You can access system setup by using any one of the following interfaces:

- Graphical User interface — To access go to iDRAC Dashboard, click **Configurations > BIOS Settings**.
- Text browser — To enable the text browser, use the Console Redirection.

To view

System Setup, power on the system, press F2, and click **System Setup Main Menu**.

 **NOTE:** If the operating system begins to load before you press F2, wait for the system to finish booting, and then restart the system and try again.

The options on the

System Setup Main Menu screen are described in the following table:

Table 30. System Setup Main Menu

Option	Description
System BIOS	Enables you to configure the BIOS settings.
iDRAC Settings	Enables you to configure the iDRAC settings. The iDRAC settings utility is an interface to set up and configure the iDRAC parameters by using UEFI (Unified Extensible Firmware Interface). You can enable or disable various iDRAC parameters by using the iDRAC settings utility. For more information about this utility, see Integrated Dell Remote Access Controller User's Guide

Table 30. System Setup Main Menu (continued)

Option	Description
Device Settings	Enables you to configure device settings for devices such as storage controllers or network cards.
Service Tag Settings	Enables you to configure the System Service Tag.

System BIOS

To view the **System BIOS** screen, power on the system, press F2, and click **System Setup Main Menu > System BIOS**.

Table 31. System BIOS details

Option	Description
System Information	Provides information about the system such as the system model name, BIOS version, and Service Tag.
Memory Settings	Specifies information and options related to the installed memory.
Processor Settings	Specifies information and options related to the processor such as speed and cache size.
SATA Settings	Specifies options to enable or disable the embedded SATA controller and ports.
Boot Settings	Specifies options to specify the Boot mode (UEFI). Enables you to modify UEFI boot settings.
Network Settings	Specifies options to manage the UEFI network settings and boot protocols. Legacy network settings are managed from the Device Settings menu.  NOTE: Network Settings are not supported in BIOS boot mode.
Integrated Devices	Specifies options to manage integrated device controllers and ports, specifies related features, and options.
Serial Communication	Specifies options to manage the serial ports, its related features, and options.
System Profile Settings	Specifies options to change the processor power management settings, memory frequency.
System Security	Specifies options to configure the system security settings, such as system password, setup password, Trusted Platform Module (TPM) security, and UEFI secure boot. It also manages the power button on the system.
Redundant OS Control	Sets the redundant OS information for redundant OS control.
Miscellaneous Settings	Specifies options to change the system date and time.

System Information

To view the **System Information** screen, power on the system, press F2, and click **System Setup Main Menu > System BIOS > System Information**.

Table 32. System Information details

Option	Description
System Model Name	Specifies the system model name.
System BIOS Version	Specifies the BIOS version installed on the system.
System Management Engine Version	Specifies the current version of the Management Engine firmware.
System Service Tag	Specifies the system Service Tag.

Table 32. System Information details (continued)

Option	Description
System Manufacturer	Specifies the name of the system manufacturer.
System Manufacturer Contact Information	Specifies the contact information of the system manufacturer.
System CPLD Version	Specifies the current version of the system Complex Programmable Logic Device (CPLD) firmware.
UEFI Compliance Version	Specifies the UEFI compliance level of the system firmware.

Memory Settings

To view the **Memory Settings** screen, power on the system, press F2, and click **System Setup Main Menu > System BIOS > Memory Settings**.

Table 33. Memory Settings details

Option	Description
System Memory Size	Specifies the size of the system memory.
System Memory Type	Specifies the type of memory installed in the system.
System Memory Speed	Specifies the speed of the system memory.
Video Memory	Specifies the size video memory.
System Memory Testing	Specifies whether the system memory tests are run during system boot. The two options available are Enabled and Disabled . This option is set to Disabled by default.
Memory Operating Mode	This field selects the memory operating mode. This feature is active only if a valid memory configuration is detected. When Optimizer Mode is enabled, the DRAM controllers operate independently in 64-bit mode and provide optimized memory performance. When Dell Fault Resilient Mode (FRM) is enabled, a percentage of the total installed memory is configured to create a fault resilient zone starting from lowest system memory address for use by select hypervisors for host virtualization resilience. Specify the FRM percentage by using the Fault Resilient Mode Memory Size[%] feature. When Dell NUMA Fault Resilient Mode (FRM) is enabled, a percentage of the installed memory in every NUMA node is configured to create a fault resilient zone for use by select hypervisors for host virtualization resilience. Specify the FRM percentage by using the Fault Resilient Mode Memory Size[%] feature.
Current State of Memory Operating Mode	Specifies the current state of the memory operating mode.
Memory training	<p>When option is set to Fast and memory configuration is not changed, the system uses previously saved memory training parameters to train the memory subsystems and system boot time is also reduced. If memory configuration is changed, the system automatically enables Retrain at Next boot to force one-time full memory training steps, and then go back to Fast afterward.</p> <p>When option is set to Retrain at Next boot, the system performs the force one-time full memory training steps at next power on and boot time is slowed on next boot.</p> <p>When option is set to Enable, the system performs the force full memory training steps on every power on and boot time is slowed on every boot.</p>
DIMM Population	Provides information about the DIMM slots which has an installed DIMM.

Processor Settings

To view the **Processor Settings** screen, power on the system, press F2, and click **System Setup Main Menu > System BIOS > Processor Settings**.

Table 34. Processor Settings details

Option	Description
Logical Processor	Each processor core supports up to two logical processors. If this option is set to Enabled , the BIOS displays all the logical processors. If this option is set to Disabled , the BIOS displays only one logical processor per core. This option is set to Enabled by default.
Virtualization Technology	Enables or disables the virtualization technology for the processor. This option is set to Enabled by default.
Kernel DMA Protection	This option is set to Disabled by default. When the option is set to Enabled , BIOS and Operating System will enable direct memory access protection for DMA capable peripheral devices using virtualization technology.
Adjacent Cache Line Prefetch	Optimizes the system for applications that need high utilization of sequential memory access. This option is set to Enabled by default. You can disable this option for applications that need high utilization of random memory access.
Hardware Prefetcher	Enables or disables the hardware prefetcher. This option is set to Enabled by default.
LLC Prefetch	Enables or disables the LLC Prefetch on all threads. This option is set to Enabled by default.
Dead Line LLC Alloc	Enables or disables the Dead Line LLC Alloc. This option is set to Enabled by default. You can enable this option to enter the dead lines in LLC or disable the option to not enter the dead lines in LLC.
Directory AtoS	Enables or disables the Directory AtoS. AtoS optimization reduces remote read latencies for repeat read accesses without intervening writes. This option is set to Disabled by default.
x2APIC Mode	Enables or disables x2APIC mode. This option is set to Enabled by default. <i>i</i> NOTE: For two processors 64 core configuration, x2APIC mode is not switchable if 256 threads are enabled (BIOS settings: All CCD, cores, and logical processors enabled). <i>i</i> NOTE: x2APIC Mode has a dependency on Virtualization Technology. x2APIC Mode will take the setting assigned to Virtualization Technology and cannot be manually changed.
Number of Cores per Processor	This option is set to All by default.
Processor Core Speed	Specifies the maximum core frequency of the processor.

Table 35. Processor details

Option	Description
Family-Model-Stepping	Specifies the family, model, and stepping of the processor as defined by Intel.

Table 35. Processor details (continued)

Option	Description
Brand	Specifies the brand name.
Level 2 Cache	Specifies the total L2 cache.
Level 3 Cache	Specifies the total L3 cache.
Number of Cores	Specifies the number of cores per processor.
Microcode	Specifies the processor microcode version.

SATA Settings

To view the **SATA Settings** screen, power on the system, press F2, and click **System Setup Main Menu > System BIOS > SATA Settings**.

Table 36. SATA Settings details

Option	Description
Embedded SATA	Enables the embedded SATA option to be set to Off , AHCI mode , or RAID modes . This option is set to AHCI Mode by default. NOTE: <ol style="list-style-type: none"> You might also need to change the Boot Mode setting to UEFI. Otherwise, you should set the field to Non-RAID mode. No ESXi and Ubuntu OS support under RAID mode.
Security Freeze Lock	Sends Security Freeze Lock command to the embedded SATA drives during POST. This option is applicable only for AHCI Mode. This option is set to Enabled by default.
Write Cache	Enables or disables the command for the embedded SATA drives during POST. This option is applicable only for AHCI Mode. This option is set to Disabled by default.
Port n	Sets the drive type of the selected device. For AHCI Mode , BIOS support is always enabled.

Table 37. Port n

Options	Descriptions
Model	Specifies the drive model of the selected device.
Drive Type	Specifies the type of drive attached to the SATA port.
Capacity	Specifies the total capacity of the drive. This field is undefined for removable media devices such as optical drives.

Boot Settings

The **Boot Settings** only support **UEFI** mode.

- **UEFI:** The Unified Extensible Firmware Interface (UEFI) is a new interface between operating systems and platform firmware. The interface consists of data tables with platform related information, boot and runtime service calls that are available to the operating system and its loader. The following benefits are available when the **Boot Mode** is set to **UEFI**:
 - Support for drive partitions larger than 2 TB.
 - Enhanced security (e.g., UEFI Secure Boot).
 - Faster boot time.

NOTE: You must use only the UEFI boot mode in order to boot from NVMe drives.

To view the **Boot Settings** screen, power on the system, press F2, and click **System Setup Main Menu > System BIOS > Boot Settings**.

Table 38. Boot Settings details



Option	Description
Boot Mode	<p>Enables you to set the boot mode of the system. If the operating system supports UEFI, you can set this option to UEFI. Setting this field to BIOS allows compatibility with non-UEFI operating systems.</p> <p> CAUTION: Switching the boot mode may prevent the system from booting if the operating system is not installed in the same boot mode.</p> <p> NOTE: Setting this field to UEFI disables the BIOS Boot Settings menu.</p>
Boot Sequence Retry	<p>Enables or disables the Boot sequence retry feature or resets the system. When this option is set to Enabled and the system fails to boot, the system re-attempts the boot sequence after 30 seconds. When this option is set to Reset and the system fails to boot, the system reboots immediately. This option is set to Enabled by default.</p>
Generic USB Boot	<p>Enables or disables the generic USB boot placeholder. This option is set to Disabled by default.</p>
Hard-disk Drive Placeholder	<p>Enables or disables the Hard-disk drive placeholder. This option is set to Disabled by default.</p>
Clean all SysPrep variables and order	<p>When this option is set to None, BIOS will do nothing. When set to Yes, BIOS will delete variables of SysPrep #### and SysPrepOrder this option is a onetime option, will reset to none when deleting variables. This setting is only available in UEFI Boot Mode. This option is set to None by default.</p>
UEFI Boot Settings	<p>Specifies the UEFI boot sequence. Enables or disables UEFI Boot options.</p> <p> NOTE: This option controls the UEFI boot order. The first option in the list will be attempted first.</p>

Table 39. UEFI Boot Settings

Option	Description
UEFI Boot Sequence	Enables you to change the boot device order.
Boot Option Enable/Disable	Enables you to select the enabled or disabled boot devices

Choosing system boot mode

System Setup enables you to specify one of the following boot modes for installing your operating system:

- UEFI boot mode (the default), is an enhanced 64-bit boot interface. If you have configured your system to boot to UEFI mode, it replaces the system BIOS.
1. From the **System Setup Main Menu**, click **Boot Settings**, and select **Boot Mode**.
 2. Select the UEFI boot mode you want the system to boot into.

 **CAUTION: Switching the boot mode may prevent the system from booting if the operating system is not installed in the same boot mode.**

3. After the system boots in the specified boot mode, proceed to install your operating system from that mode.

 **NOTE:** Operating systems must be UEFI-compatible to be installed from the UEFI boot mode. DOS and 32-bit operating systems do not support UEFI and can only be installed from the BIOS boot mode.

 **NOTE:** For the latest information about supported operating systems, go to [OS support](#).

Changing boot order

About this task

You may have to change the boot order if you want to boot from a USB key.

Steps

1. On the **System Setup Main Menu** screen, click **System BIOS > Boot Settings > UEFI Boot Settings > UEFI Boot Sequence**.
2. Use the arrow keys to select a boot device, and use the plus (+) and minus (-) sign keys to move the device down or up in the order.
3. Click **Exit**, and then click **Yes** to save the settings on exit.

 **NOTE:** You can also enable or disable boot order devices as needed.

Network Settings

To view the **Network Settings** screen, power on the system, press F2, and click **System Setup Main Menu > System BIOS > Network Settings**.

 **NOTE:** Network Settings are not supported in BIOS boot mode.

Table 40. Network Settings details

Option	Description
UEFI PXE Settings	Enables you to control the configuration of the UEFI PXE device.
PXE Device n (n = 1 to 16)	Enables or disables the device. When enabled, a UEFI PXE boot option is created for the device.
PXE Device n Settings (n = 1 to 16)	Enables you to control the configuration of the PXE device.
UEFI HTTP Settings	Enables you to control the configuration of the UEFI HTTP device.
HTTP Device n (n = 1 to 4)	Enables or disables the device. When enabled, a UEFI HTTP boot option is created for the device.
HTTP Device n Settings (n = 1 to 4)	Enables you to control the configuration of the HTTP device.
UEFI ISCSI Settings	Enables you to control the configuration of the iSCSI device.

Table 41. PXE Device n Settings details

Option	Description
Interface	Specifies NIC interface used for the PXE device.
Protocol	Specifies Protocol used for PXE device. This option is set to IPv4 or IPv6 . This option is set to IPv4 by default.
VLAN	Enables Vlan for PXE device. This option is set to Enabled or Disabled . This option is set to Disabled by default.
VLAN ID	Shows the Vlan ID for the PXE device
VLAN Priority	Shows the Vlan Priority for the PXE device.

Table 42. HTTP Device n Settings details

Option	Description
Interface	Specifies NIC interface used for the HTTP device. This option is set to Embedded NIC 1 Port to select Embedded NIC1 interface, Embedded NIC 2 Port to select Embedded NIC2 interface.
Protocol	Specifies Protocol used for HTTP device. This option is set to IPv4 or IPv6 . This option is set to IPv4 by default.
VLAN	Enables Vlan for HTTP device. This option is set to Enable or Disable . This option is set to Disable by default.
VLAN ID	Shows the Vlan ID for the HTTP device
Vlan Priority	Shows the Vlan Priority for the HTTP device.

Table 42. HTTP Device n Settings details (continued)

Option	Description
DHCP	Enables or disables DHCP for this HTTP device. This option is set to Enabled by default.
IP Address	Specifies IP address for the HTTP device.
Subnet Mask	Specifies subnet mask for the HTTP device.
Autoconfiguration	Enables or disables the IPv6Autoconfiguration for the HTTP Device. When set to Enabled, IPv6 Address and Gateway are retrieved from the Autoconfiguration mechanism.
Prefix Length	IPv6 Prefix Length (0~127) for this HTTP Device.
IPv6 Address	IPv6 Unicast address for this HTTP Device.
Gateway	Specifies a gateway for the HTTP device.
DNS info via DHCP	Enables or disables DNS Information from DHCP. This option is set to Enabled by default.
Primary DNS	Specifies the primary DNS server IP address for the HTTP Device.
Secondary DNS	Specifies the secondary DNS server IP address for the HTTP Device.
URI (will obtain from DHCP server if not specified)	Obtain URI from the DHCP server if not specified.
TLS Authentication Configuration	Specifies the option for TLS authentication configuration. View or modify the device's boot TLS Authentication Mode. This option is set to One Way by default. None means the HTTP server and the client will not authenticate each other for this boot.
Root Certificate Configuration	Import, delete, or export the root certificate.

 **NOTE:** Autoconfiguration, Prefix Length and IPv6 Address options are visible only when **Protocol** is set to **IPv6**

Table 43. UEFI iSCSI Settings screen details

Option	Description
iSCSI Initiator Name	Specifies the name of the iSCSI initiator in IQN format.
iSCSI Device1	Enables or disables the iSCSI device. When disabled, a UEFI boot option is created for the iSCSI device automatically. This is set to Disabled by default.
iSCSI Device1 Settings	Enables you to control the configuration of the iSCSI device.

Table 44. iSCSI Device1 Settings screen details

Option	Description
Connection 1	Enables or disables the iSCSI connection. This option is set to Disabled by default.
Connection 2	Enables or disables the iSCSI connection. This option is set to Disabled by default.
Connection 1 Settings	Enables you to control the configuration for the iSCSI connection.
Connection 2 Settings	Enables you to control the configuration for the iSCSI connection.
Connection Order	Enables you to control the order for which the iSCSI connections will be attempted.

Integrated Devices

To view the **Integrated Devices** screen, power on the system, press F2, and click **System Setup Main Menu > System BIOS > Integrated Devices**.

Table 45. Integrated Devices details

Option	Description
User Accessible USB Ports	<p>Configures the user accessible USB ports. Selecting Only Back Ports On disables the front USB ports; selecting All Ports Off disables all front and back USB ports. This option is set to All Ports On by default.</p> <p>The USB keyboard and mouse still function in certain USB ports during the boot process, depending on the selection. After the boot process is complete, the USB ports will be enabled or disabled as per the setting.</p>
Internal USB Port	<p>Enables or disables the internal USB port. This option is set to ON by default.</p>
iDRAC Direct USB Port	<p>The iDRAC Direct USB port is managed by iDRAC exclusively with no host visibility. This option is set to ON or OFF. When set to OFF, iDRAC does not detect any USB devices installed in this managed port. This option is set to On by default.</p>
Embedded NIC1 and NIC2	<p>Enables or disables the OS interface of the Embedded NIC1 and NIC2 controller. If set to Disabled (OS), the NIC may still be available for shared network access by the embedded management controller. Configure the Embedded NIC1 and NIC2 option by using the NIC management utilities of the system. This option is set to Enabled by default.</p>
I/OAT DMA Engine	<p>Enables or disables the I/O Acceleration Technology (I/OAT) option. I/OAT is a set of DMA features designed to accelerate network traffic and lower CPU utilization. Enable only if the hardware and software support the feature. This option is set to Disabled by default.</p>
Embedded Video Controller	<p>Enables or disables the use of the Embedded Video Controller as the primary display. When set to Enabled, the Embedded Video Controller will be the primary display even if add-in graphic cards are installed. When set to Disabled, an add-in graphics card is used as the primary display. BIOS will output displays to both the primary add-in video and the embedded video during POST and preboot environment. The embedded video will then be disabled right before the operating system boots. This option is set to Enabled by default.</p> <p>NOTE: When there are multiple add-in graphic cards installed in the system, the first card discovered during PCI enumeration is selected as the primary video. You might have to rearrange the cards in the slots in order to control which card is the primary video.</p>
Current State of Embedded Video Controller	<p>Displays the current state of the embedded video controller. The Current State of Embedded Video Controller option is a read-only field. If the Embedded Video Controller is the only display capability in the system (that is, no add-in graphics card is installed), then the Embedded Video Controller is automatically used as the primary display even if the Embedded Video Controller setting is set to Disabled.</p>
OS Watchdog Timer	<p>If your system stops responding, this watchdog timer aids in the recovery of your operating system. When this option is set to Enabled, the operating system initializes the timer. When this option is set to Disabled (the default), the timer does not have any effect on the system.</p>
Empty Slot Unhide	<p>Enables or disables the root ports of all the empty slots that are accessible to the BIOS and operating system. This option is set to Disabled by default.</p>
Slot Disablement	<p>Enables or disables or boot driver disables the available PCIe slots on your system. The slot disablement feature controls the configuration of the PCIe cards installed in the specified slot. Slots must be disabled only when the installed peripheral card prevents booting into the operating system or causes delays in system startup. If the slot is disabled, both the Option ROM and UEFI drivers are disabled. Only slots that are present on the system will be available for control. When this option is set to boot driver disabled, both the Option ROM and UEFI driver from the slot will not run during POST. The system will not boot from the card and its pre-boot services will not be available. However, the card is available to the operating system.</p>

Table 45. Integrated Devices details (continued)

Option	Description
	Slot n: Enables or disables or only the boot driver is disabled for the PCIe slot n. This option is set to Enabled by default.

Serial Communication

To view the **Serial Communication** screen, power on the system, press F2, and click **System Setup Main Menu > System BIOS > Serial Communication**.

Table 46. Serial Communication details

Option	Description
Serial Communication	Enables the serial communication options. Selects serial communication devices (Serial Device 1 and Serial Device 2) in BIOS. BIOS console redirection can also be enabled, and the port address can be specified.
Serial Port Address	Enables you to set the port address for serial devices. This option is set to Serial Device1=COM2, Serial Device 2=COM1 and set to by default. <i>i</i> NOTE: You can use only Serial Device 2 for the Serial Over LAN (SOL) feature. To use console redirection by SOL, configure the same port address for console redirection and the serial device. <i>i</i> NOTE: Every time the system boots, the BIOS syncs the serial MUX setting that is saved in iDRAC. The serial MUX setting can independently be changed in iDRAC. Loading the BIOS default settings from within the BIOS setup utility may not always revert the serial MUX setting to the default setting of Serial Device 1.
External Serial Connector	Enables you to associate the External Serial Connector to Serial Device 1, Serial Device 2, or the Remote Access Device by using this option. This option is set to Serial Device 1 by default. <i>i</i> NOTE: Only Serial Device 2 can be used for Serial Over LAN (SOL). To use console redirection by SOL, configure the same port address for console redirection and the serial device. <i>i</i> NOTE: Every time the system boots, the BIOS syncs the serial MUX setting saved in iDRAC. The serial MUX setting can independently be changed in iDRAC. Loading the BIOS default settings from within the BIOS setup utility may not always revert this setting to the default setting of Serial Device 1.
Failsafe Baud Rate	Specifies the failsafe baud rate for console redirection. The BIOS attempts to determine the baud rate automatically. This failsafe baud rate is used only if the attempt fails, and the value must not be changed. This option is set to 115200 by default.
Remote Terminal Type	Sets the remote console terminal type. This option is set to VT100/VT220 by default.

System Profile Settings

To view the **System Profile Settings** screen, power on the system, press F2, and click **System Setup Main Menu > System BIOS > System Profile Settings**.

Table 47. System Profile Settings details

Option	Description
System Profile	Sets the system profile. If you set the System Profile option to a mode other than Custom , the BIOS automatically sets the rest of the options. You can only change the rest of the

Table 47. System Profile Settings details (continued)

Option	Description
	options if the mode is set to Custom . This option is set to Performance Per Watt (OS) by default. Other options include Performance and Custom . <i>i</i> NOTE: All the parameters on the system profile setting screen are available only when the System Profile option is set to Custom .
CPU Power Management	Sets the CPU power management. The options includes Maximum Performance and OS DBPM .
Memory Frequency	Sets the speed of the system memory. You can select Maximum Performance , Maximum Reliability or a specific speed. This option is set to Maximum Performance by default.
Turbo Boost	Enables or disables the processor to operate in the turbo boost mode. This option is set to Enabled by default.
C1E	Enables or disables the processor to switch to a minimum performance state when it is idle. This option is set to Enabled by default.
C-States	Enables or disables the processor to operate in all available power states. C States allow the processor to enter lower power states when idle. When set to Enabled (OS controlled) or when set to Autonomous (if hardware controlled is supported), the processor can operate in all available Power States to save power, but may increase memory latency and frequency jitter. This option is set to Enabled by default.
Memory Refresh Rate	Sets the memory refresh rate to either 1x or 2x. This option is set to 1x by default.
Uncore Frequency	Enables you to select the Uncore Frequency option. Dynamic mode enables the processor to optimize power resources across cores and uncores during runtime. Maximum mode enables the maximum uncore frequency.
Dynamic Load Line Switch	Dynamic Load Line Switch control. Dynamic Load Line (DLL) is a Power Management feature, which dynamically switches to the performance mode during periods of high CPU utilization. This setting is read-only and set to Enabled when Optimized Power Mode is Enabled. Read - Only unless System Profile is set to Custom.
Monitor/Mwait	Enables the Monitor/Mwait instructions in the processor. This option is set to Enabled for all system profiles, except Custom by default. <i>i</i> NOTE: This option can be disabled when System Profile is set to Custom . <i>i</i> NOTE: When C States is set to Enabled in the Custom mode, changing the Monitor/Mwait setting does not impact the system power or performance.
PCI ASPM L1 Link Power Management	Enables or disables the PCI ASPM L1 Link Power Management . This option is set to Enabled by default.
Workload Configuration	This feature allows you to select a preconfigured workload profile. This option is set to Balance by default.

System Security

To view the **System Security** screen, power on the system, press F2, and click **System Setup Main Menu > System BIOS > System Security**.

Table 48. System Security details

Option	Description
CPU AES-NI	Improves the speed of applications by performing encryption and decryption by using the Advanced Encryption Standard Instruction Set (AES-NI). This option is set to Enabled by default.
Strong Password Status	If enabled, you must set up a password that has at least one character in lowercase, uppercase, digit, and a special character. Also, you have the option to set the minimum number of characters in both the new passwords. If disabled, you can set a password

Table 48. System Security details (continued)

Option	Description
	that has any character in it but the passwords must not have more than 32 characters. Changes made by enabling or disabling this feature become immediately effective.
Strong Password Minimum Length (8 to 32)	Controls the minimum number of characters used when setting a system or setup password. You can specify 8-32 characters.
System Password	Sets the system password. This option is read-only if the password jumper is not installed in the system.
Setup Password	Sets the setup password. This option is read-only if the password jumper is not installed in the system.
Password Status	Locks the system password. This option is set to Unlocked by default.
TPM Information	Indicates the type of Trusted Platform Module, if present.

Table 49. TPM 2.0 security information

Option	Description
TPM Information	
TPM Security	 NOTE: The TPM menu is available only when the TPM module is installed. Enables you to control the reporting mode of the TPM. When set to Off, the presence of the TPM is not reported to the OS. When set to On, the presence of the TPM is reported to the OS. The TPM Security option is set to Off by default.
	When TPM 2.0 is installed, the TPM Security option is set to On or Off . This option is set to Off by default.
TPM Information	Indicates the type of Trusted Platform Module, if present.
TPM Firmware	Indicates the firmware version of the TPM.
TPM Hierarchy	Enables, disables, or clears the storage and endorsement hierarchies. When set to Enabled , the storage and endorsement hierarchies can be used.
	When set to Disabled , the storage and endorsement hierarchies cannot be used.
	When set to Clear , the storage and endorsement hierarchies are cleared of any values, and then reset to Enabled .
TPM Advanced Settings	TPM PPI Bypass Provision When set to Enabled , allows the Operating System to bypass Physical Presence Interface (PPI) prompts when issuing PPI Advanced Configuration and Power interface (ACPI) provisioning operations.
	TPM PPI Bypass Clear When set to Enabled allows the Operating System to bypass Physical Presence Interface (PPI) prompts when issuing PPI Advanced Configuration and Power Interface (ACPI) clear operations.
	TPM2 Algorithm Selection Allows the user to change the cryptographic algorithms used in the Trusted Platform Module (TPM). The available options are dependent on the TPM firmware. To enable TPM2 Algorithm Selection, Intel(R) TXT technology must be disabled. The TPM2 Algorithm Selection option supports SHA1, SHA128, SHA256, SHA512 and SM3 by detecting the TPM module. This option is set to SHA256 by default.

Table 50. System Security details

Option	Description
Intel(R) TXT	Enables you to set the Intel Trusted Execution Technology (TXT) option. To enable the Intel TXT option, virtualization technology and TPM Security must be enabled with Pre-boot measurements. This option is set to Off by default. It is set On for Secure Launch (Firmware Protection) support on Windows 2022.
Power button	Enables or disables the power button on the front of the system. This option is set to Enabled by default.
AC Power Recovery	Sets how the system behaves after AC power is restored to the system. This option is set to Last by default. <i>i</i> NOTE: The host system will not power on up until iDRAC Root of Trust (RoT) is completed, host power on will be delayed by minimum 90 seconds after the AC applied.
AC Power Recovery Delay	Sets the time delay for the system to power up after AC power is restored to the system. This option is set to Immediate by default. When this option is set to Immediate , there is no delay for power up. When this option is set to Random , the system creates a random delay for power up. When this option is set to User Defined , the system delay time is manually to power up.
User Defined Delay (120 s to 600 s)	Sets the User Defined Delay option when the User Defined option for AC Power Recovery Delay is selected. The actual AC recovery time needs to add iDRAC root of trust time (around 50 seconds).
UEFI Variable Access	Provides varying degrees of securing UEFI variables. When set to Standard (the default), UEFI variables are accessible in the operating system per the UEFI specification. When set to Controlled , selected UEFI variables are protected in the environment and new UEFI boot entries are forced to be at the end of the current boot order.
In-Band Manageability Interface	When set to Disabled , this setting hides the Management Engine's (ME), HECI devices, and the system's IPMI devices from the operating system. This prevents the operating system from changing the ME power capping settings, and blocks access to all in-band management tools. All management should be managed through out-of-band. This option is set to Enabled by default. <i>i</i> NOTE: BIOS update requires HECI devices to be operational and DUP updates require IPMI interface to be operational. This setting needs to be set to Enabled to avoid updating errors.
SMM Security Mitigation	Enables or disables the UEFI SMM security migration protections. It is set to Disabled by default.
Secure Boot	Enables Secure Boot, where the BIOS authenticates each pre-boot image by using the certificates in the Secure Boot Policy. Secure Boot is set to Disabled by default.
Secure Boot Policy	When the Secure Boot policy is set to Standard , the BIOS uses the system manufacturer's key and certificates to authenticate pre-boot images. When the Secure Boot policy is set to Custom , the BIOS uses the user-defined key and certificates. When set to Linux(R) Boot, VMware(R) Boot, or Microsoft(R) Boot , the Secure Boot policy includes only the certificates necessary for the corresponding operating system. The Secure Boot policy is set to Standard by default.
UEFI CA Certificate Scope	This setting controls how the Secure Boot feature uses the industry standard UEFI CA certificate in the Authorized Signature Database (db). For example, system administrators can configure this setting to use the UEFI CA certificate only for verifying boot device firmware (such as RAID controller firmware or NIC firmware) and not for verifying operating system loaders. This is useful in preventing attacks that exploit vulnerable operating system loaders that are signed by the UEFI CA certificate.
Secure Boot Mode	Configures how the BIOS uses the Secure Boot Policy Objects (PK, KEK, db, dbx). If the current mode is set to Deployed Mode , the available options are User Mode and Deployed Mode . If the current mode is set to User Mode , the available options are User Mode, Audit Mode, and Deployed Mode .

Table 50. System Security details (continued)

Option	Description
	<p>Below are the details of different boot modes available in the Secure Boot Mode option.</p> <p>User Mode In User Mode, PK must be installed, and BIOS performs signature verification on programmatic attempts to update policy objects. The BIOS allows unauthenticated programmatic transitions between modes.</p> <p>Audit mode In Audit Mode, PK is not present. BIOS does not authenticate programmatic update to the policy objects and transitions between modes. The BIOS performs a signature verification on pre-boot images and logs the results in the image Execution Information Table, but executes the images whether they pass or fail verification. Audit Mode is useful for programmatic determination of a working set of policy objects.</p> <p>Deployed Mode Deployed Mode is the most secure mode. In Deployed Mode, PK must be installed and the BIOS performs signature verification on programmatic attempts to update policy objects. Deployed Mode restricts the programmatic mode transitions.</p>
<p>Secure Boot Policy Summary</p>	<p>Specifies the list of certificates and hashes that secure boot uses to authenticate images. Below are the list of options available on the Secure Boot Policy Summary screen:</p> <ol style="list-style-type: none"> 1. Platform Key (PK) 2. Key Exchange Key (KEK) Database Entries 3. Authorized Signature Database (db) Entries <p>The options above are described through the following fields:</p> <ul style="list-style-type: none"> • Type • Issuer • Subject • Signature Owner GUID <ol style="list-style-type: none"> 4. Forbidden Signature Database (dbx) Entries
<p>Secure Boot Custom Policy Settings</p>	<p>Configures the Secure Boot Custom Policy. To enable this option, set the Secure Boot Policy to Custom option. Below are the list of options available on the Secure Boot Custom Policy Settings screen:</p> <ol style="list-style-type: none"> 1. Platform Key (PK) 2. Key Exchange Key (KEK) Database 3. Authorized Signature Database (db) 4. Forbidden Signature Database (dbx) 5. Delete All Policy Entries (PK, KEK, db, and dbx) 6. Restore Default Policy Entries (PK, KEK, db, and dbx) 7. Export Firmware Hash Values

Creating a system and setup password

Prerequisites

Ensure that the password jumper is enabled. The password jumper enables or disables the system password and setup password features. For more information, see the System board jumper settings section.

NOTE: If the password jumper setting is disabled, the existing system password and setup password are deleted and you need not provide the system password to boot the system.

Steps

1. To enter System Setup, press F2 immediately after turning on or rebooting your system.

2. On the **System Setup Main Menu** screen, click **System BIOS > System Security**.
3. On the **System Security** screen, verify that **Password Status** is set to **Unlocked**.
4. In the **System Password** field, type your system password, and press Enter or Tab.

Use the following guidelines to assign the system password:

- A password can have up to 32 characters.

A message prompts you to reenter the system password.

5. Reenter the system password, and click **OK**.
6. In the **Setup Password** field, type your setup password and press Enter or Tab. A message prompts you to reenter the setup password.
7. Reenter the setup password, and click **OK**.
8. Press Esc to return to the System BIOS screen. Press Esc again.

A message prompts you to save the changes.

 **NOTE:** Password protection does not take effect until the system reboots.

Using your system password to secure your system

About this task

If you have assigned a setup password, the system accepts your setup password as an alternate system password.

Steps

1. Turn on or reboot your system.
2. Type the system password and press Enter.

Next steps

When **Password Status** is set to **Locked**, type the system password and press Enter when prompted at reboot.

 **NOTE:** If an incorrect system password is typed, the system displays a message and prompts you to reenter your password. You have three attempts to type the correct password. After the third unsuccessful attempt, the system displays an error message that the system has stopped functioning and must be turned off. Even after you turn off and restart the system, the error message is displayed until the correct password is entered.

Deleting or changing system and setup password

Prerequisites

 **NOTE:** You cannot delete or change an existing system or setup password if the **Password Status** is set to **Locked**.

Steps

1. To enter System Setup, press F2 immediately after turning on or restarting your system.
2. On the **System Setup Main Menu** screen, click **System BIOS > System Security**.
3. On the **System Security** screen, ensure that **Password Status** is set to **Unlocked**.
4. In the **System Password** field, alter or delete the existing system password, and then press Enter or Tab.
5. In the **Setup Password** field, alter or delete the existing setup password, and then press Enter or Tab. If you change the system and setup password, a message prompts you to reenter the new password. If you delete the system and setup password, a message prompts you to confirm the deletion.
6. Press Esc to return to the **System BIOS** screen. Press Esc again, and a message prompts you to save the changes.
7. Select **Setup Password**, change, or delete the existing setup password and press Enter or Tab.

 **NOTE:** If you change the system password or setup password, a message prompts you to reenter the new password. If you delete the system password or setup password, a message prompts you to confirm the deletion.

Operating with setup password enabled

If **Setup Password** is set to **Enabled**, type the correct setup password before modifying the system setup options.

If you do not type the correct password in three attempts, the system displays the following message:

```
Invalid Password! Number of unsuccessful password attempts: <x> System Halted! Must power down.
```

Even after you power off and restart the system, the error message is displayed until the correct password is typed. The following options are exceptions:

- If **System Password** is not set to **Enabled** and is not locked through the **Password Status** option, you can assign a system password. For more information, see the System Security Settings screen section.
- You cannot disable or change an existing system password.

NOTE: You can use the password status option with the setup password option to protect the system password from unauthorized changes.

Redundant OS Control

To view the **Redundant OS Control** screen, power on the system, press F2, and click **System Setup Main Menu > System BIOS > Redundant OS Control**.

Table 51. Redundant OS Control details

Option	Description
Redundant OS Location	Enables you to select a backup disk from the following devices: <ul style="list-style-type: none"> • None • BOSS PCIe Cards (Internal M.2 Drives) • SATA Port A
Redundant OS State	<p>NOTE: This option is disabled if Redundant OS Location is set to None.</p> <p>When set to Visible, the backup disk is visible to the boot list and OS. When set to Hidden, the backup disk is disabled and is not visible to the boot list and OS. This option is set to Visible by default.</p> <p>NOTE: BIOS disables the device in hardware, so it is not accessed by the OS.</p>
Redundant OS Boot	<p>NOTE: This option is disabled if Redundant OS Location is set to None or if Redundant OS State is set to Hidden.</p> <p>When set to Enabled, BIOS boots to the device specified in Redundant OS Location. When set to Disabled, BIOS preserves the current boot list settings. This option is set to Disabled by default.</p>

Miscellaneous Settings

To view the **Miscellaneous Settings** screen, power on the system, press F2, and click **System Setup Main Menu > System BIOS > Miscellaneous Settings**.

Table 52. Miscellaneous Settings details

Option	Description
System Time	Enables you to set the time on the system.
System Date	Enables you to set the date on the system.
Time Zone	Enables you to select required Time Zone.
Daylight Savings Time	Enables or disables Daylight Savings Time. This option is set to Disabled by default.

Table 52. Miscellaneous Settings details (continued)

Option	Description
Asset Tag	Specifies the asset tag and enables you to modify it for security and tracking purposes.
Keyboard NumLock	Enables you to set whether the system boots with the NumLock enabled or disabled. This option is set to On by default.  NOTE: This option does not apply to 84-key keyboards.
F1/F2 Prompt on Error	Enables or disables the F1/F2 prompt on error. This option is set to Enabled by default. The F1/F2 prompt also includes keyboard errors.
Dell Wyse P25/P45 BIOS Access	Enables or disables the Dell Wyse P25/P45 BIOS Access. This option is set to Enabled by default.
Power Cycle Request	Enables or disables the Power Cycle Request. This option is set to None by default.

iDRAC Settings

The iDRAC settings is an interface to set up and configure the iDRAC parameters by using UEFI. You can enable or disable various iDRAC parameters by using the iDRAC settings.

 **NOTE:** Accessing some of the features on the iDRAC settings needs the iDRAC Enterprise License upgrade.

For more information about using iDRAC, see *Dell Integrated Dell Remote Access Controller User's Guide* at [iDRAC Manuals](#).

Device Settings

Device Settings enables you to configure device parameters such as storage controllers or network cards.

Service Tag Settings

Service Tag Settings enables you to configure the System Service Tag.

Dell Lifecycle Controller

Dell Lifecycle Controller (LC) provides advanced embedded systems management capabilities including system deployment, configuration, update, maintenance, and diagnosis. LC is delivered as part of the iDRAC out-of-band solution and Dell system embedded Unified Extensible Firmware Interface (UEFI) applications.

Embedded system management

The Dell Lifecycle Controller provides advanced embedded system management throughout the lifecycle of the system. The Dell Lifecycle Controller is started during the boot sequence and functions independently of the operating system.

 **NOTE:** Certain platform configurations may not support the full set of features provided by the Dell Lifecycle Controller.

For more information about setting up the Dell Lifecycle Controller, configuring hardware and firmware, and deploying the operating system, see the Dell Lifecycle Controller documentation at [iDRAC Manuals](#).

Boot Manager

The **Boot Manager** option enables you to select boot options and diagnostic utilities.

To enter **Boot Manager**, power on the system and press F11.

Table 53. Boot Manager details

Option	Description
Continue Normal Boot	The system attempts to boot to devices starting with the first item in the boot order. If the boot attempt fails, the system continues with the next item in the boot order until the boot is successful or no more boot options are found.
One-shot UEFI Boot Menu	Allows you to select a UEFI boot option for a one-time boot. The option selected does not modify the boot order settings.
Launch System Setup	Enables you to access System Setup.
Launch Lifecycle Controller	Exits the Boot Manager and invokes the Dell Lifecycle Controller program.
System Utilities	Enables you to launch System Utilities menu such as Launch Diagnostics, BIOS update File Explorer, Reboot System.

PXE boot

You can use the Preboot Execution Environment (PXE) option to boot and configure the networked systems remotely.

To access the **PXE boot** option, boot the system and then press F12 during POST instead of using standard Boot Sequence from BIOS Setup. It does not pull any menu or allows managing of network devices.

Minimum to POST

This section describes the minimum to POST system requirement of the Dell system.

Topics:

- [Minimum configuration to POST](#)
- [Configuration validation](#)

Minimum configuration to POST

The components listed below are the minimum configuration to POST:

- Processor
- One memory module (DIMM) in slot A1
- One power supply unit in PSU1
- Power Interposer Board (PIB)
- System board + Front I/O module

Configuration validation

The new generation of Dell systems have added interconnect flexibility and advanced iDRAC management features to collect precise system configuration information and report configuration errors.

When the system is powered on, information about installed cables, risers, backplanes, power supplies, floating card (fPERC, adapter PERC , BOSS), and processor is obtained from the CPLD and backplane memory maps are analyzed. This information forms a unique configuration, which is compared with one of the qualified configurations that are stored in a table that is maintained by iDRAC.

One or more sensors are assigned to each of the configuration elements. During POST, any configuration validation error is logged in the System Event Log (SEL)/LifeCycle (LC) log. The reported events are categorized in the configuration validation error table.

Table 54. Configuration validation error

Error	Description	Possible cause and recommendations	Example
Config Error	A configuration element within the closest match contains something that is unexpected and does not match any Dell qualified configuration.	Wrong configuration	Config Error: Backplane cable CTRS_SRC_SA1 and BP-DST_SA1
		The element reported in HWC8010 errors are assembled incorrectly. Verify element (cable, risers, etc) placement in the system.	Config Error : SL Cable PLANAR_SL7 and CTRL_DST_PA1
Config Missing	iDRAC found a configuration element missing within the closest match detected.	Missing or damaged cable, device, or part	Config Missing: Float card front PERC/HBAadapter PERC/HBA
		Missing element or cable is reported in HWC8010 error logs. Install the missing element (cable, risers, etc).	Config Missing : SL cable PLANAR_SL8 and CTRL_DST_PA1

Table 54. Configuration validation error (continued)

Error	Description	Possible cause and recommendations	Example
Comm Error	A configuration element is not responding to iDRAC using the management interface while running an inventory check.	System management sideband communication Unplug AC Power, reset the element and replace the element if the problem persists.	Comm Error: Backplane 2

Error messages

This section describes the error messages that are displayed on the screen during POST or captured in the system event log (SEL)/LifeCycle (LC) log.

Table 55. Error message HWC8010

Error code	HWC8010
Message	The System Configuration Check operation that is resulted in the following issue involving the indicated component type
Arguments	Riser, floating card (fPERC, adapter PERC, BOSS), backplane, processor, cable, or other components
Detailed Description	The issue that is identified in the message is observed in the System Configuration Check operation.
Recommended Response Action	Do the following and retry the operation: <ol style="list-style-type: none"> 1. Disconnect the input power. 2. Check for proper cable connection and component placement. If the issue persists, contact the service provider.
Category	System Health (HWC = Hardware Config)
Severity	Critical
Trap/EventID	2329

Table 56. Error message HWC8011

Error code	HWC8011
Message	The System Configuration Check operation that is resulted in multiple issues involving the indicated component type
Arguments	Riser, floating card (fPERC, adapter PERC, BOSS), backplane, processor, cable, or other components
Detailed Description	Multiple issues are observed in the System Configuration Check operation.
Recommended Response Action	Do the following and retry the operation: <ol style="list-style-type: none"> 1. Disconnect the input power. 2. Check for proper cable connection and component placement. If the issue persists, contact the service provider.
Category	System Health (HWC = Hardware Config)
Severity	Critical

Installing and removing system components

Topics:

- Safety instructions
- Before working inside your system
- After working inside your system
- Recommended tools
- Optional front bezel
- System feet
- System cover
- Air shroud
- PCIe air shroud
- Intrusion switch
- Drives
- Optional optical drive
- Drive backplane
- Cooling fans
- Cable routing
- System memory
- Processor and heat sink
- Expansion cards and expansion card risers
- Optional BOSS-N1 module
- Power supply unit
- Power interposer board
- System battery
- System board
- Trusted Platform Module
- Control panel

Safety instructions

Before working inside your system

Prerequisites

Follow the safety guidelines listed in the [Safety instructions](#).

Steps

1. Power off the system and all attached peripherals.
2. Disconnect the system from the electrical outlet and disconnect the peripherals.
3. Remove the system cover.

After working inside your system

Prerequisites

Follow the safety guidelines listed in [Safety instructions](#).

Steps

1. Replace the system cover.
2. Reconnect the peripherals and connect the system to the electrical outlet, and then power on the system.

Recommended tools

You may need some or all of the following tools to perform the removal and installation procedures:

- Key to the bezel lock. The key is required only if your system includes a bezel.
- Phillips 1 screwdriver
- Phillips 2 screwdriver
- Torx T15 screwdriver
- 5 mm hex nut screwdriver
- Plastic scribe
- 1/4-inch flat blade screwdriver
- Wrist grounding strap connected to the ground
- ESD mat
- Needle-nose pliers

Optional front bezel

Removing the front bezel

Prerequisites

1. Follow the safety guidelines listed in the [Safety instructions](#).
2. Keep the bezel key handy.

 **NOTE:** The bezel key is part of the security bezel package.

Steps

1. Unlock the bezel.
2. Pull from the top end of the bezel to disengage it from the system.
3. Unhook the bezel tabs from the slots at the bottom of the system to remove the bezel from the system.



Figure 12. Removing the front bezel

Next steps

Installing the front bezel.

Installing the front bezel

Prerequisites

1. Follow the safety guidelines listed in the [Safety instructions](#).
2. Locate and remove the bezel key.

i **NOTE:** The bezel key is part of the security bezel package.

Steps

1. Align and insert the tabs on the bezel into the slots on the system.
2. Push the bezel toward the system until it locks into place.
3. Lock the bezel.



Figure 13. Installing the front bezel

System feet

Removing the system feet

Prerequisites

1. Follow the safety guidelines listed in [Safety instructions](#).
2. Place the system on its side on a flat, stable surface.
3. Rotate the system feet inward.

Steps

1. Using the Phillips 2 screwdriver, remove the screw that secures the foot to the base of the system.
2. Repeat the preceding step to remove the remaining system feet.

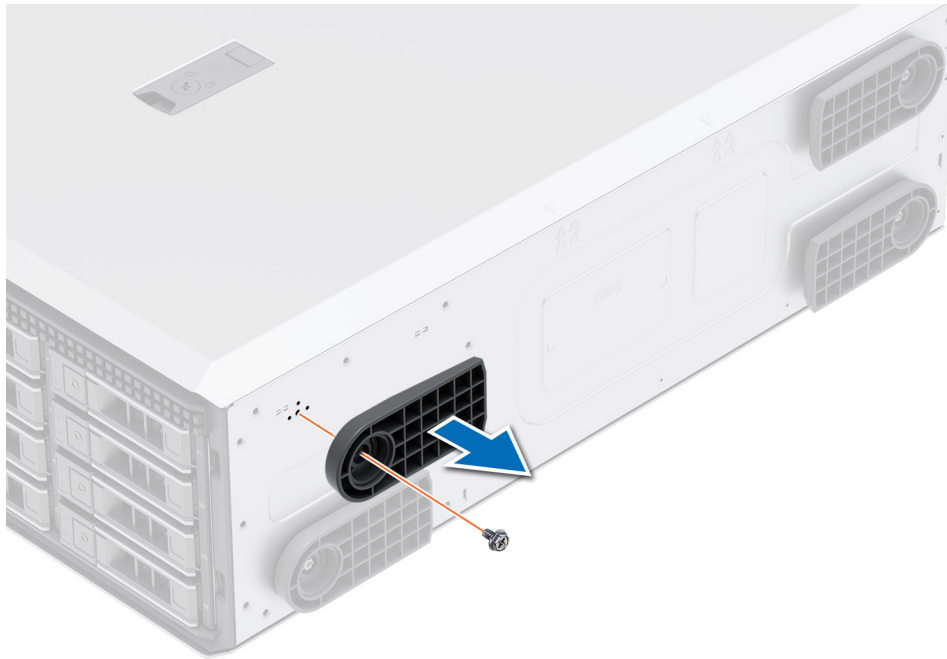

Figure 14. Removing the system feet

Next steps

[Installing the system feet.](#)

Installing the system feet

Prerequisites

CAUTION: Install the feet on a stand-alone tower system to provide stability to the system. An unstable system might tip over and cause injury to the user or damage to the system.

1. Follow the safety guidelines listed in [Safety instructions](#).
2. Place the system on its side, on a flat, stable surface.

Steps

1. Align the three tabs on the system foot with the three slots on the base of the system.
2. Using the Phillips 2 screwdriver, tighten the screw that secures the foot to the base of the system.
3. Repeat the preceding step to install the remaining system feet.

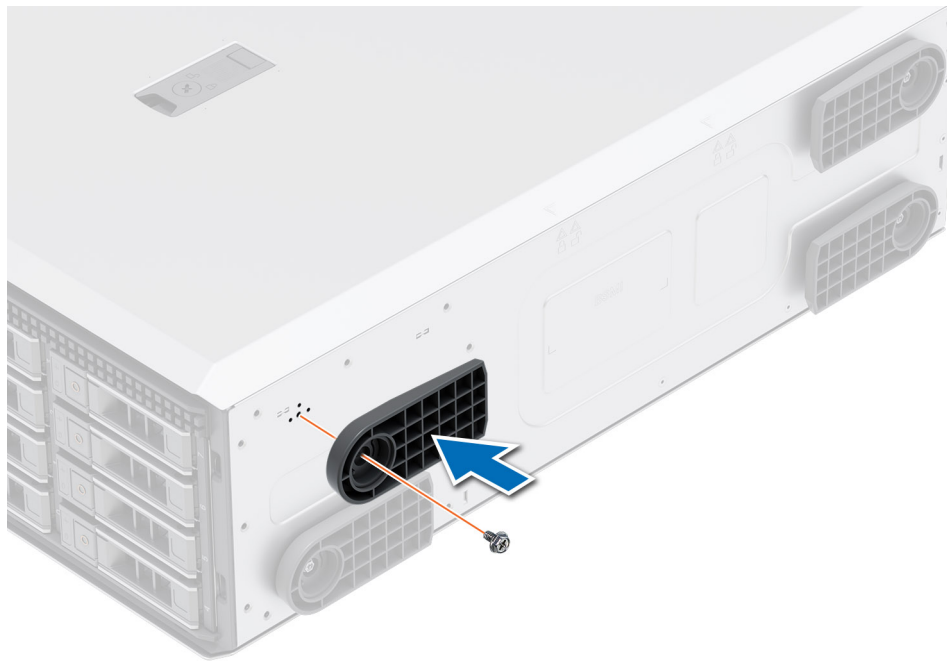

Figure 15. Installing the system feet

Next steps

1. Place the system upright on a flat, stable surface, and rotate the system feet outward.
2. Follow the procedure listed in [After working inside your system](#).

System cover

Removing the system cover

Prerequisites

1. Follow the safety guidelines listed in [Safety instructions](#).
2. Power off the system, and any attached peripherals.
3. Disconnect the system from the electrical outlet and peripherals.
4. If installed, [remove the front bezel](#).

Steps

1. Use a 1/4-inch flat head or a Phillips 2 screwdriver to turn the cover release latch lock counterclockwise to the unlock position.
2. Lift the release latch until the system cover slides back.
3. Lift the cover from the system.



Figure 16. Removing the system cover

Next steps

Replace the system cover.

Installing the system cover

Prerequisites

1. Follow the safety guidelines listed in [Safety instructions](#).
2. Follow the procedure listed in [Before working inside your system](#).

NOTE: Ensure that all internal cables are connected and routed properly, and that there are no tools or extra parts that are left inside the system.

Steps

1. Align the tabs on the system cover with the guide slots on the system and slide the system cover.
2. Close the system cover release latch.

NOTE: Ensure that the system cover closes without obstruction or unnecessary force. Reseat any cables or components or realign the system cover if necessary.

3. Using a 1/4-inch flat head or Phillips 2 screwdriver, rotate the lock clockwise to the lock position.



Figure 17. Installing the system cover

Next steps

1. If removed, [install the front bezel](#).
2. Reconnect the peripherals and connect the system to the electrical outlet.
3. Power on the system, including all attached peripherals.

Air shroud

Removing the air shroud

Prerequisites

CAUTION: Never operate your system with the air shroud removed. The system may get overheated quickly, resulting in shutdown of the system and loss of data.

1. Follow the safety guidelines listed in [Safety instructions](#).
2. Follow the procedure listed in [Before working inside your system](#).

Steps

Hold the edges of the air shroud, and lift the air shroud out of the system.

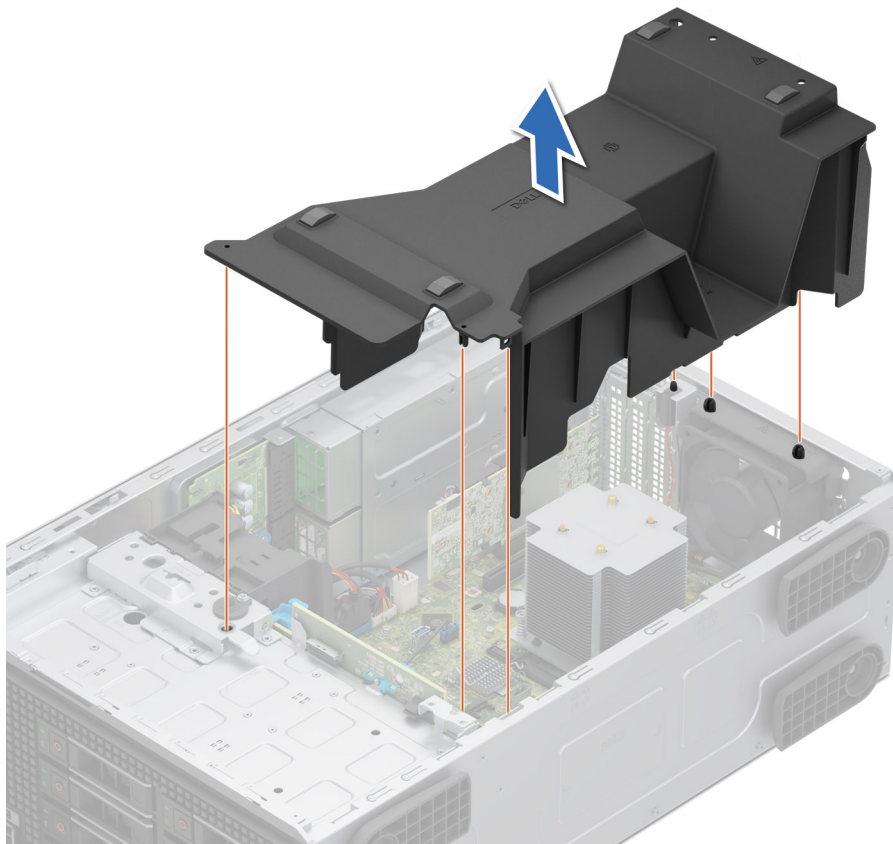

Figure 18. Removing the air shroud

Next steps

Replace the air shroud.

Installing the air shroud

Prerequisites

1. Follow the safety guidelines listed in [Safety instructions](#).
2. Follow the procedure listed in [Before working inside your system](#).
3. If applicable, route the cables inside the system along the chassis wall and secure the cables by using the cable-securing bracket.

Steps

1. Align the tabs on the air shroud with the guide pins on the system.
2. Lower the air shroud into the system, until firmly seated.

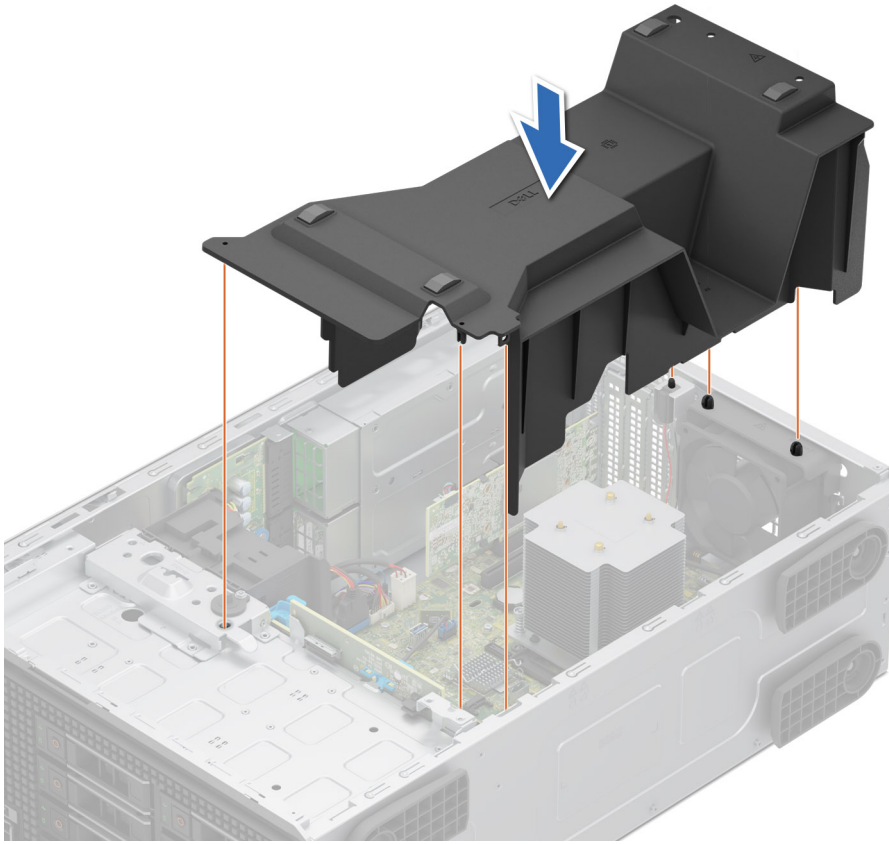

Figure 19. Installing the air shroud

Next steps

Follow the procedure listed in [After working inside your system.](#)

PCIe air shroud

Removing the PCIe air shroud

Prerequisites

CAUTION: Never operate your system with the air shroud removed. The system may get overheated quickly, resulting in shutdown of the system and loss of data.

NOTE: PCIe air shroud is required when BOSS N1 or A2 GPU is installed.

1. Follow the safety guidelines listed in [Safety instructions](#).
2. Follow the procedure listed in [Before working inside your system](#).

Steps

Hold the edges of the PCIe air shroud, and lift the air shroud out of the system.

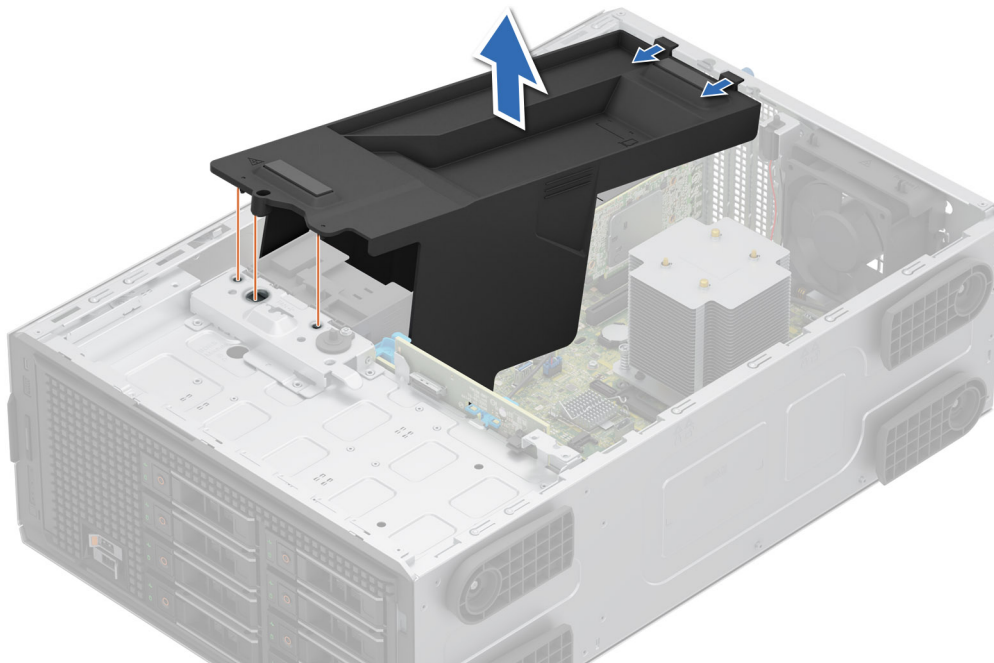

Figure 20. Removing the PCIe air shroud

Next steps

Replace the air shroud.

Installing the PCIe air shroud

Prerequisites

1. Follow the safety guidelines listed in [Safety instructions](#).
2. Follow the procedure listed in [Before working inside your system](#).
3. If applicable, route the cables inside the system along the chassis wall and secure the cables by using the cable-securing bracket.

Steps

1. Align the tabs on the PCIe air shroud with the guide pins on the system.
2. Lower the PCIe air shroud into the system, until firmly seated.

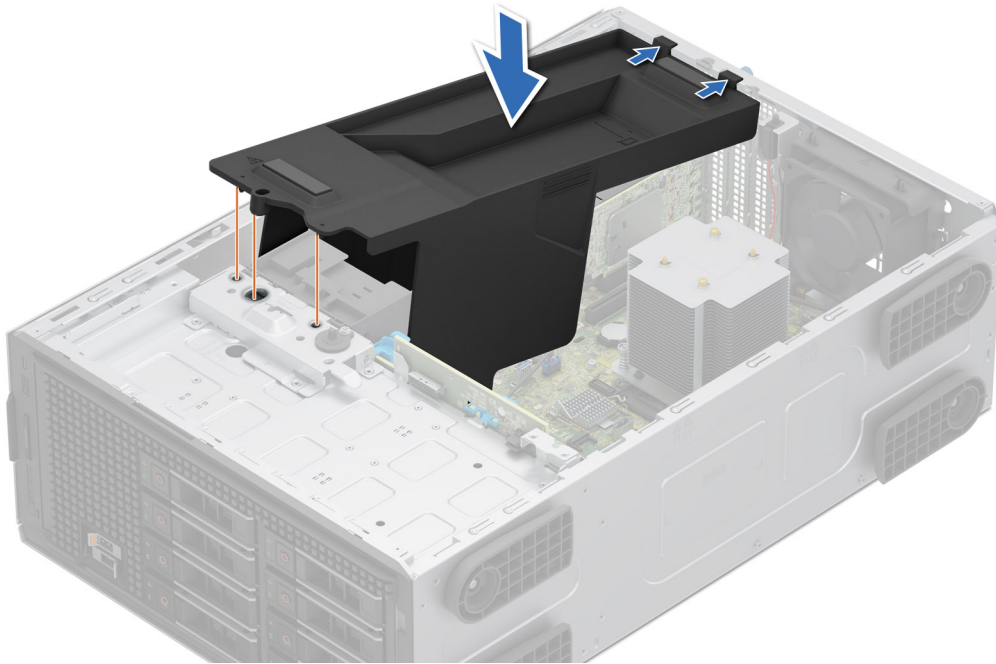

Figure 21. Installing the PCIe air shroud

Next steps

Follow the procedure listed in [After working inside your system](#).

Intrusion switch

This is a service technician replaceable part only.

Removing the intrusion switch module

Prerequisites

1. Follow the safety guidelines listed in [Safety instructions](#).
2. Follow the procedure listed in [Before working inside your system](#).
3. [Remove the air shroud](#).

Steps

1. Disconnect the intrusion switch cable from the connector on the system board.

NOTE: Observe the routing of the cable as you remove it from the system. Route the cable properly when you replace it to prevent the cable from being pinched or crimped.

2. Slide the intrusion switch module out of the system slot.

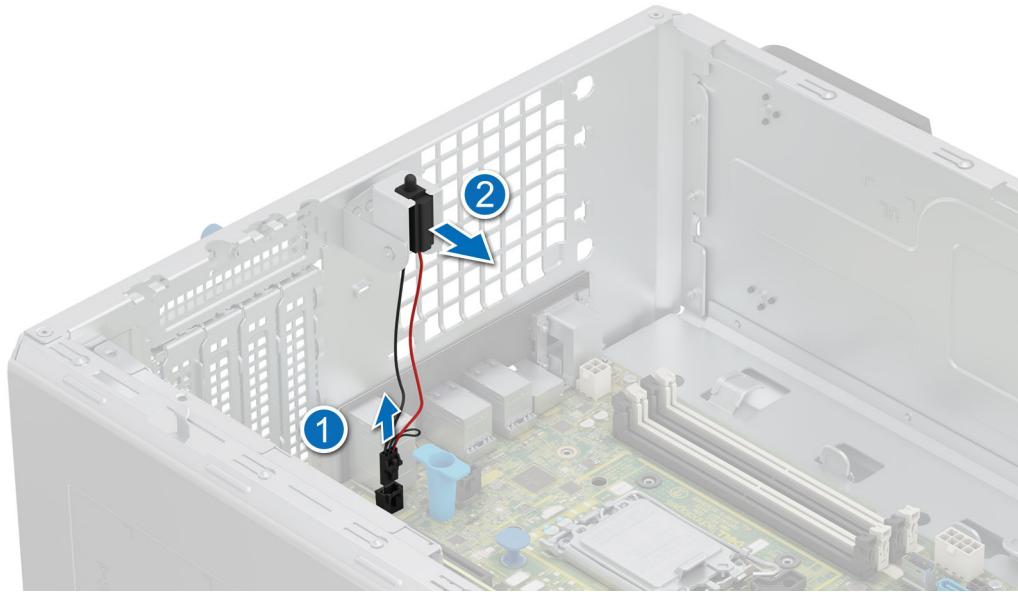

Figure 22. Removing the intrusion switch module

Next steps

Replace the intrusion switch module.

Installing the intrusion switch module

Prerequisites

1. Follow the safety guidelines listed in [Safety instructions](#).
2. Follow the procedure listed in [Before working inside your system](#).

Steps

1. Align and slide the intrusion switch module into the system slot until firmly seated.
2. Connect the intrusion switch cable to the connector on the system board.

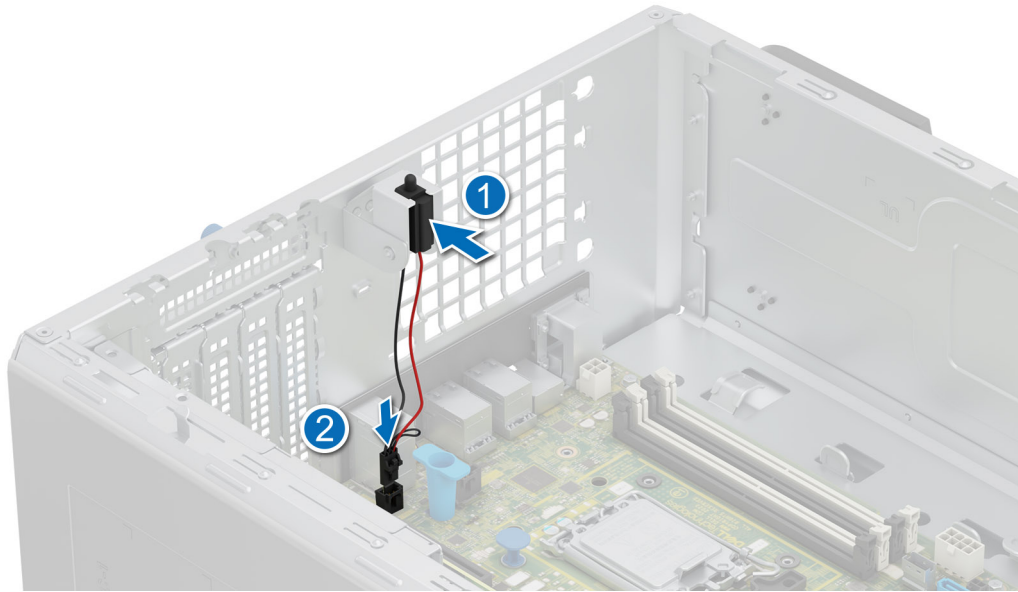

Figure 23. Installing the intrusion switch module

Next steps

1. [Install the air shroud.](#)
2. Follow the procedure that is listed in [After working inside your system.](#)

Drives

Removing a drive blank

Prerequisites

1. Follow the safety guidelines listed in [Safety instructions.](#)
2. Follow the procedure listed in [Before working inside your system.](#)
3. [Remove the front bezel.](#)

⚠ CAUTION: To maintain proper system cooling, drive blanks must be installed in all empty drive slots.

⚠ CAUTION: Mixing drive blanks from previous generations of PowerEdge servers is not supported.

Steps

Press the release button, and slide the drive blank out of the drive slot.

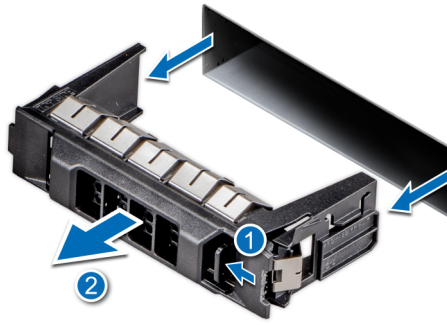

Figure 24. Removing a drive blank

Next steps

1. Install the drive or replace the drive blank.

Installing a drive blank

Prerequisites

1. Follow the safety guidelines listed in [Safety instructions](#).
2. Follow the procedure in [Before working inside your system](#).
3. [Remove the front bezel](#).

CAUTION: To maintain proper system cooling, drive blanks must be installed in all empty drive slots.

CAUTION: Mixing drive blanks from previous generations of PowerEdge servers is not supported.

Steps

Slide the drive blank into the drive slot until the release button clicks into place.

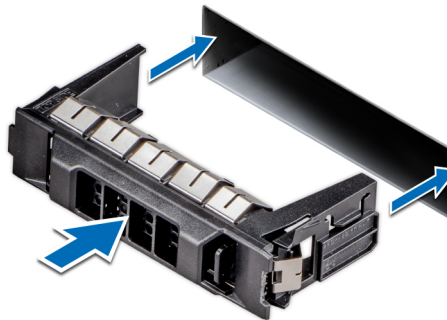

Figure 25. Installing a drive blank

Next steps

1. [Replace the front bezel](#).
2. Follow the procedure listed in [After working inside your system](#).

Removing a drive carrier

Prerequisites

1. Follow the safety guidelines listed in [Safety instructions](#).

2. Remove the front bezel.
3. Using the management software, prepare the drive for removal. If the drive is online, the green activity or fault indicator flashes while the drive is turning off. When the drive indicators are off, the drive is ready for removal. For more information, see the storage controller documentation.

CAUTION: Before attempting to remove or install a drive while the system is running, see the documentation for the storage controller card to ensure that the host adapter is configured correctly to support drive removal and insertion.

CAUTION: To prevent data loss, ensure that your operating system supports drive installation. See the documentation supplied with your operating system.

Steps

1. Press the release button to open the drive carrier release handle.
 2. Holding the drive carrier release handle, slide the drive carrier out of the drive slot.
- NOTE:** If you are not replacing the drive immediately, install a drive blank in the empty drive slot to maintain proper system cooling.

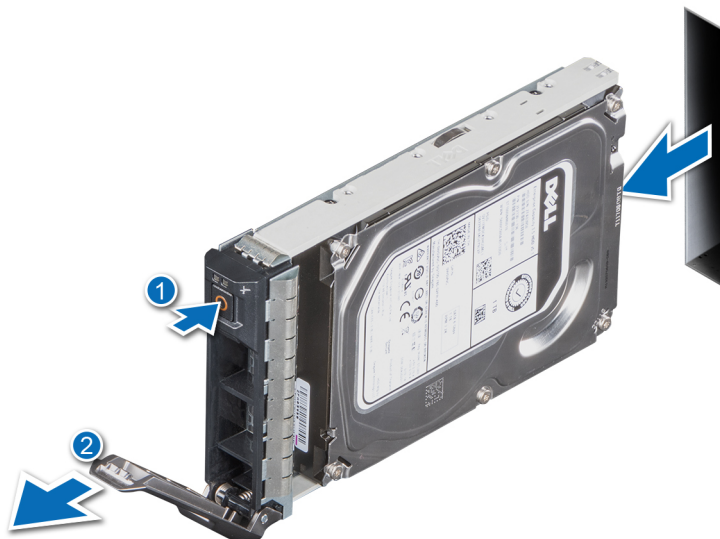

Figure 26. Removing a drive carrier

Next steps

Replace the drive or a drive blank.

Installing the drive carrier

Prerequisites

CAUTION: Before removing or installing a drive while the system is running, see the documentation for the storage controller card to ensure that the host adapter is configured correctly to support drive removal and insertion.

CAUTION: Combining SAS and SATA drives in the same RAID volume is not supported.

CAUTION: When installing a drive, ensure that the adjacent drives are fully installed. Inserting a drive carrier and attempting to lock its handle next to a partially installed carrier can damage the partially installed carrier's shield spring and make it unusable.

NOTE: Ensure that the drive carrier's release handle is in the open position before inserting the carrier into the slot.

CAUTION: To prevent data loss, ensure that your operating system supports hot-swap drive installation. See the documentation supplied with your operating system.

CAUTION: When a replacement hot swappable drive is installed and the system is powered on, the drive automatically begins to rebuild. Ensure that the replacement drive is blank or contains data that you wish to overwrite. Any data on the replacement drive is immediately lost after the drive is installed.

1. Follow the safety guidelines listed in [Safety instructions](#).
2. [Remove the front bezel](#).
3. Remove the drive carrier or remove the drive blank when you want to assemble the drives in to the system.

Steps

1. Slide the drive carrier into the drive slot and push until the drive connects with the backplane.
2. Close the drive carrier release handle to lock the drive in place.



Figure 27. Installing a drive carrier

Next steps

Install the front bezel.

Removing the drive from the drive carrier

Prerequisites

1. Follow the safety guidelines listed in [Safety instructions](#).
2. [Remove the front bezel](#).
3. [Remove the drive carrier](#).

Steps

1. Using a Phillips 1 screwdriver, remove the screws from the slide rails on the drive carrier.

NOTE: If the hard drive or SSD carrier has Torx screw, use Torx 6 (for 2.5-inch drive) or Torx 8 (for 3.5-inch drive) screw driver to remove the drive.



2. Lift the drive out of the drive carrier.



Figure 28. Removing the drive from the drive carrier

Next steps

1. [Replace the drive into the drive carrier.](#)

Installing the drive into the drive carrier

Prerequisites

1. Follow the safety guidelines listed in [Safety instructions](#).
2. [Remove the front bezel.](#)
3. [Remove the drive carrier.](#)

Steps

1. Insert the drive into the drive carrier with the connector end of the drive towards the rear of the carrier.
2. Align the screw holes on the drive with the screws holes on the drive carrier.
3. Using a Phillips 1 screwdriver, secure the drive to the drive carrier with the screws.

NOTE: If the hard drive or SSD carrier has Torx screw, use Torx 6 (for 2.5-inch drive) or Torx 8 (for 3.5-inch drive) screwdriver to install the drive.





Figure 29. Installing a drive into the drive carrier

Next steps

1. [Install the drive carrier.](#)
2. [Install the front bezel.](#)

Removing a 3.5-inch drive adapter from a 3.5-inch drive carrier

Prerequisites

1. Follow the safety guidelines listed in [Safety instructions](#).
2. [Remove the drive carrier.](#)

Steps

1. Remove the screws from the rails on the drive carrier.

(i) NOTE: If the 3.5-inch drive has Torx screw, use Torx 6 screwdriver to remove the drive from a 3.5-inch drive adapter.



2. Lift the 3.5-inch drive adapter out of the drive carrier.

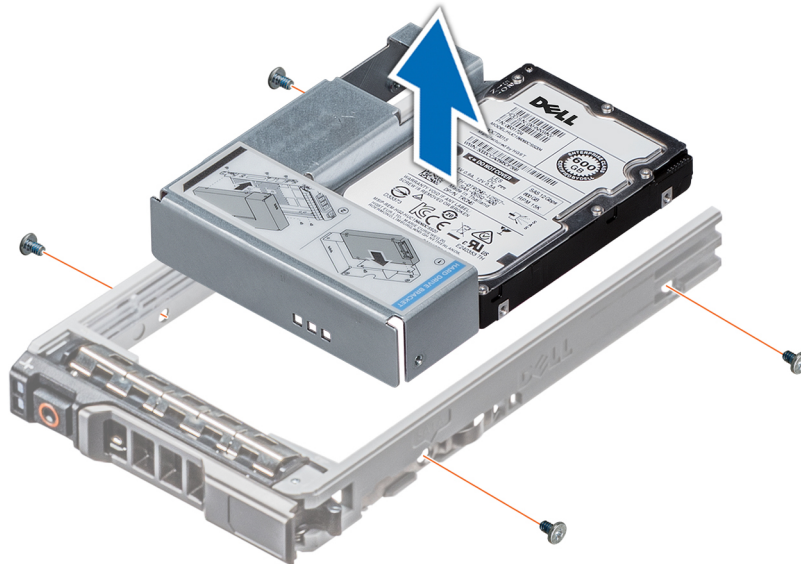

Figure 30. Removing a 3.5-inch drive adapter from a 3.5-inch drive carrier

Next steps

Replace a 3.5-inch adapter into a 3.5-inch drive carrier.

Installing a 3.5-inch adapter into a 3.5-inch drive carrier

Prerequisites

1. Follow the safety guidelines listed in [Safety instructions](#).
2. [Remove the drive carrier](#).

Steps

1. Insert the 3.5 inch drive adapter into the drive carrier with the connector end of the drive toward the rear of the drive carrier.
2. Align the screw holes on the drive and drive adapter with the holes on the drive carrier.
3. Install the screws to secure the drive to the drive carrier.

 **NOTE:** If the 3.5-inch drive has Torx screw, use Torx 6 screwdriver to install the drive to a 3.5-inch drive adapter.



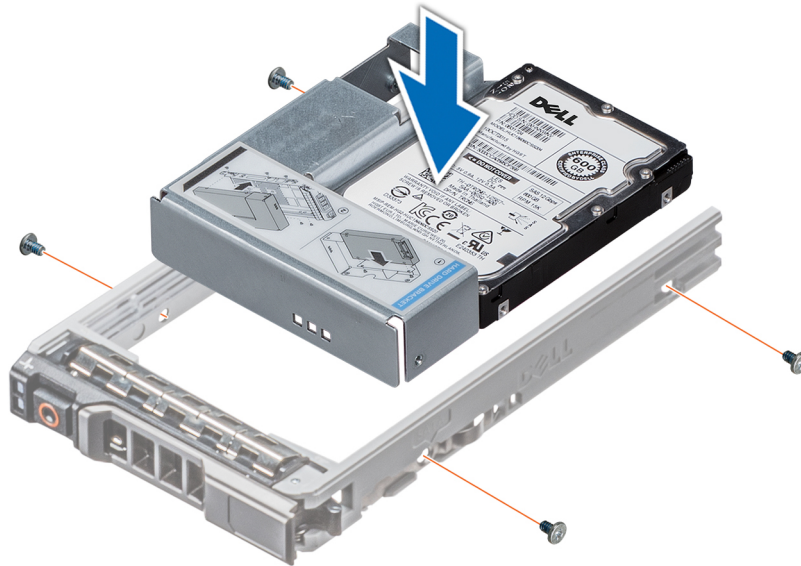

Figure 31. Installing a 3.5-inch drive adapter into the 3.5-inch drive carrier

Next steps

1. [Install the drive carrier.](#)

Removing a 2.5-inch drive from the 3.5-inch drive adapter

Prerequisites

1. Follow the safety guidelines listed in [Safety instructions](#).
2. [Remove the drive carrier.](#)
3. [Remove 3.5-inch drive adapter from the 3.5-inch drive carrier.](#)

i **NOTE:** A 2.5-inch hot swappable drive is installed in a 3.5-inch drive adapter, which is then installed in the 3.5-inch hot swappable drive carrier.

Steps

1. Using a Phillips 1 screwdriver, remove the screws that secures the drive to the 3.5-inch drive adapter.

i **NOTE:** If the 2.5-inch drive has Torx screw, use Torx 6 screwdriver to remove the drive from a 3.5-inch drive adapter.



2. Remove the drive from the 3.5-inch drive adapter.

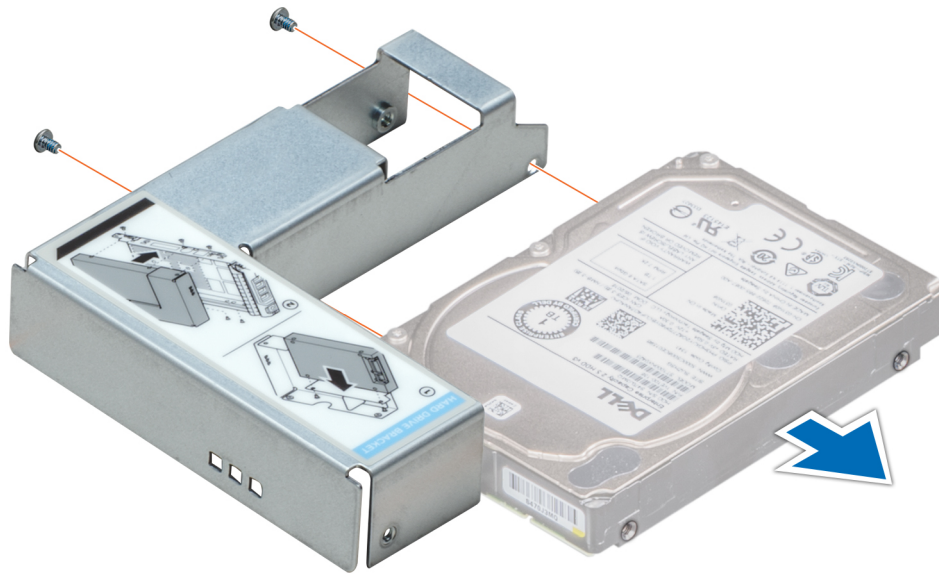

Figure 32. Removing a 2.5-inch drive from the 3.5-inch drive adapter

Next steps

Replace a 2.5-inch drive into the 3.5-inch drive adapter.

Installing a 2.5-inch drive into the 3.5-inch drive adapter

Prerequisites

1. Follow the safety guidelines listed in [Safety instructions](#).
2. [Remove the drive carrier](#).
3. [Remove 3.5-inch drive adapter from the 3.5-inch drive carrier](#).

Steps

1. Align the screw holes on the 2.5-inch drive with the screw holes on the 3.5-inch drive adapter.
2. Using a Phillips 1 screwdriver, tighten the screws to secure the drive to the 3.5-inch drive adapter.

 **NOTE:** If the 2.5-inch drive has Torx screw, use Torx 6 screwdriver to install the drive to a 3.5-inch drive adapter.



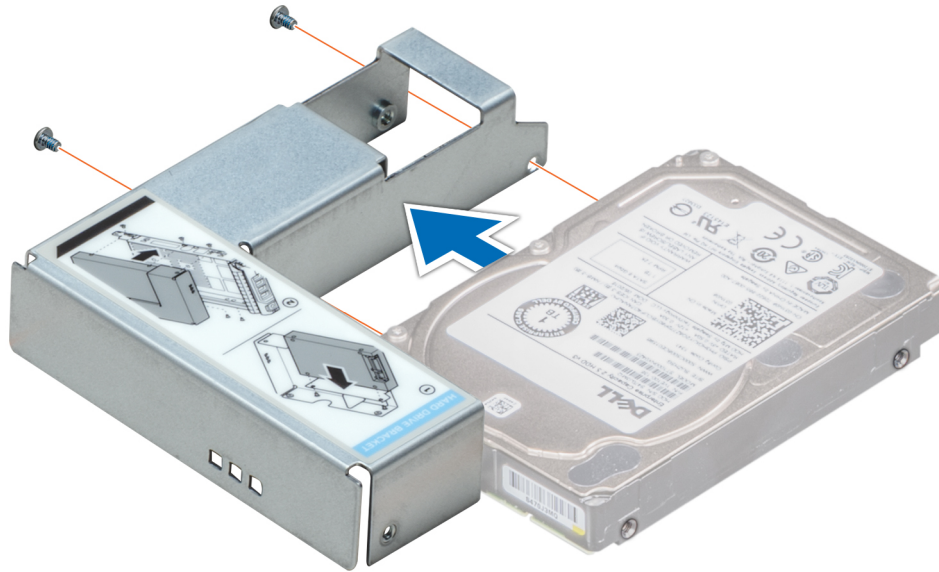

Figure 33. Installing a 2.5-inch drive into the 3.5-inch drive adapter

Next steps

1. Install a 3.5-inch adapter into the 3.5-inch drive carrier.
2. Install the drive carrier.

Optional optical drive

This is a service technician replaceable part only.

Removing the optical drive blank

Prerequisites

1. Follow the safety guidelines listed in [Safety instructions](#).
2. Follow the procedure that is listed in [Before working inside your system](#).
3. [Remove the front bezel](#).

Steps

Press and push the release latch towards the front of the system to remove the optical drive blank.

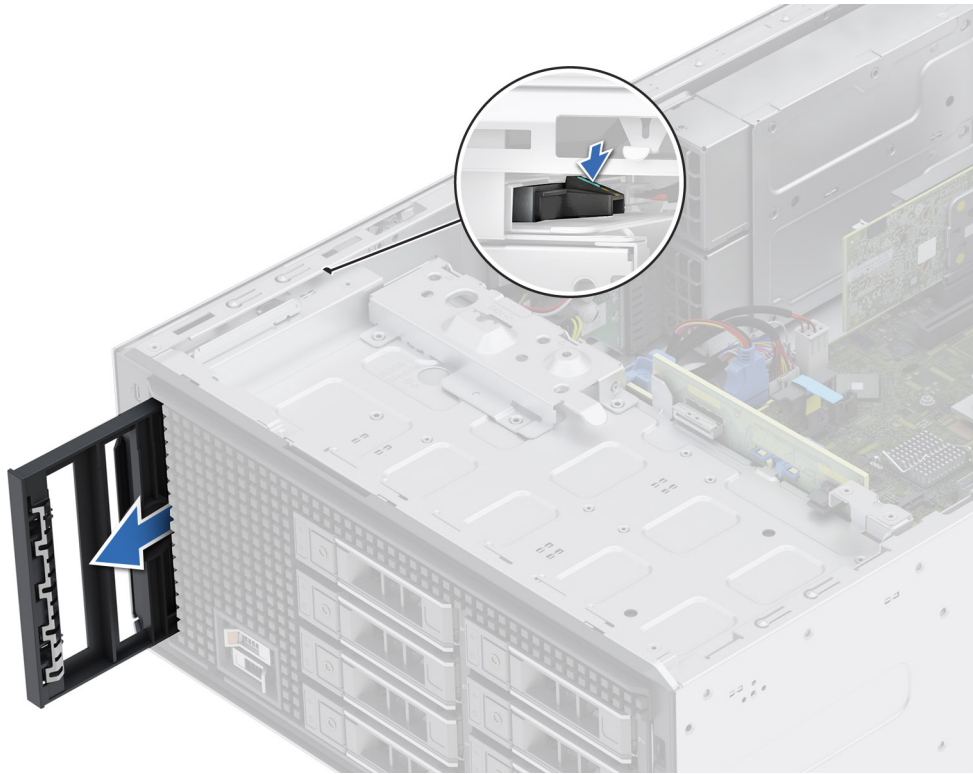

Figure 34. Removing the optical drive blank from the optical drive cage

Next steps

Replace the optical drive blank or install the optical drive.

Installing the optical drive blank

Prerequisites

1. Follow the safety guidelines listed in [Safety instructions](#).
2. Follow the procedure that is listed in [Before working inside your system](#).
3. [Remove the front bezel](#).

Steps

Align and slide the optical drive blank into the optical drive slot until the release latch snaps into place.

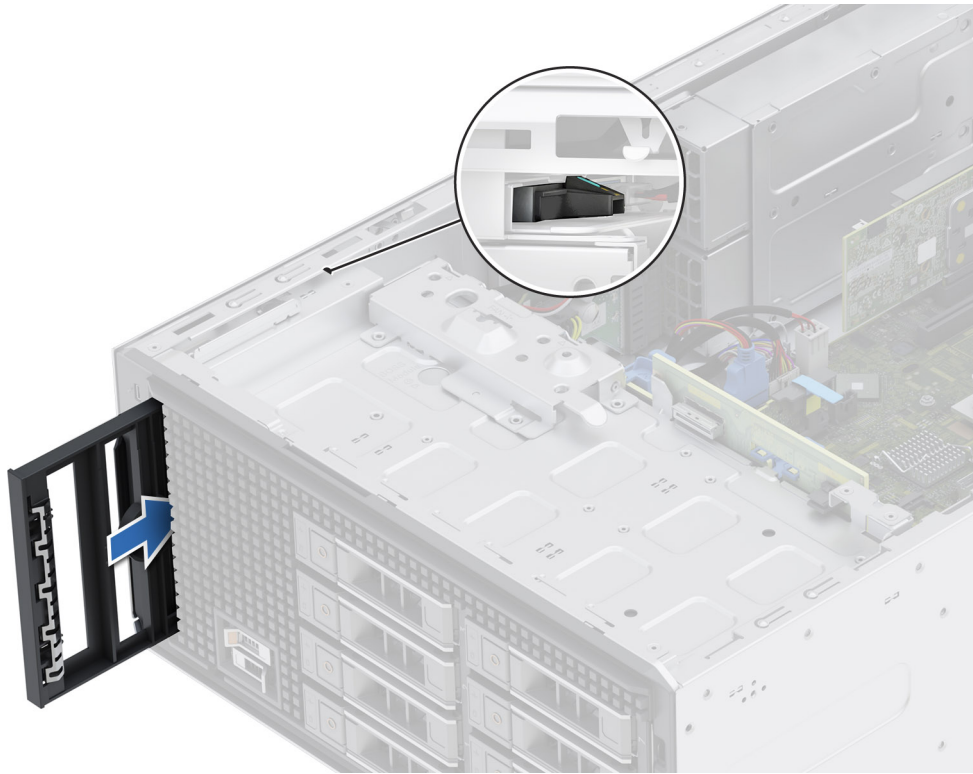

Figure 35. Installing the optical drive blank into the optical drive cage

Next steps

1. [Install the front bezel.](#)
2. Follow the procedure that is listed in [After working inside your system.](#)

Removing the optical drive

Prerequisites

1. Follow the safety guidelines listed in [Safety instructions.](#)
2. Follow the procedure that is listed in [Before working inside your system.](#)
3. [Remove the front bezel.](#)
4. Disconnect the power and data cables from the optical drive.

NOTE: Ensure that you note the routing of the power and data cable as you remove them from the system board and drive.

Steps

1. To release the optical drive, press and push the release tab toward the front of the system.
2. Slide the optical drive out of the system.

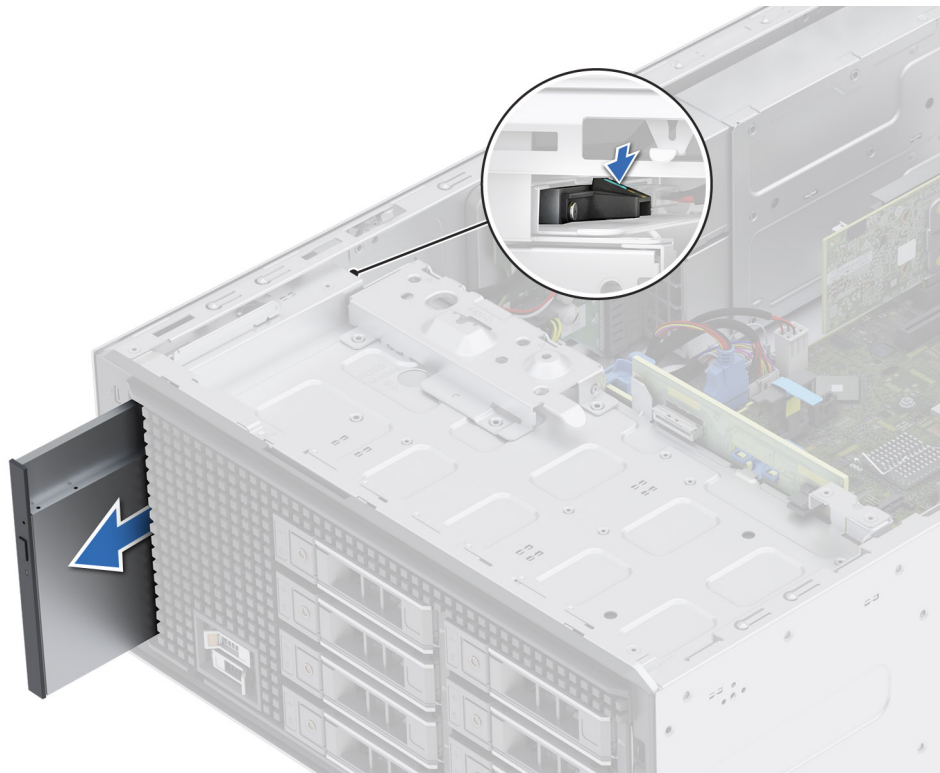

Figure 36. Removing the optical drive

NOTE: If optical drive is not being replaced, install optical drive blank.

Next steps

Replace the optical drive.

Installing the optical drive

Prerequisites

NOTE: Only slim 9.5 mm SATA DVD-ROM drive or DVD+/-RW drive can be installed in your system. External optical drives can be connected through USB ports.

1. Follow the safety guidelines listed in [Safety instructions](#).
2. Follow the procedure that is listed in [Before working inside your system](#).
3. [Remove the front bezel](#).
4. If installed, [Remove the optical drive blank](#).

Steps

1. Align the optical drive with the optical drive slot on the system.
2. Slide the optical drive into the slot until the release tab snaps into place.

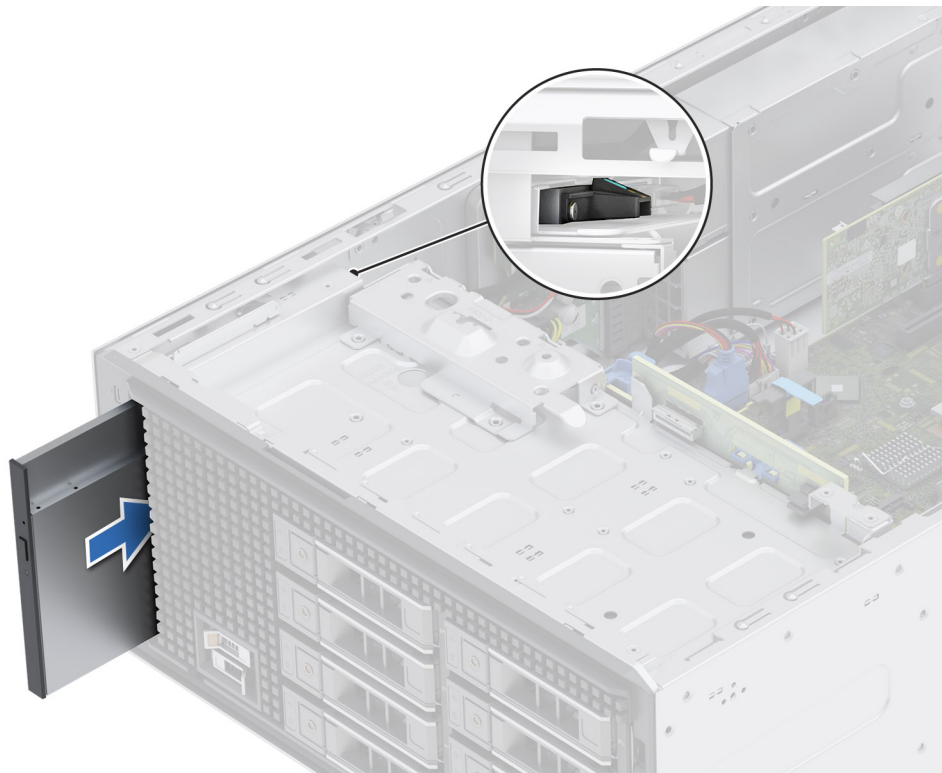

Figure 37. Installing the optical drive

Next steps

1. Connect the power cable and the data cable to the optical drive.

NOTE: Route the cables properly to prevent them from being pinched or crimped.

2. Install the front bezel.
3. Follow the procedure that is listed in [After working inside your system](#).

Drive backplane

This is a service technician replaceable part only.

Drive backplane

Depending on your system configuration, the drive backplanes supported are listed here:

Table 57. Supported backplane option

System	Supported hard drives options
PowerEdge T360	Up to 8 x 3.5-inch SAS/SATA (HDD/SSD) backplane

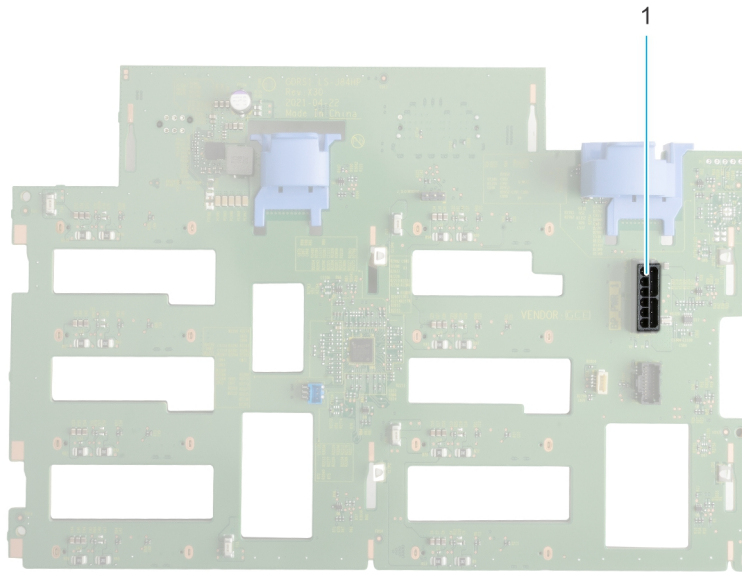

Figure 38. 8 x 3.5-inch drive backplane (front)

1. BP_DST_SA1 (SAS/SATA connector)

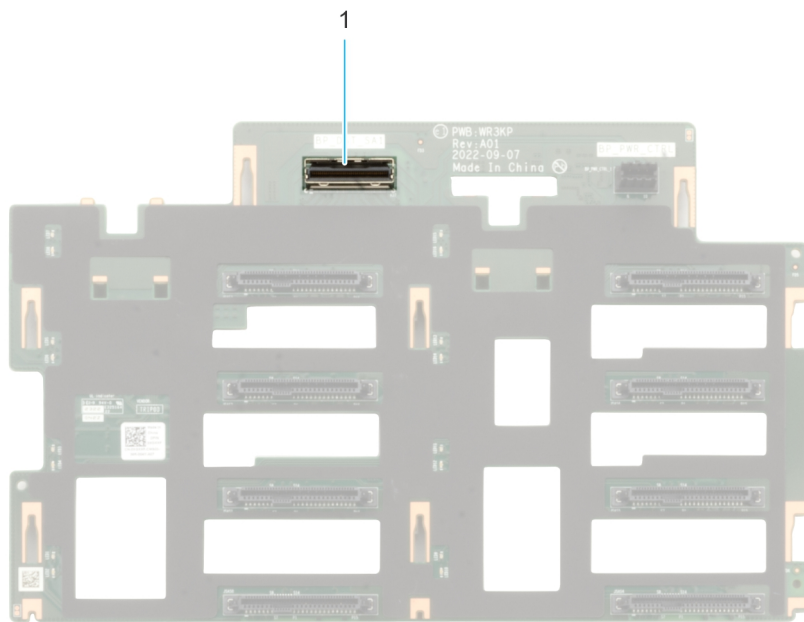

Figure 39. 8 x 3.5-inch drive backplane (rear)

1. BP_PWR_1 (backplane power connector)

Removing the drive backplane

Prerequisites

CAUTION: Note the number of each drive and temporarily label them before you remove the drive so that you can replace them in the same location.

1. Follow the safety guidelines listed in [Safety instructions](#).
2. Follow the procedure listed in [Before working inside your system](#).
3. [Remove the front bezel](#).

4. Remove all the drives

 **CAUTION:** To prevent damage to the drives and backplane, remove the drives from the system before removing the backplane.

5. Remove the air shroud.

6. Disconnect the cables from the drive backplane.

Steps

1. Press the blue release tabs to disengage the drive backplane from the hooks on the system.
2. Lift and pull out the backplane out of the system.

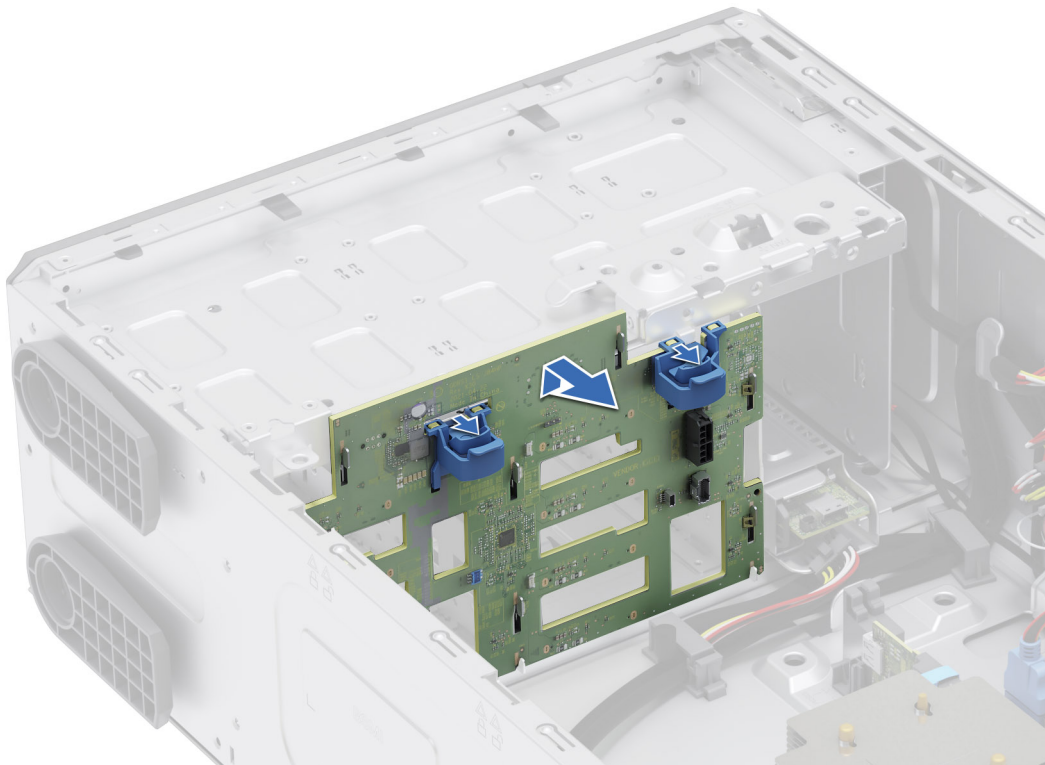

Figure 40. Removing the drive backplane

Next steps

Replace a drive backplane.

Installing the drive backplane

Prerequisites

1. Follow the safety guidelines listed in [Safety instructions](#).
2. Follow the procedure listed in [Before working inside your system](#).
3. [Remove the front bezel](#).
4. [Remove all the drives](#).

 **CAUTION:** To prevent damage to the drives and backplane, remove the drives from the system before removing the backplane.

5. Remove the air shroud.

6. Disconnect the cables from the drive backplane.

Steps

1. Align the slots on the drive backplane with the guides on the system.
2. Slide the drive backplane into the guides and lower the backplane until the blue release tabs clicks into place.

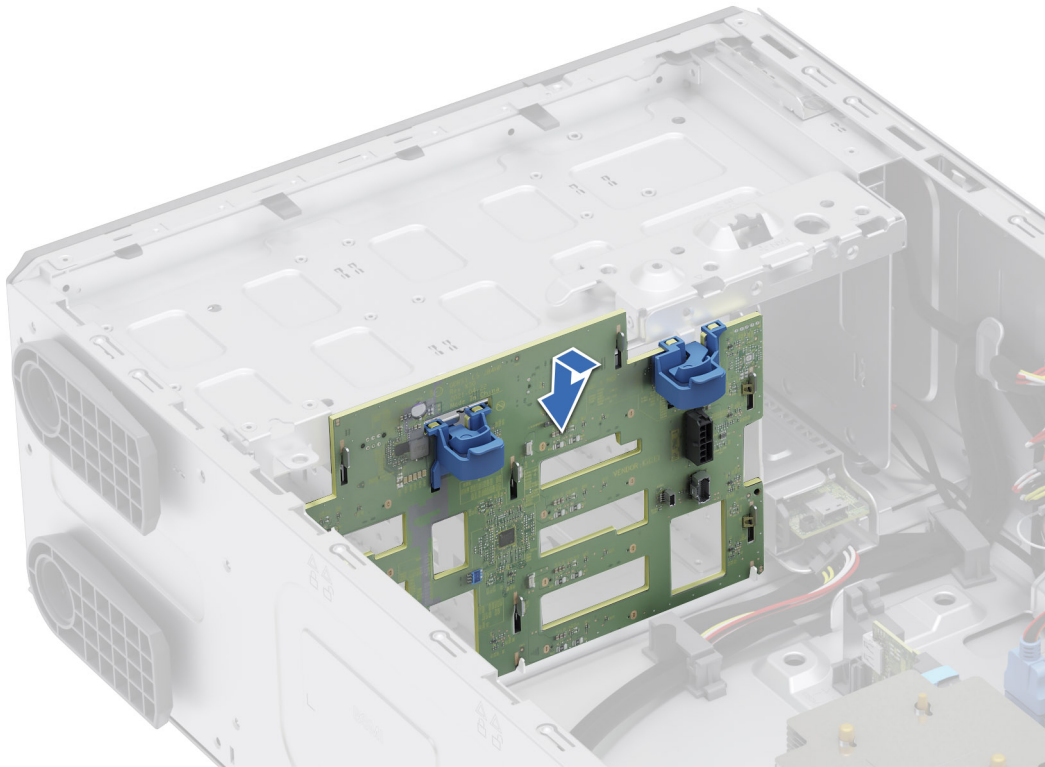

Figure 41. Installing the drive backplane

Next steps

1. Connect the cables into the drive backplane.
2. [Install the air shroud.](#)
3. [Install the drives.](#)
4. [Install the front bezel.](#)
5. Follow the procedure listed in [After working inside your system.](#)

Cooling fans

Removing the cooling fan

Prerequisites

CAUTION: Never operate your system with the fan removed. The system can overheat and result in the shutdown of the system and loss of data.

1. Follow the safety guidelines listed in [Safety instructions.](#)
2. Follow the procedure listed in [Before working inside your system.](#)
3. [Remove the air shroud.](#)

Steps

1. Disconnect the fan cable from the connector on the system board.
2. Holding the fan, press the side release tab, and slide the fan in the direction of the arrow that is marked on the fan to remove it from the system.

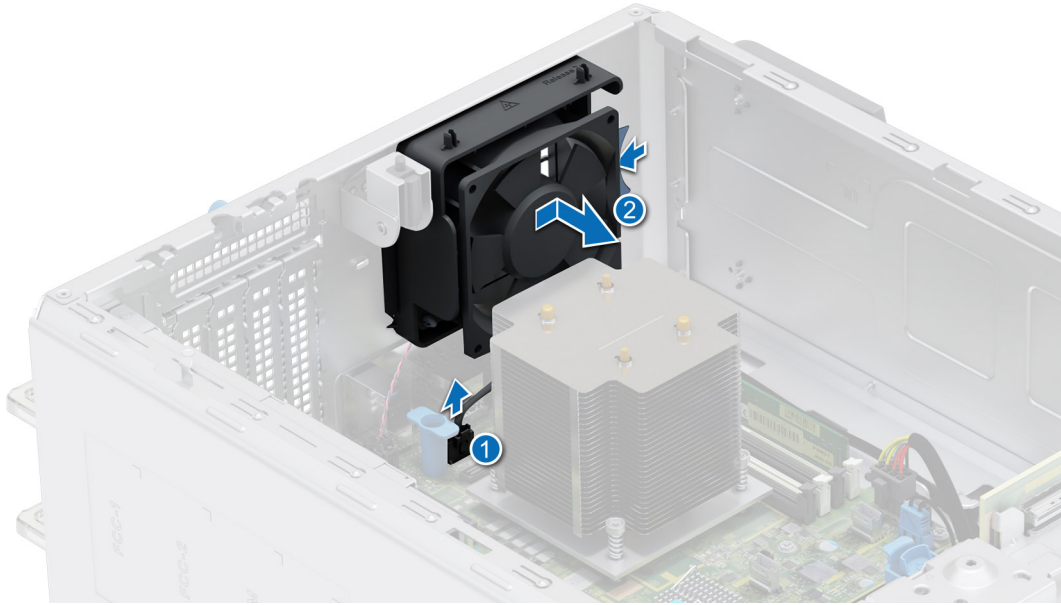

Figure 42. Removing the cooling fan

 **CAUTION:** Do not remove or install the fan by holding the fan blades.

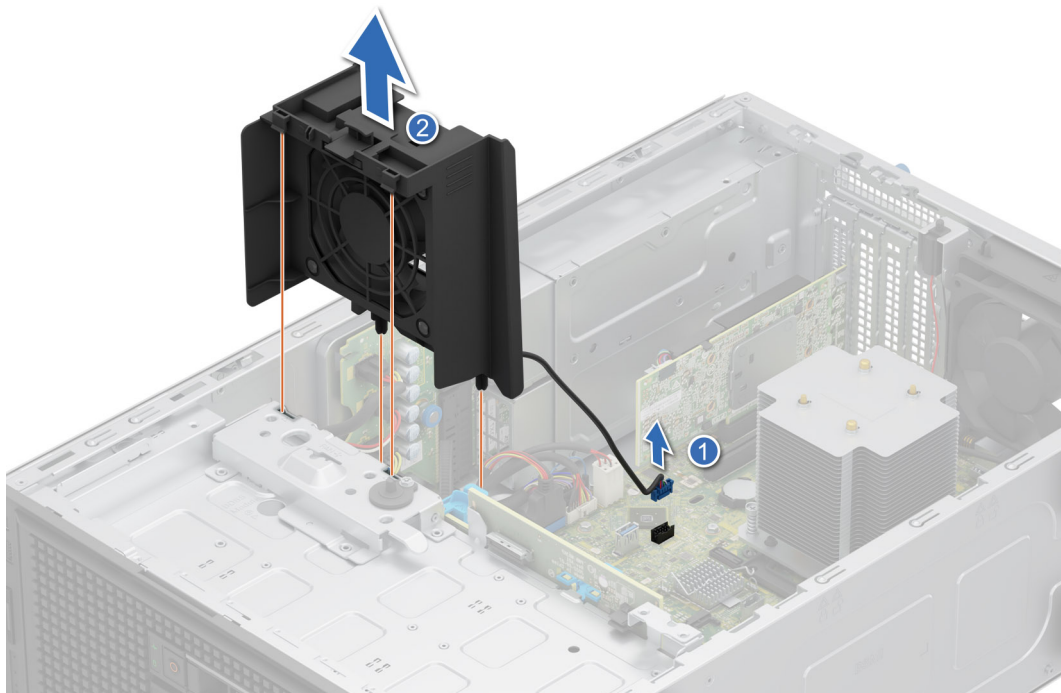

Figure 43. Removing the High Performance (HPR) PCI fan

The High Performance (HPR) PCI fan is needed when BOSS N1 or A2 GPU or >25 W PCIe or Broadcom 10G NIC is installed.

Next steps

1. [Replace the cooling fan.](#)

Installing the cooling fan

Prerequisites

1. Follow the safety guidelines listed in [Safety instructions](#).
2. Follow the procedure listed in [Before working inside your system](#).
3. [Remove the air shroud](#).

Steps

1. Align the four tabs on the fan with the four slots on the system wall.
2. Press and slide the fan into the slots until the release tab locks into place.
3. Connect the fan cable to the connector on the system board.

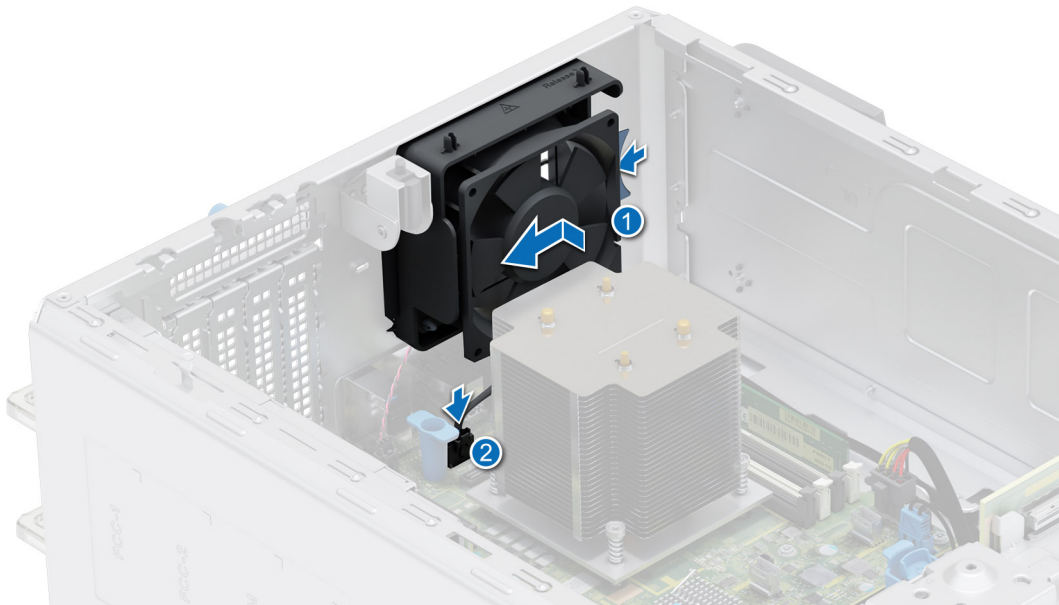

Figure 44. Installing the cooling fan

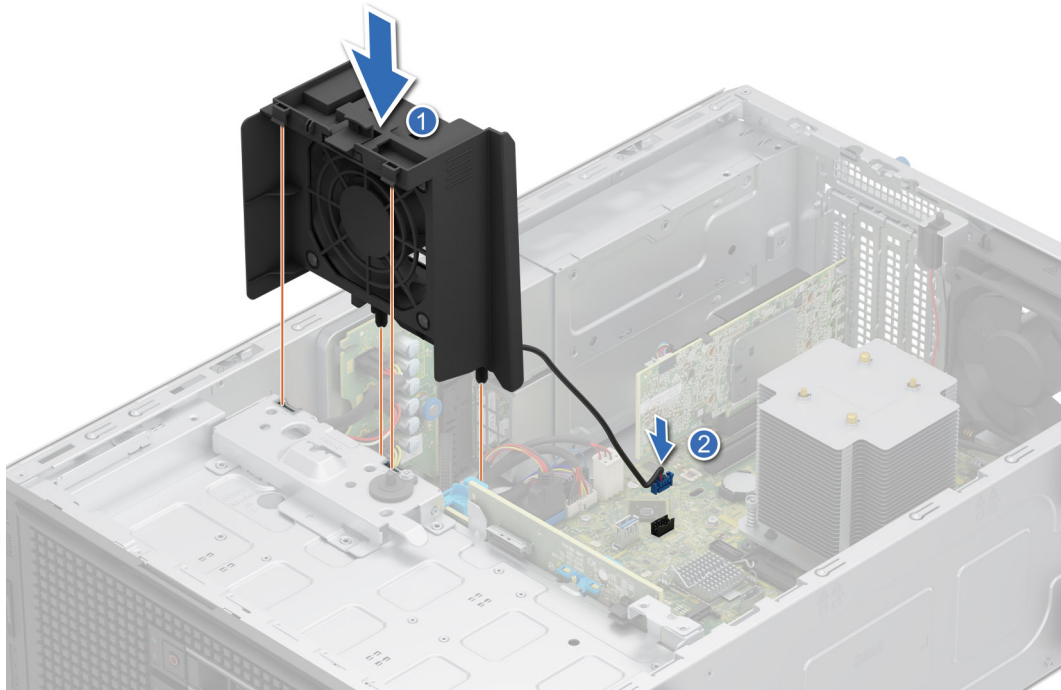

Figure 45. Installing the High Performance (HPR) PCI fan

The High Performance (HPR) PCI fan is needed when BOSS N1 or A2 GPU or >25 W PCIe or Broadcom 10G NIC is installed.

Next steps

1. Install the air shroud.
2. Follow the procedure listed in [After working inside your system](#).

Cable routing

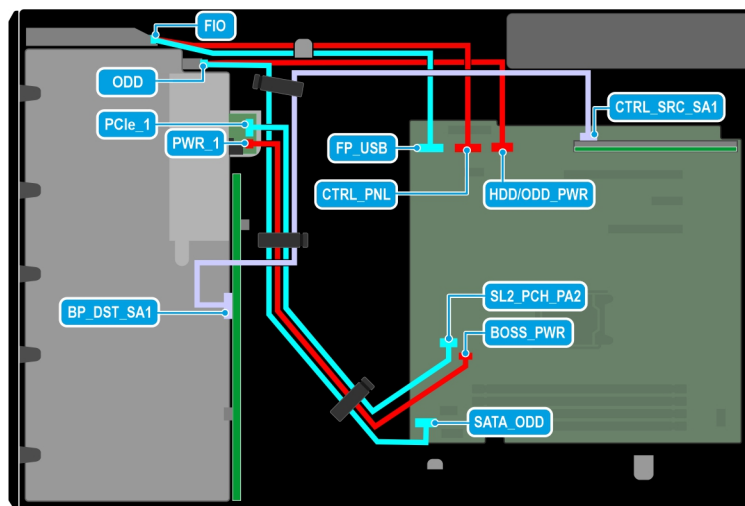

Figure 46. 8 x 3.5-inch drive system

Table 58. Connector descriptions for 8 x 3.5-inch drive system

From	To
CTRL_SRC_SA1 (backplane controller connector on system board)	BP_DST_SA1 (backplane signal connector)
BOSS_PWR (BOSS N1 module power connector on system board)	PWR_1 (BOSS N1 module power connector)
SL2_PCH_PA2 (signal connector on system board)	PCle_1 (BOSS N1 module signal connector)
SATA_ODD (optical disc drive SATA connector on system board) and HDD/ODD_PWR (optical disk drive power connector on system board)	ODD (optical disc drive connector)
FP_USB (front USB connector on system board) and CTRL_PNL (control panel connector on system board)	FIO (control panel connector)

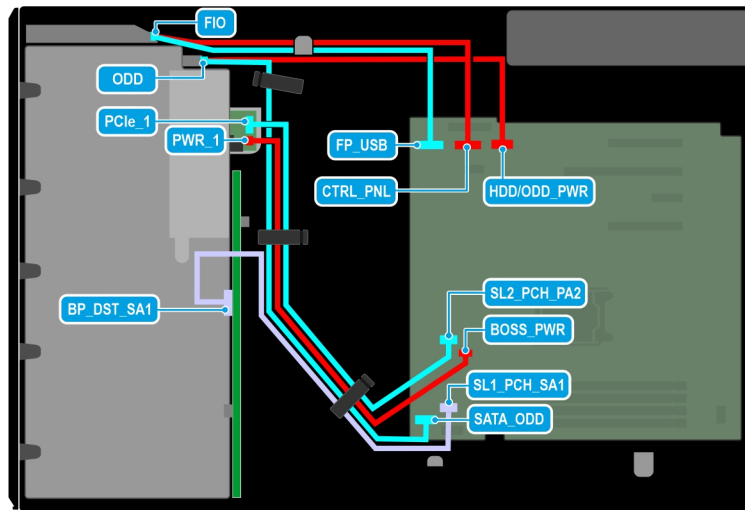

Figure 47. Cable routing - 4 x 3.5-inch drive system

Table 59. Connector descriptions for 4 x 3.5-inch drive system

From	To
SL1_PCH_SA1 (backplane signal connector on system board)	BP_DST_SA1 (backplane signal connector)
BOSS_PWR (BOSS N1 module power connector on system board)	PWR_1 (BOSS N1 module power connector)
SL2_PCH_PA2 (signal connector on system board)	PCle_1 (BOSS N1 module signal connector)
SATA_ODD (optical disc drive SATA connector on system board) and HDD/ODD_PWR (optical disk drive power connector on system board)	ODD (optical disc drive connector)
FP_USB (front USB connector on system board) and CTRL_PNL (control panel connector on system board)	FIO (control panel connector)

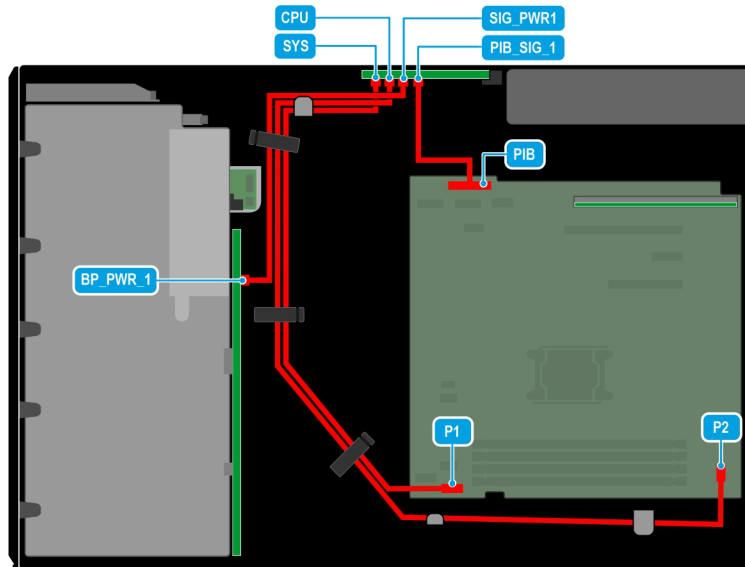

Figure 48. Cable routing - redundant PSU

Table 60. Connector descriptions for redundant PSU

From	To
SYS (system power connector on power interposer board)	P1 (system power connector on system board)
CPU (processor power connector on power interposer board)	P2 (processor power connector on system board)
SIG_PWR_1 (backplane power connector on power interposer board)	BP_PWR_1 (backplane power connector)
PIB_SIG_1 (power interposer board signal connector)	PIB (Power interposer board connector on system board)

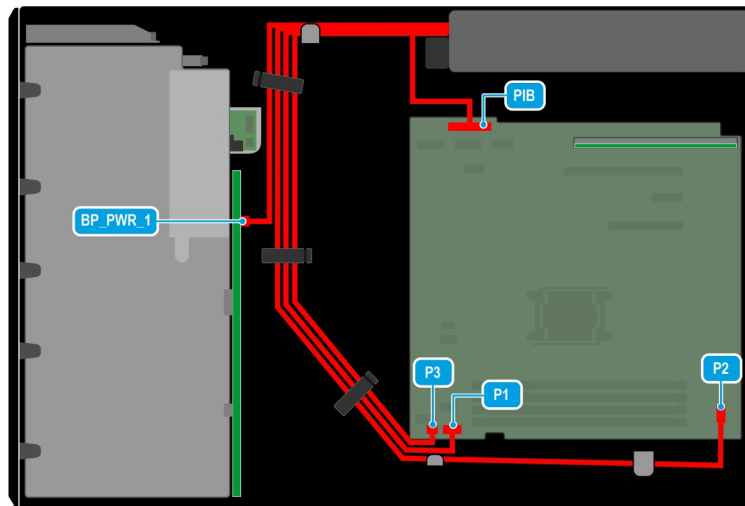

Figure 49. Cable routing - cabled PSU

Table 61. Connector descriptions for cabled PSU

From	To
Power cables from the PSU	P1 (system power connector on system board)
	P2 (processor power connector on system board)
	P3 (power event connector on system board)
	BP_PWR_1 (backplane power connector)

Table 61. Connector descriptions for cabled PSU (continued)

From	To
	PIB (Power interposer board connector on system board)

System memory

General memory module installation guidelines

To ensure optimal performance of your system, observe the following general guidelines when configuring your system memory. If your system's memory configuration fails to observe these guidelines, your system might not boot, stop responding during memory configuration, or operate with reduced memory.

The memory bus may operate at speeds of 4400 MT/s, 4000 MT/s or 3600 MT/s depending on the following factors:

- System profile selected (for example, Performance, Performance Per Watt Optimized (OS), or Custom [can be run at high speed or lower])
- Maximum supported DIMM speed of the processors
- Maximum supported speed of the DIMMs
- DIMM rank

NOTE: MT/s indicates DIMM speed in Mega-Transfers per second.

The following are the recommended guidelines for installing memory modules:

- All DIMMs must be DDR5.
- If memory modules with different speeds are installed, they operate at the speed of the slowest installed memory module(s).
- Populate memory module sockets only if a processor is installed.
 - For single-processor systems, sockets A1 to A4 are available.
 - A minimum of 1 DIMM must be populated for the installed processor.
- In **Optimizer Mode**, the DRAM controllers operate independently in the 64-bit mode and provide optimized memory performance.

Table 62. Memory population rules

Processor	Memory population	Memory population information
Single processor	A{1}, A{2}, A{3}, A{4}	1, 2, 4 DIMMs are allowed

- Populate all the sockets with white release tabs first.
- Unbalanced or odd memory configurations result in a performance loss, and the system may not identify the memory modules being installed. Always populate memory channels identically with equal DIMMs for the best performance.

NOTE: Equal memory modules refer to DIMMs with identical electrical specification and capacity that may be from different vendors.

Removing a memory module

Prerequisites

1. Follow the safety guidelines listed in the [Safety instructions](#).
2. Follow the procedure listed in [Before working inside your system](#).
3. [Remove the air shroud](#).

WARNING: The memory modules are hot to touch for some time after the system has been powered off. Allow the memory modules to cool before handling them.

NOTE: To ensure proper system cooling, memory module blanks must be installed in any memory socket that is not occupied. Remove the memory module blanks only if you intend to install memory modules in these sockets.

Steps

1. Locate the appropriate memory module socket.
2. To release the memory module from the socket, simultaneously press the ejectors on both ends of the memory module socket to fully open.

CAUTION: Handle each memory module only by the card edges, ensuring not to touch the middle of the memory module or metallic contacts.

3. Lift the memory module away from the system.

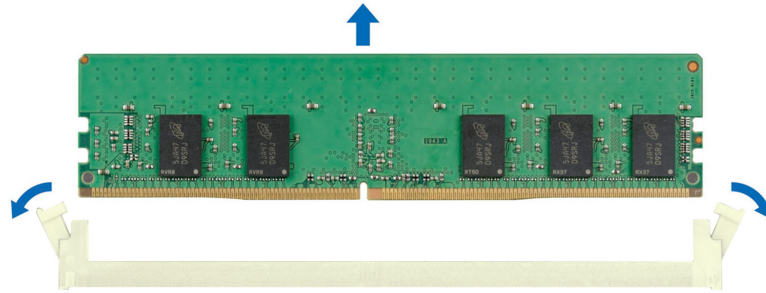

Figure 50. Removing a memory module

Next steps

Replace the memory module.

Installing a memory module

Prerequisites

1. Follow the safety guidelines listed in the [Safety instructions](#).
2. Follow the procedure listed in [Before working inside your system](#).
3. [Remove the air shroud](#).

Steps

1. Locate the appropriate memory module socket.

CAUTION: Handle each memory module only by the card edges, ensuring not to touch the middle of the memory module or metallic contacts.

NOTE: Ensure that the socket ejector latches are fully open before installing the memory module.

2. Align the edge connector of the memory module with the alignment key of the memory module socket, and insert the memory module in the socket.

CAUTION: To prevent damage to the memory module or the memory module socket during installation, do not bend or flex the memory module; insert both ends of the memory module simultaneously.

NOTE: The memory module socket has an alignment key that enables you to install the memory module in the socket in only one orientation.

CAUTION: Do not apply pressure at the center of the memory module; apply pressure at both ends of the memory module evenly.

3. Press the memory module with your thumbs until the ejectors firmly click into place. When the memory module is properly seated in the socket, the levers on the memory module socket align with the levers on the other sockets that have memory modules that are installed.

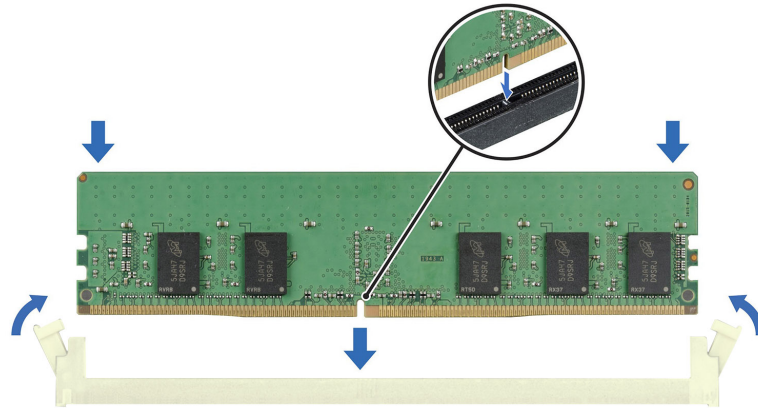

Figure 51. Installing a memory module

Next steps

1. [Install the air shroud.](#)
2. Follow the procedure listed in [After working inside your system.](#)
3. To verify that the memory module has been installed properly, press F2 during reboot and navigate to **System Setup Main Menu > System BIOS > Memory Settings**. In the **Memory Settings** screen, the System Memory Size must reflect the updated capacity of the installed memory.
4. If the System Memory Size is incorrect, one or more of the memory modules may not be installed properly. Shut down the system and ensure that the memory modules are firmly seated in the correct sockets.
5. Run the system memory test in system diagnostics.

Processor and heat sink

This is a service technician replaceable part only.

Removing the heat sink

Prerequisites

WARNING: The heat sink may be hot to touch for some time after the system has been powered off. Allow the heat sink to cool before removing it.

1. Follow the safety guidelines listed in the [Safety instructions](#).
2. Follow the procedure listed in [Before working inside your system.](#)
3. [Remove the air shroud.](#)

Steps

1. Using a Phillips 2 screwdriver, loosen the captive screws on the heat sink in the order mentioned below:
 - a. Loosen the first captive screw three turns.

- b. Loosen the captive screw diagonally opposite to the screw you loosened first.
 - c. Repeat the procedure for the remaining two captive screws.
 - d. Return to the first screw to loosen it completely.
2. Lift the heat sink away from the system.

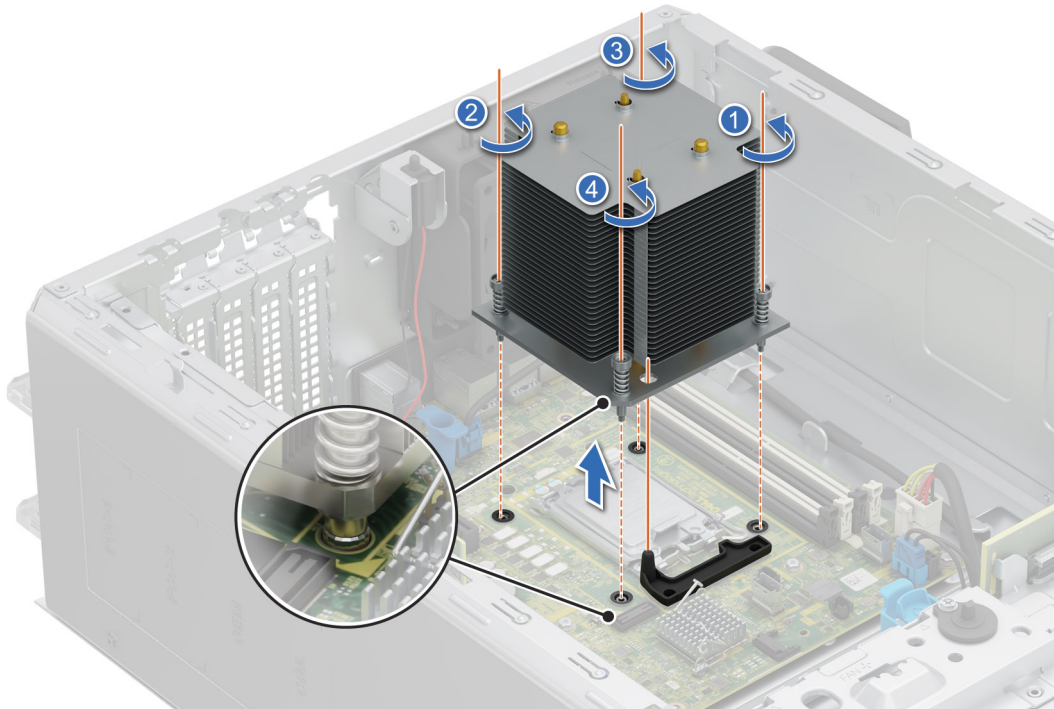

Figure 52. Removing the heat sink

Next steps

Replace the heat sink.

Removing the processor

Prerequisites

⚠ WARNING: The processor will be hot to touch for some time after the system has been powered down. Allow the processor to cool before removing it.

⚠ CAUTION: The processor is held in its socket under strong pressure. Be aware that the release lever can spring up suddenly if not firmly held.

i NOTE: Only remove the processor if you are replacing the processor or system board. This procedure is not required when replacing a heat sink module.

1. Follow the safety guidelines listed in the [Safety instructions](#).
2. Follow the procedure listed in [Before working inside your system](#).
3. [Remove the heat sink module](#).

Steps

1. Release the socket lever by pushing the lever down and out from under the tab on the processor shield.
2. Lift the lever upward until the processor shield lifts.

CAUTION: The processor socket pins are fragile and can be permanently damaged. Be careful not to bend the pins in the processor socket when removing the processor out of the socket.

3. Lift the processor out of the socket.

NOTE: Ensure that the processor and the bracket are placed in the tray after you remove the heat sink.

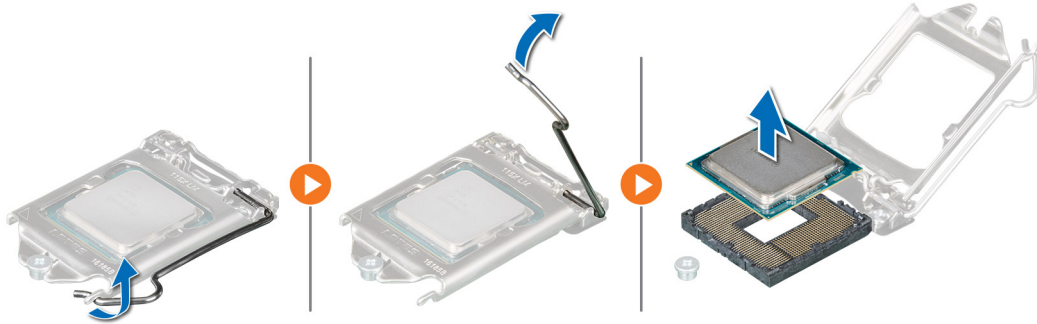

Figure 53. Removing the processor

Next steps

Replace the processor.

Installing the processor

Prerequisites

CAUTION: Never remove the heat sink from a processor unless you intend to replace the processor. The heat sink is necessary to maintain proper thermal conditions.

1. Follow the safety guidelines listed in the [Safety instructions](#).
2. Follow the procedure listed in [Before working inside your system](#).
3. [Remove the processor](#).

Steps

1. Align the pin 1 indicator of the processor with the triangle on the socket and place the processor on the socket.

CAUTION: Positioning the processor incorrectly can permanently damage the system board or the processor. Be careful not to bend the pins in the socket.

2. Lower the socket lever and push it under the tab to lock it.

NOTE: If the processor has previously been used in a system, remove any remaining thermal grease from the processor by using a lint-free cloth.

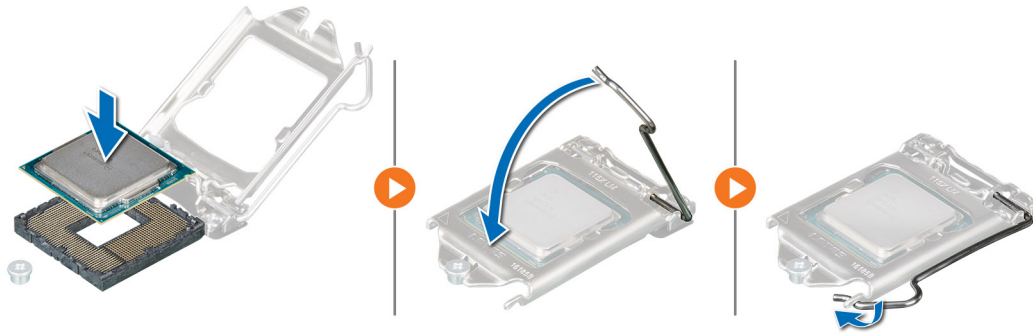

Figure 54. Installing the processor

Next steps

i **NOTE:** Ensure that you install the heat sink after you install the processor. The heat sink is necessary to maintain proper thermal conditions.

1. [Install the heat sink module.](#)
2. Follow the procedure listed in [After working inside your system.](#)

Installing the heat sink

Prerequisites

⚠ CAUTION: Never remove the heat sink from a processor unless you intend to replace the processor. The heat sink is necessary to maintain proper thermal conditions.

1. Follow the safety guidelines listed in the [Safety instructions.](#)
2. Follow the procedure listed in [Before working inside your system.](#)
3. If removed, [install the processor.](#)

Steps

1. If you are using an existing heat sink, remove the thermal grease from the heat sink by using a clean lint-free cloth.
2. Use the thermal grease syringe included with your processor kit to apply the grease in a quadrilateral design on the top of the processor.

⚠ CAUTION: Applying too much thermal grease can result in excess grease coming in contact with and contaminating the processor socket.

i **NOTE:** The thermal grease syringe is intended for single use only. Dispose the syringe after you use it.

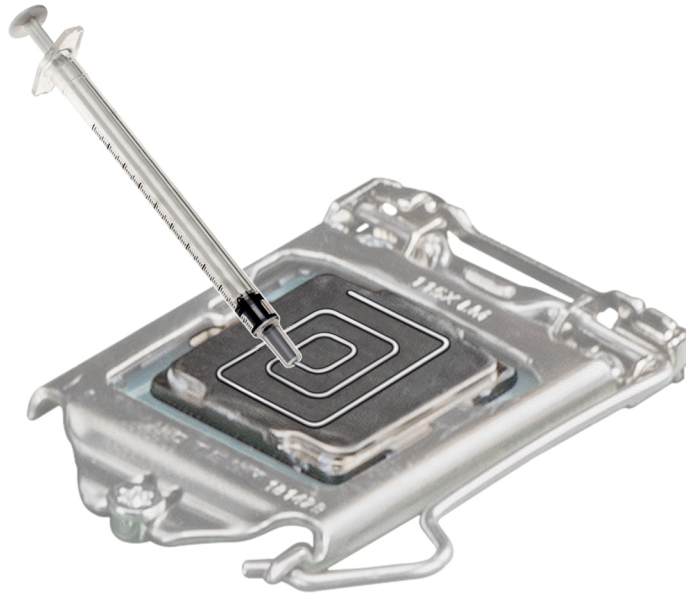

Figure 55. Applying thermal grease on top of the processor

3. Align the captive screws on the heat sink with the hole on the system board.
4. Using the Phillips 2 screwdriver, tighten the captive screws on the heat sink in the order below:
 - a. In a random order, tighten the captive screws three turns.
 - b. Tighten the captive screw diagonally opposite to the screw you tighten first.
 - c. Repeat the procedure for the remaining two captive screws.
 - d. Return to the first screw to tighten it completely.
 - e. Check all the captive screws to ensure they are firmly secured.

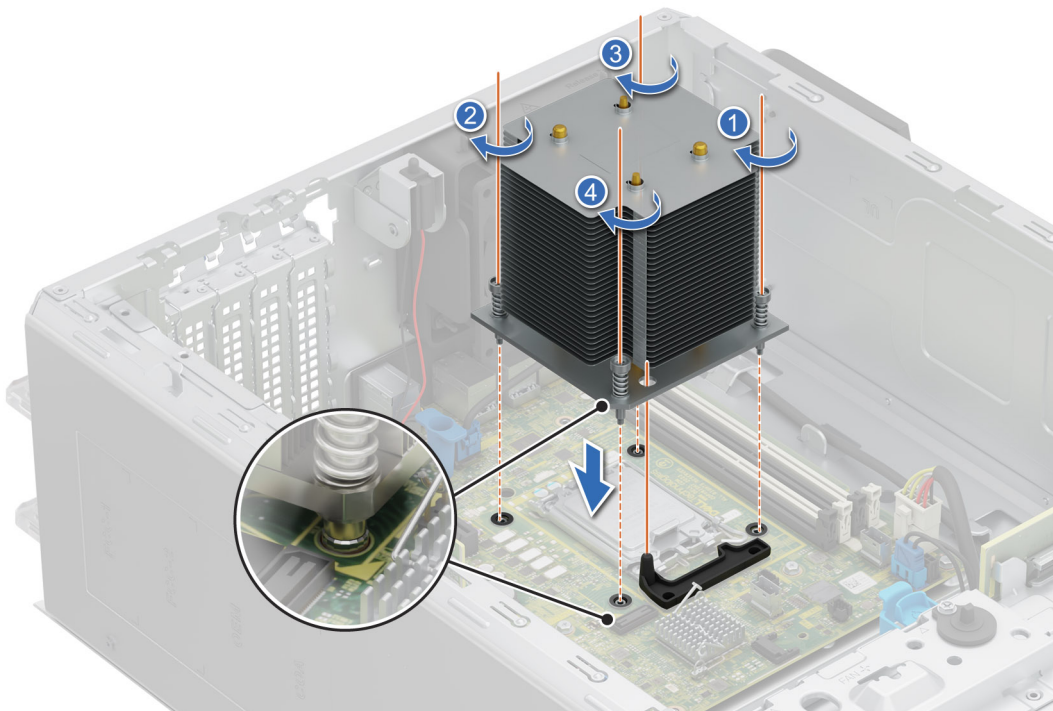

Figure 56. Installing the heat sink

Next steps

1. [Install the air shroud.](#)
2. Follow the procedure listed in [After working inside your system.](#)
3. While booting, press **F2** to enter **System Setup** and check that the processor information matches the new system configuration.
4. Run the system diagnostics to verify that the new processor operates correctly.

Expansion cards and expansion card risers

NOTE: When an expansion card is not supported or missing, the iDRAC and Lifecycle Controller logs an event. This does not prevent your system from booting. However, if a F1/F2 pause occurs with an error message, see Troubleshooting expansion cards section in the PowerEdge Servers Troubleshooting Guide at [PowerEdge Manuals](#).

Expansion card installation guidelines

The following table describes the supported expansion cards and riser configurations:

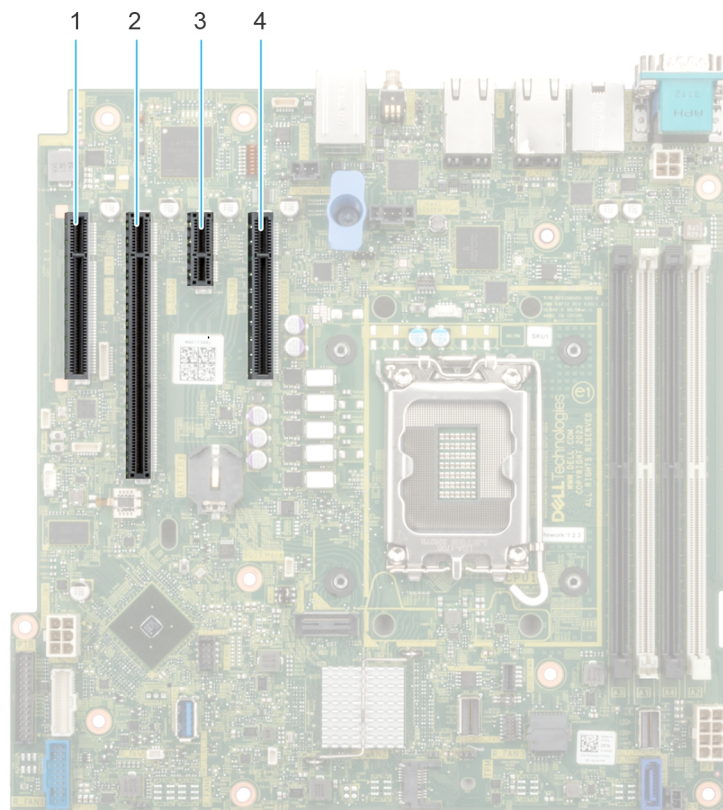



Figure 57. Expansion card slot connectors

- | | |
|-----------|-----------|
| 1. Slot 1 | 2. Slot 2 |
| 3. Slot 3 | 4. Slot 4 |

The following table describes the expansion card riser configurations:

Table 63. Expansion card slots supported on the system board

PCIe slot	Risers	Processor connection	PCIe slot height	PCIe slot length	PCIe slot width (Electrical)	PCIe slot width (Physical)
Slot 1 (Gen4)	N/A	Processor 1	Full Height	Half Length	x4	x8
Slot 2 (Gen5)	N/A	Processor 1	Full Height	Half Length	x16	x16
Slot 3 (Gen4)	N/A	Platform Controller Hub	Full Height	Half Length	x1	x1
Slot 4 (Gen4)	N/A	Platform Controller Hub	Full Height	Half Length	x4	x8

 **NOTE:** The expansion-card slots are not hot-swappable.

The following table provides guidelines for installing expansion cards to ensure proper cooling and mechanical fit. The expansion cards with the highest priority should be installed first using the slot priority indicated. All the other expansion cards should be installed in the card priority and slot priority order.

Table 64. Configuration : No Riser

Card type	Slot priority	Maximum number of cards
NVIDIA (GPU)	2	1
FOXCONN (aPERC 11)	2,1	1
FOXCONN (aPERC HBA11)	2,1	1
FOXCONN (External Adapter)	2,1	2
Broadcom (NIC:1Gb)	2,1,4	3
Intel (NIC:10Gb)	2,1,4	3
Broadcom (NIC:10Gb)	2,1,4	3
Intel (NIC:1Gb)	2,1,4	3
FOXCONN (BOSS-N1)	INT	1
Broadcom (NIC:25Gb)	2,1,4	3
Intel (NIC:25Gb)	2,1,4	3

Removing an expansion card

Prerequisites

1. Follow the safety guidelines listed in [Safety instructions](#).
2. Follow the procedure listed in [Before working inside your system](#).
3. If required, [remove the air shroud](#).
4. Disconnect any cables that are connected to the expansion card.

Steps

1. Loosen the captive screw and tilt the metal bracket that holds the expansion cards.
2. Hold the expansion card by the edges, and pull the card up to remove it from the expansion card connector on the system board.

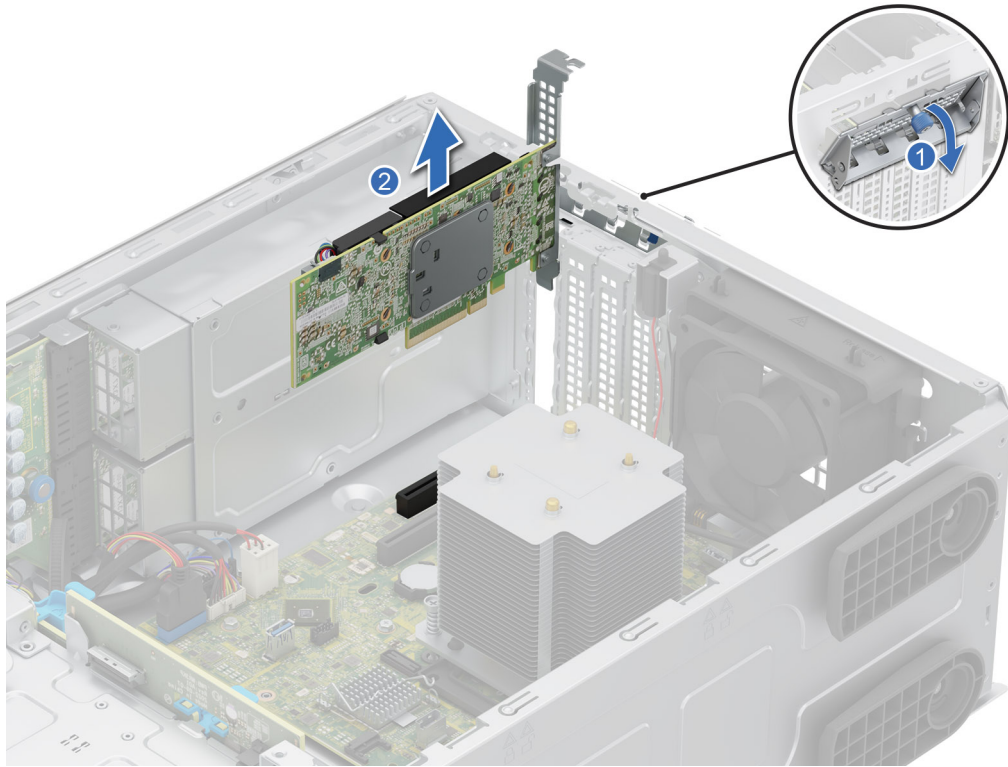

Figure 58. Removing an expansion card

3. If the expansion card is not going to be replaced, install metal filler.
4. Tilt the metal bracket and tighten the captive screw.

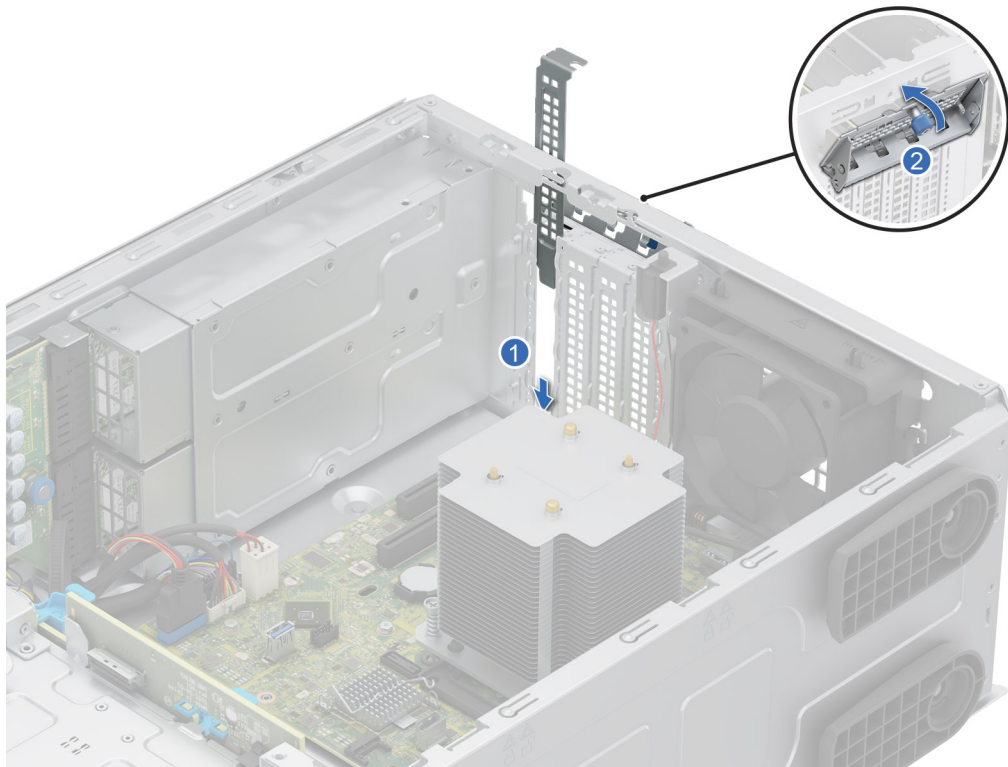

Figure 59. Installing the metal filler

NOTE: Filler brackets must be installed in empty expansion-card slots to maintain FCC certification of the system. The brackets also keep dust and dirt out of the system and aid in proper cooling and airflow inside the system.

Next steps

Replace an expansion card.

Installing an expansion card

Prerequisites

1. Follow the safety guidelines listed in [Safety instructions](#).
2. Follow the procedure listed in [Before working inside your system](#).
3. If required, [remove the air shroud](#).

Steps

1. Loosen the captive screw and tilt the metal bracket that holds the metal filler.

NOTE: Store this bracket for future use. Filler brackets must be installed in empty expansion-card slots to maintain FCC certification of the system. The brackets also keep dust and dirt out of the system and aid in proper cooling and airflow inside the system.

2. Lift the metal filler out of the system.

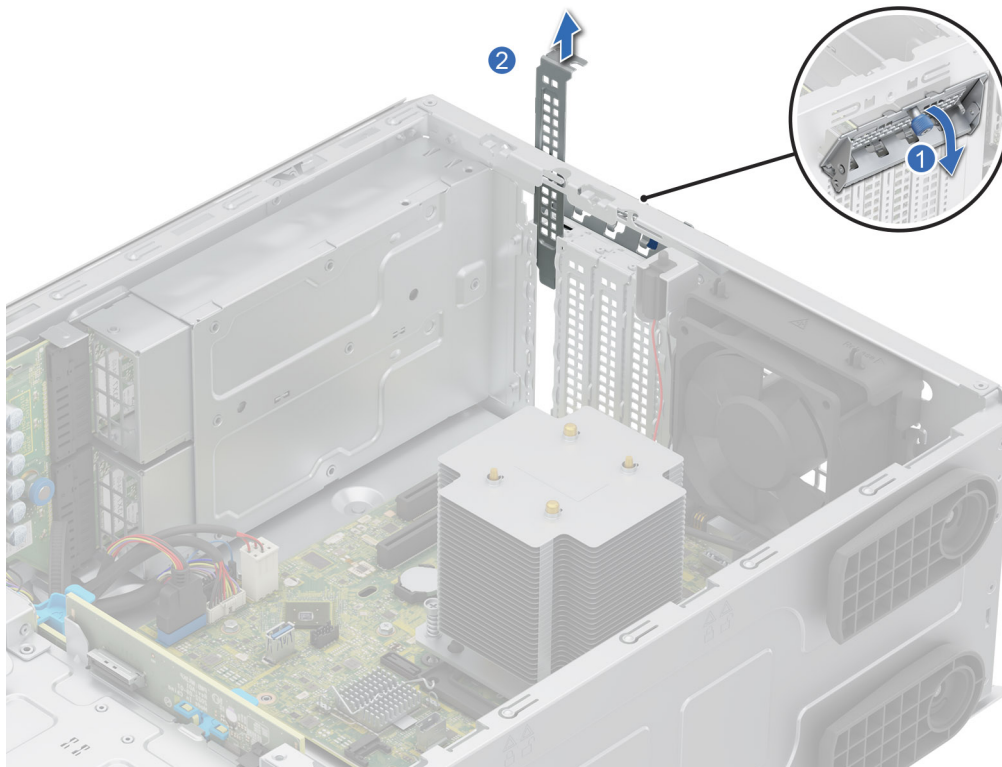

Figure 60. Removing the metal filler

3. Holding the card by the edges, align the card with the expansion card slot on the system board.
4. Insert the card firmly into the expansion card slot until the card is firmly seated.

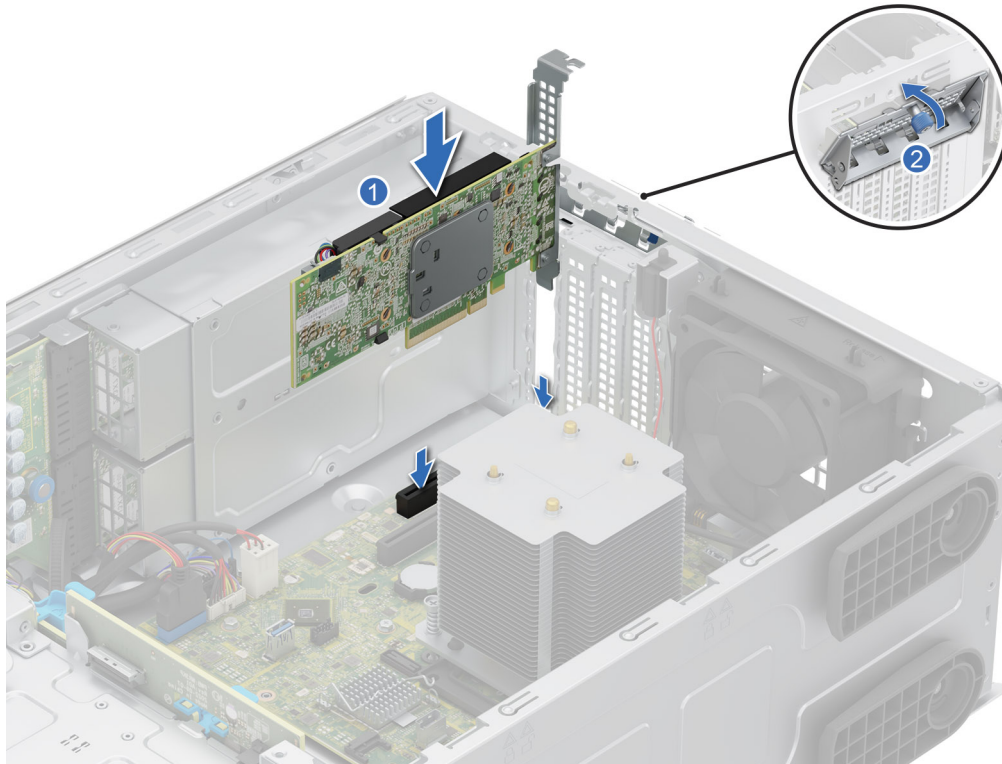

Figure 61. Installing an expansion card

5. Tilt the metal bracket and tighten the captive screw.

Next steps

1. If required, reconnect the cables to the expansion card.
2. [Install the air shroud.](#)
3. Follow the procedure listed in [After working inside your system.](#)

Removing the GPU

Prerequisites

1. Follow the safety guidelines listed in [Safety instructions.](#)
2. Follow the procedure listed in [Before working inside your system.](#)
3. If required, [remove the air shroud.](#)

Steps

1. Loosen the captive screw and tilt the metal bracket that holds the expansion cards.
2. Hold the GPU by the edges, and pull the card up to remove it from the expansion card connector on the system board.

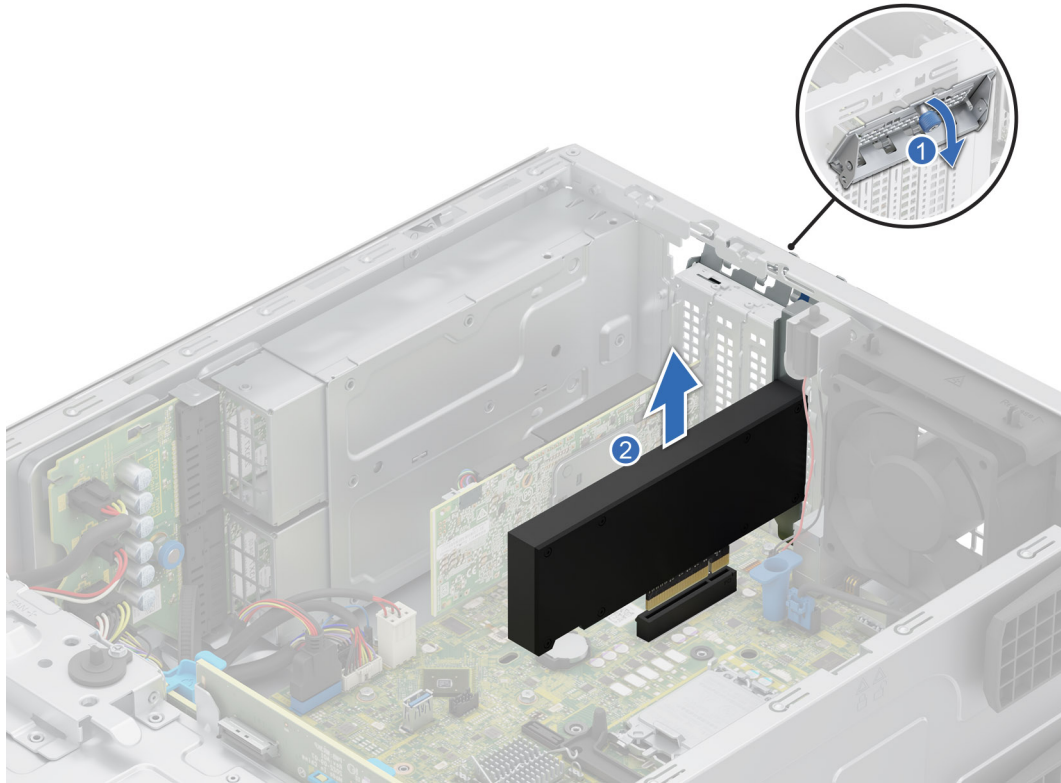

Figure 62. Removing the GPU

3. If the GPU is not going to be replaced, install metal filler.
4. Tilt the metal bracket and tighten the captive screw.

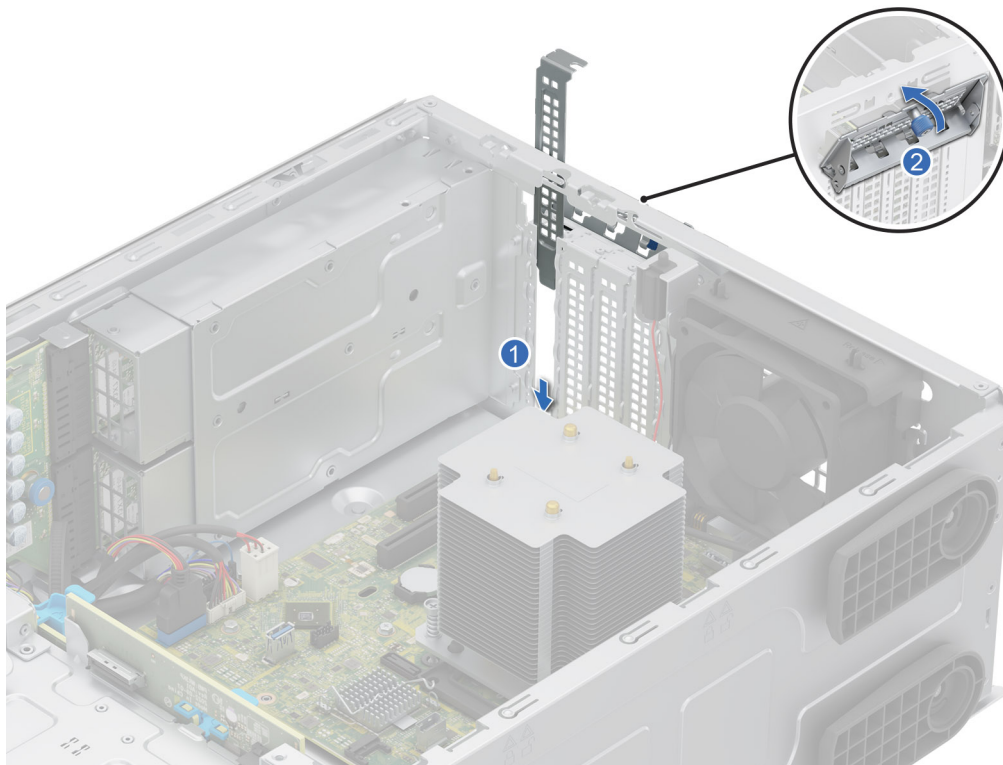

Figure 63. Installing the metal filler

NOTE: Filler brackets must be installed in empty GPU slots to maintain FCC certification of the system. The brackets also keep dust and dirt out of the system and aid in proper cooling and airflow inside the system.

Next steps

Replace the GPU.

Installing the GPU

Prerequisites

1. Follow the safety guidelines listed in [Safety instructions](#).
2. Follow the procedure listed in [Before working inside your system](#).
3. If required, [remove the air shroud](#).

Steps

1. Loosen the captive screw and tilt the metal bracket that holds the metal filler.

NOTE: Store this bracket for future use. Filler brackets must be installed in empty GPU slots to maintain FCC certification of the system. The brackets also keep dust and dirt out of the system and aid in proper cooling and airflow inside the system.

2. Lift the metal filler out of the system.

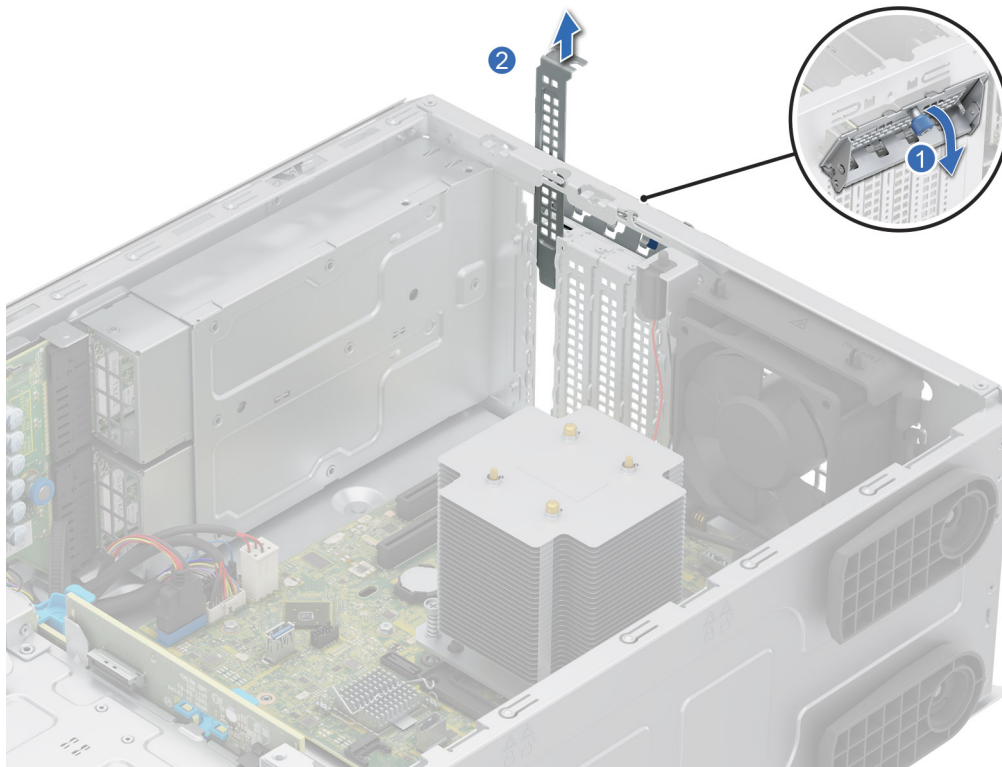

Figure 64. Removing the metal filler

3. Holding the GPU by the edges, align the card with the expansion card slot on the system board.
4. Insert the GPU firmly into the expansion card slot until the card is firmly seated.

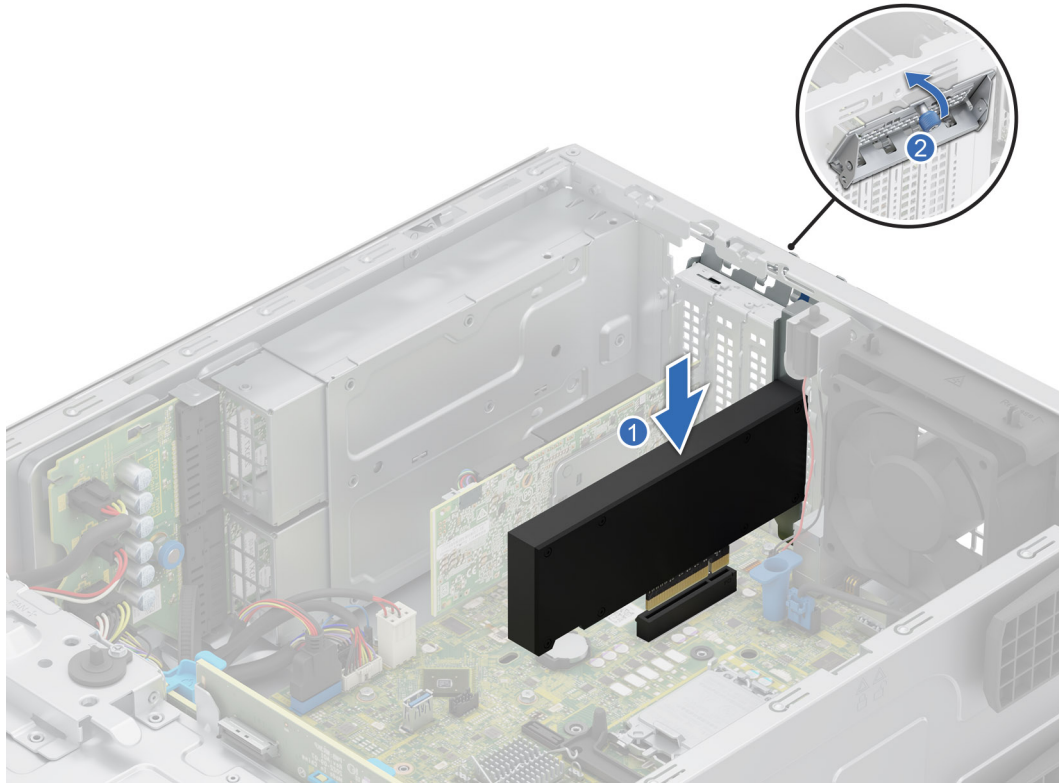

Figure 65. Installing the GPU

5. Tilt the metal bracket and tighten the captive screw.

Next steps

1. [Install the air shroud.](#)
2. Follow the procedure listed in [After working inside your system.](#)

Optional BOSS-N1 module

Removing the BOSS-N1 module

Prerequisites

1. Follow the safety guidelines listed in [Safety instructions.](#)
2. Follow the procedure that is listed in [Before working inside your system.](#)
3. [Remove the air shroud.](#)
4. If installed, [remove the front bezel.](#)

Steps

1. Disconnect the cables connected to the system board from the BOSS-N1 module.
2. Using a Phillips 2 screwdriver, remove the screw securing the BOSS-N1 module to the system.
3. Slide the BOSS-N1 module out of the system.

NOTE: The numbers on the image do not depict the exact steps. The numbers are for representation of sequence.

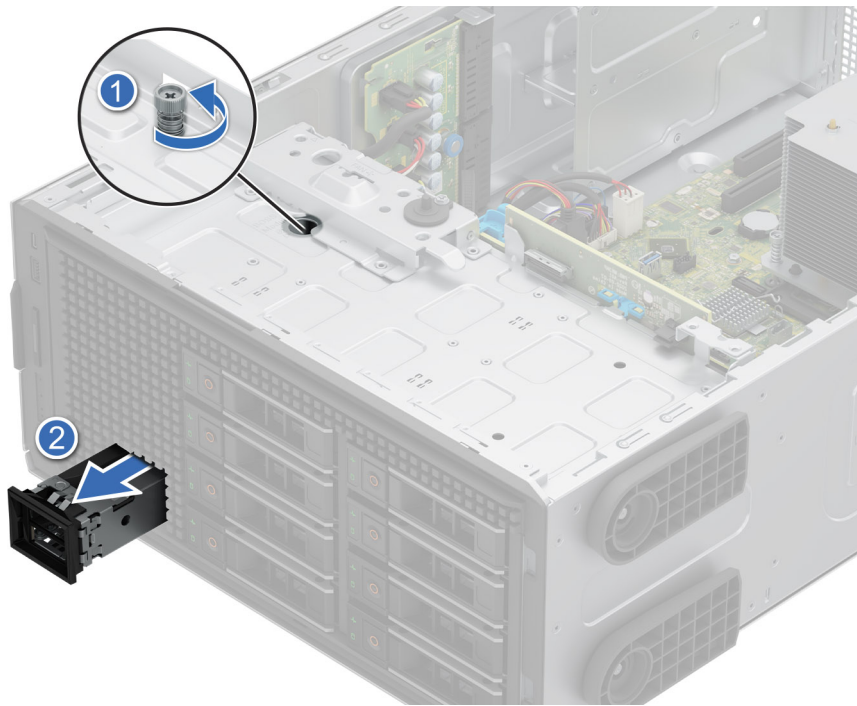

Figure 66. Removing the BOSS-N1 module

4. Align the blank with the BOSS-N1 module slot and push it into the bay until it clicks into place.

i **NOTE:** Blanks must be installed in empty slots to maintain FCC certification of the system. The blanks also keep dust and dirt out of the system and aid in proper cooling and airflow inside the system.



Figure 67. Installing the BOSS-N1 module blank

5. Using a Phillips 2 screwdriver, tighten the screw that secures the BOSS-N1 module blank to the system.

Next steps

Replace the BOSS-N1 module.

Installing the BOSS-N1 module

Prerequisites

1. Follow the safety guidelines listed in [Safety instructions](#).
2. Follow the procedure that is listed in [Before working inside your system](#) .
3. [Remove the air shroud](#).
4. If installed, [remove the front bezel](#).

Steps

1. Using a Phillips 2 screwdriver, remove the screw that secures the BOSS-N1 module blank from the system.
2. Slide out the BOSS-N1 module blank from the system using a flat head screwdriver.



Figure 68. Removing the BOSS-N1 module blank

3. Align the BOSS-N1 module to the BOSS-N1 slot on the chassis and push it into the slot.
4. Using a Phillips 2 screwdriver, secure the BOSS-N1 module to the system.

NOTE: The numbers on the image do not depict the exact steps. The numbers are for representation of sequence.

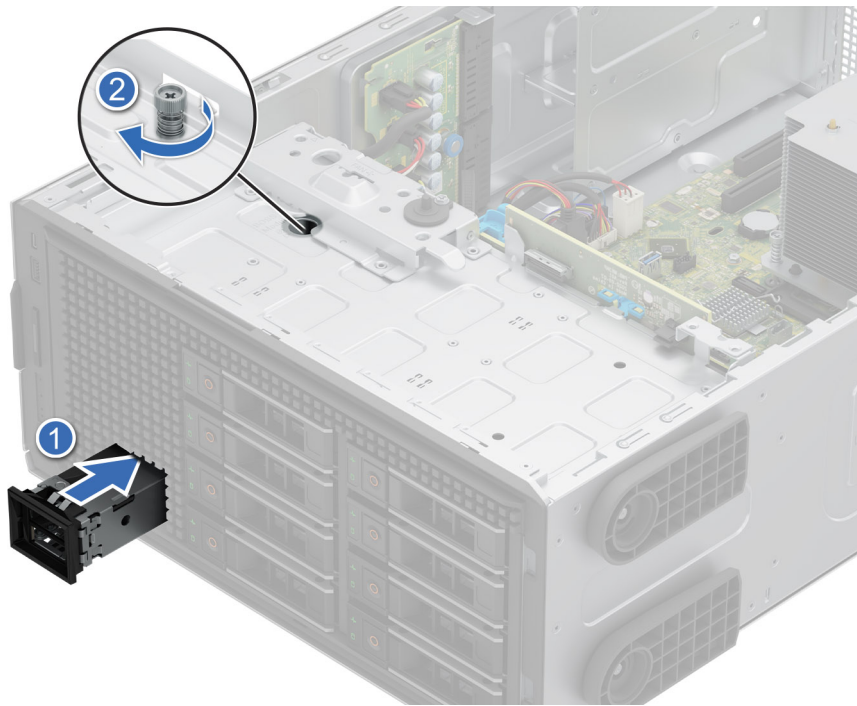

Figure 69. Installing the BOSS-N1 module

5. Connect the cables to the system board connectors.

NOTE: Route the cables properly to prevent them from being pinched or crimped.

Next steps

1. If removed, [install the front bezel](#).
2. [Install the air shroud](#).
3. Follow the procedure that is listed in [After working inside your system](#).

Removing the BOSS-N1 card carrier

Prerequisites

1. Follow the safety guidelines listed in [Safety instructions](#).
2. Follow the procedure that is listed in [Before working inside your system](#).
3. If installed, [remove the front bezel](#).

Steps

1. Open the release latch and slide the BOSS-N1 card carrier out of the BOSS-N1 module.



Figure 70. Removing the BOSS-N1 card carrier

2. Using the Phillips 1 screwdriver removes the M3 x 0.5 x 4.5 mm screw that secures the M.2 NVMe SSD to the BOSS-N1 card carrier.
3. Slide the M.2 NVMe SSD out from the BOSS-N1 card carrier.

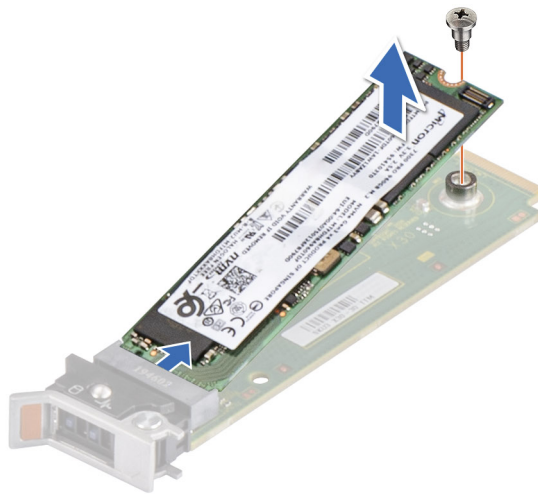

Figure 71. Removing the M.2 NVMe SSD

4. If not installing the BOSS-N1 card carrier, align and push the BOSS-N1 card carrier blank into the BOSS-N1 module to fill the empty BOSS-N1 card carrier slot.



Figure 72. Installing the BOSS-N1 card carrier blank

Next steps

[Replace the BOSS-N1 module](#)

Installing the BOSS-N1 card carrier

Prerequisites

1. Follow the safety guidelines listed in [Safety instructions](#) .
2. Follow the procedure that is listed in [.Before working inside your system](#)
3. If installed, [remove the front bezel](#).

Steps

1. Press the release clip and pull the BOSS-N1 card carrier blank out of the system.



Figure 73. Removing the BOSS-N1 card carrier blank

2. Align the M.2 NVMe SSD at an angle with the BOSS-N1 card carrier.
3. Insert the M.2 NVMe SSD until it is firmly seated in the BOSS-N1 card carrier.
4. Using the Phillips 1 screwdriver, secure the M.2 NVMe SSD on the BOSS-N1 card carrier with the M3 x 0.5 x 4.5 mm screw.

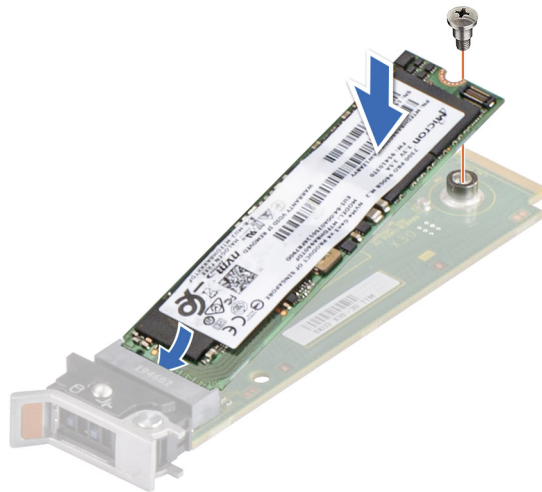

Figure 74. Installing the M.2 NVMe SSD

5. Align and push the BOSS-N1 card carrier into the slot in the BOSS-N1 module.
6. Close the release latch to secure the BOSS-N1 card carrier.



Figure 75. Installing the BOSS-N1 card carrier

Next steps

1. If removed, [install the front bezel](#).
2. Follow the procedure that is listed in [After working inside your system](#).

Power supply unit

NOTE: While replacing the hot swappable PSU, after next server boot; the new PSU automatically updates to the same firmware and configuration of the replaced one. For updating to the latest firmware and changing the configuration, see the *Lifecycle Controller User's Guide* at [iDRAC Manuals](#).

Hot spare feature

Your system supports the hot spare feature that significantly reduces the power overhead associated with the power supply unit (PSU) redundancy.

When the hot spare feature is enabled, one of the redundant PSUs is switched to the sleep state. The active PSU supports 100 percent of the system load, thus operating at higher efficiency. The PSU in the sleep state monitors output voltage of the active PSU. If the output voltage of the active PSU drops, the PSU in the sleep state returns to an active output state.

If having both PSUs active is more efficient than having one PSU in the sleep state, the active PSU can also activate the sleeping PSU.

The default PSU settings are as follows:

- If the load on the active PSU is more than 50 percent of PSU rated power wattage, then the redundant PSU is switched to the active state.
- If the load on the active PSU falls below 20 percent of PSU rated power wattage, then the redundant PSU is switched to the sleep state.

You can configure the hot spare feature by using the iDRAC settings. For more information, see the *iDRAC User's Guide* available at [PowerEdge Manuals](#).

Removing a power supply unit blank

Prerequisites

Follow the safety guidelines listed in the [Safety instructions](#).

Steps

Pull the blank out of the system.

CAUTION: For proper system cooling, the PSU blank must be installed in the second PSU bay in a non-redundant configuration. Remove the PSU blank only if you are installing a second PSU.

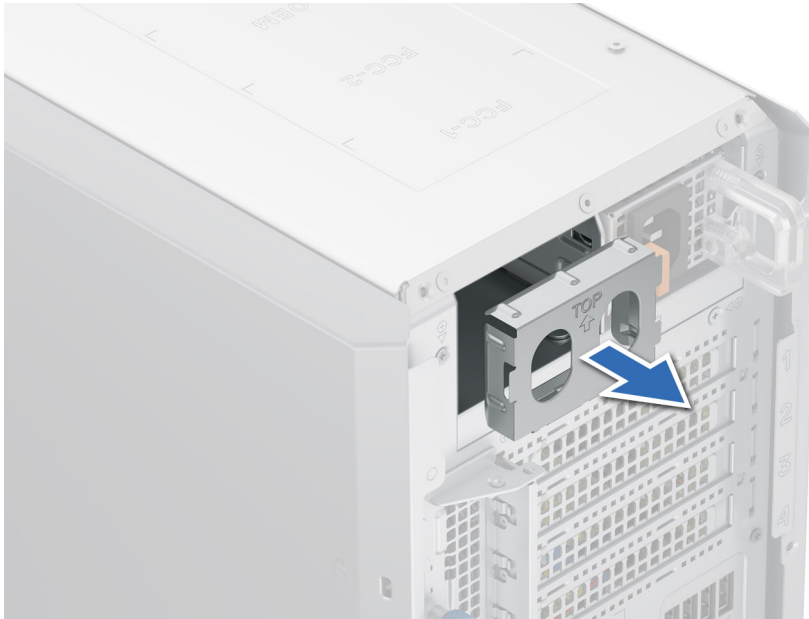

Figure 76. Removing a power supply unit blank

Next steps

Replace the [PSU blank](#) or [install the PSU](#).

Installing a power supply unit blank

Prerequisites

1. Follow the safety guidelines listed in the [Safety instructions](#).

NOTE: Install the power supply unit (PSU) blank only in the second PSU bay.

2. [Remove the PSU](#).

Steps

Align the PSU blank with the PSU bay and push it into the PSU bay until it clicks into place.



Figure 77. Installing a power supply unit blank

Removing a power supply unit

Prerequisites

CAUTION: The system requires one power supply unit (PSU) for normal operation. On power-redundant systems, remove and replace only one PSU at a time in a system that is powered on.

1. Follow the safety guidelines listed in the [Safety instructions](#).
2. Disconnect the power cable from the power outlet and from the PSU you intend to remove.
3. Remove the cable from the strap on the PSU handle.

Steps

Press the release latch, and holding the PSU handle slide the PSU out of the PSU bay.



Figure 78. Removing a power supply unit

Next steps

Replace the PSU or install the PSU blank.

Installing a power supply unit

Prerequisites

1. Follow the safety guidelines listed in the [Safety instructions](#).
2. For systems that support redundant PSU, ensure that both the PSUs are of the same type and have the same maximum output power.

NOTE: The maximum output power (shown in watts) is listed on the PSU label.

3. Remove the PSU blank.

Steps

Slide the PSU into the PSU bay until the release latch snaps into place.



Figure 79. Installing a power supply unit

Next steps

1. Connect the power cable to the PSU, and plug the cable into a power outlet.

CAUTION: When connecting the power cable to the PSU, secure the cable to the PSU with the strap.

NOTE: When installing, hot swapping, or hot adding a new PSU, wait for 15 seconds for the system to recognize the PSU and determine its status. The PSU redundancy may not occur until discovery is complete. The PSU status indicator turns green to indicate that the PSU is functioning properly.

NOTE: For certain premium configurations with high power consumption, the system PSU might stay with 2+0 mode only, 1+1 redundant mode is not available.

NOTE: While replacing the hot swappable PSU, after next server boot; the new PSU automatically updates to the same firmware and configuration of the replaced one. For updating to the latest firmware and changing the configuration, see the *Lifecycle Controller User's Guide* at [iDRAC Manuals](#).

Removing a cabled PSU

Prerequisites

1. Follow the safety guidelines listed in [Safety instructions](#).
2. Follow the procedure listed in [Before working inside your system](#).
3. Disconnect the power cables of the PSU from the system board and the drive backplane.
4. Remove the cables from the cable clip.

Steps

1. Using a Phillips 2 screwdriver, remove the screws that secure the PSU cage to the system.
2. Tilt at an angle and slide the PSU cage towards the front of the system.
3. Lift the PSU cage out of the system.

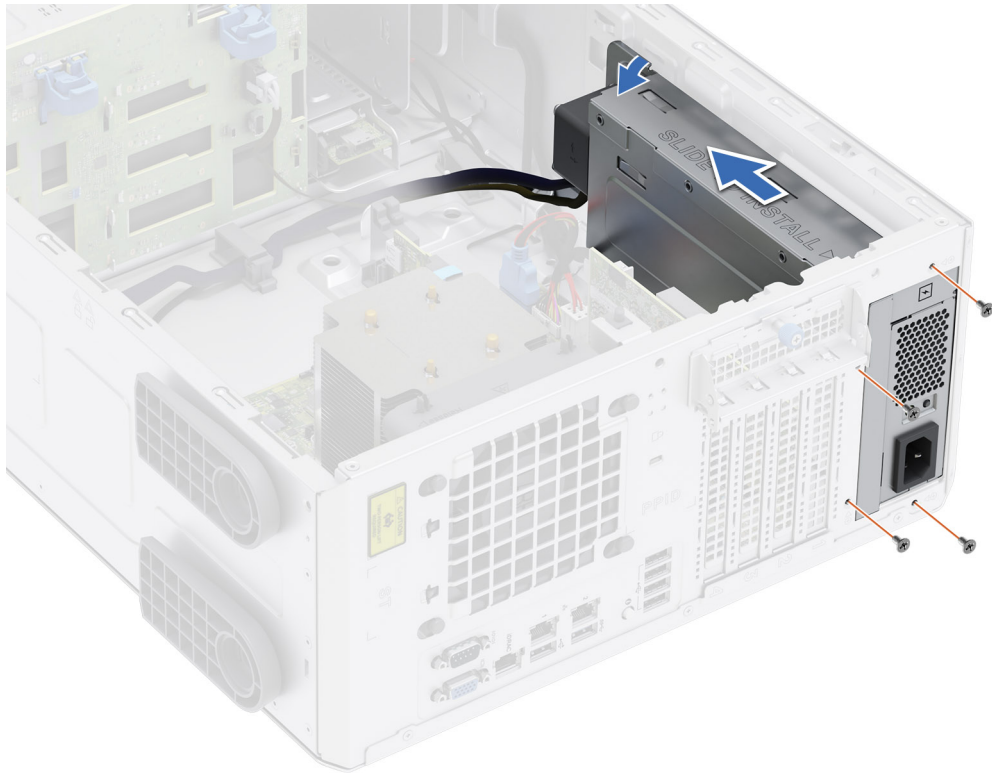

Figure 80. Removing the PSU cage

4. Using a Phillips 2 screwdriver, remove the screw that secures the PSU into PSU cage.
5. Slide the PSU out of the PSU cage.

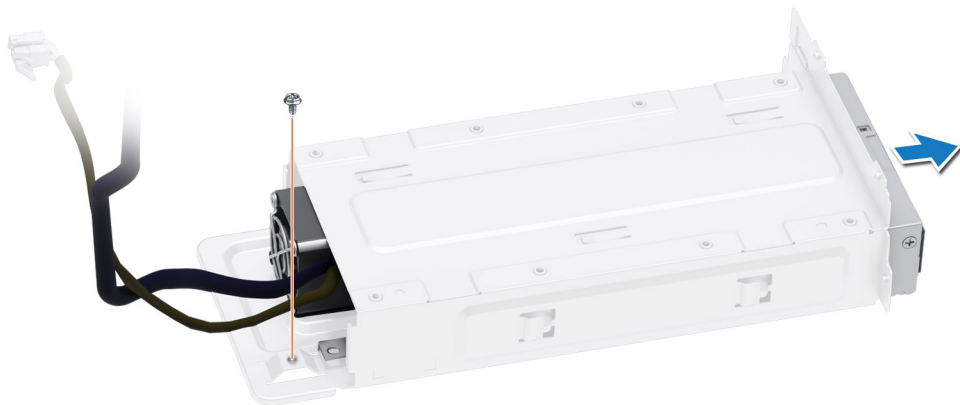

Figure 81. Removing the cabled PSU

Next steps

1. [Replace the cabled PSU.](#)

Installing the cabled PSU

Prerequisites

1. Follow the safety guidelines listed in [Safety instructions](#).
2. Unpack the replacement PSU.

Steps

1. Slide the PSU into the PSU cage and align with screw hole on the PSU cage.
2. Using the Phillips 2 screwdriver, tighten the screw that secures the PSU into PSU cage.

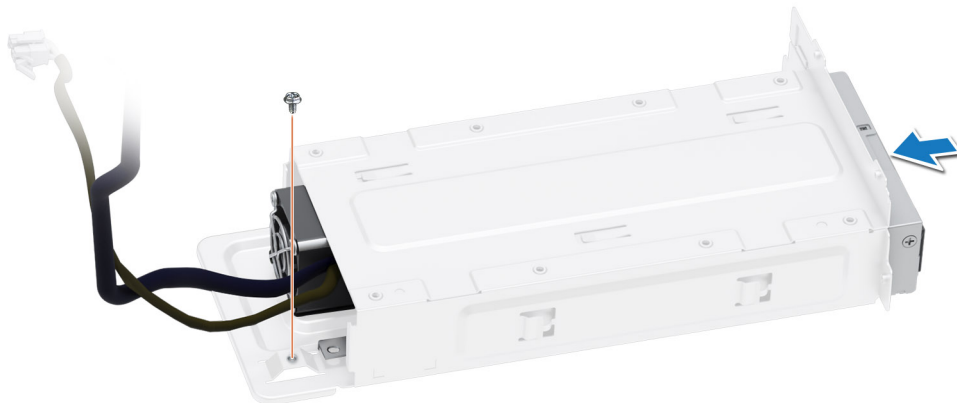

Figure 82. Installing the cabled PSU

3. Tilt at an angle and insert the PSU cage into the slots on the system then slide it towards the rear of the system until the PSU cage is fully seated.
4. Using the Phillips 2 screwdriver, tighten the screws that secure the PSU cage into the system.



Figure 83. Installing the PSU cage

Next steps

1. Connect all the power cables from the PSU to the system board and the drive backplane.
2. Route the power cables properly and secure them with cable clips.
3. Connect all the power cables from the PSU to the system board and the drive backplane.
4. Follow the procedure listed in [After working inside your system](#).

Power interposer board

This is a service technician replaceable part only.

Removing the power interposer board

Prerequisites

1. Follow the safety guidelines listed in [Safety instructions](#).
2. Follow the procedure that is listed in [Before working inside your system](#).
3. [Remove the air shroud](#).
4. [Remove the PSU](#).

Steps

1. Disconnect all the power cables from the PIB.
2. Using the Phillips 2 screwdriver, remove the screws that secure the PIB to the system.
3. Lift the PIB out of the system.



Figure 84. Removing the power interposer board

Next steps

Replace the power interposer board.

Installing the power interposer board

Prerequisites

1. Follow the safety guidelines listed in [Safety instructions](#).
2. Follow the procedure that is listed in [Before working inside your system](#).
3. [Remove the air shroud](#).
4. [Remove the PSU](#).

Steps

1. Align the screw holes on the power interposer board (PIB) with the holes on the system.
2. Using the Phillips 2 screwdriver, secure the PIB to the system using the screws.
3. Connect all the disconnected power cables to the PIB.



Figure 85. Installing the power interposer board

Next steps

1. [Install the PSUs.](#)
2. [Install the air shroud.](#)
3. Follow the procedure listed in [After working inside your system.](#)

System battery

This is a service technician replaceable part only.

Replacing the system battery

Prerequisites

⚠ WARNING: There is a danger of a new battery exploding if it is incorrectly installed. Replace the battery only with the same or equivalent type that is recommended by the manufacturer. Discard used batteries according to the manufacturer's instructions. See the Safety instructions that came with your system for more information.

1. Follow the safety guidelines listed in the [Safety instructions.](#)
2. Follow the procedure listed in the [Before working inside your system.](#)
3. If applicable, disconnect the power or data cables from the expansion cards.
4. [Remove the expansion cards.](#)

Steps

1. To remove the battery:
 - a. Press and hold the battery socket retention latch, for the battery to pop out.

i NOTE: If the battery does not pop out, then lift it out of the socket.

CAUTION: To avoid damage to the battery connector, you must firmly support the connector while installing or removing a battery.

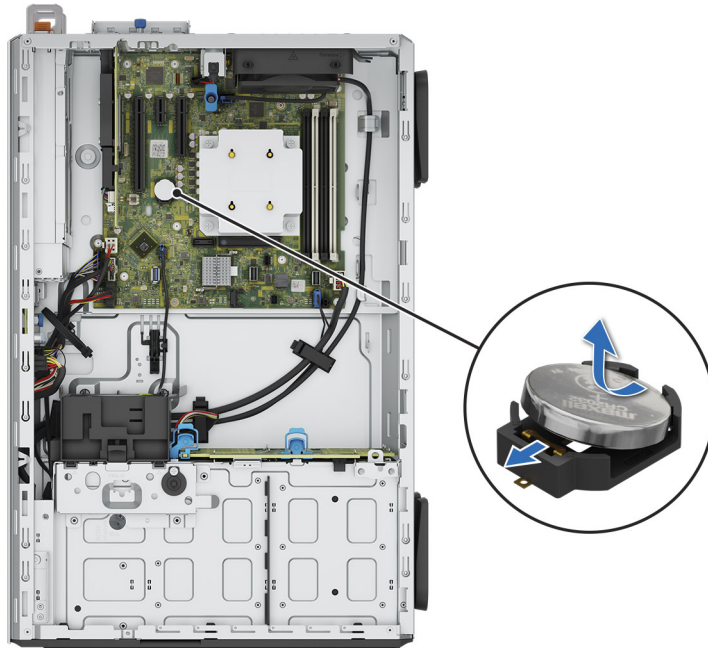

Figure 86. Removing the system battery

2. To install a new system battery:
 - a. Hold the battery with the positive side facing up and slide it under the securing tabs.
 - b. Press the battery into the connector until it snaps into place.

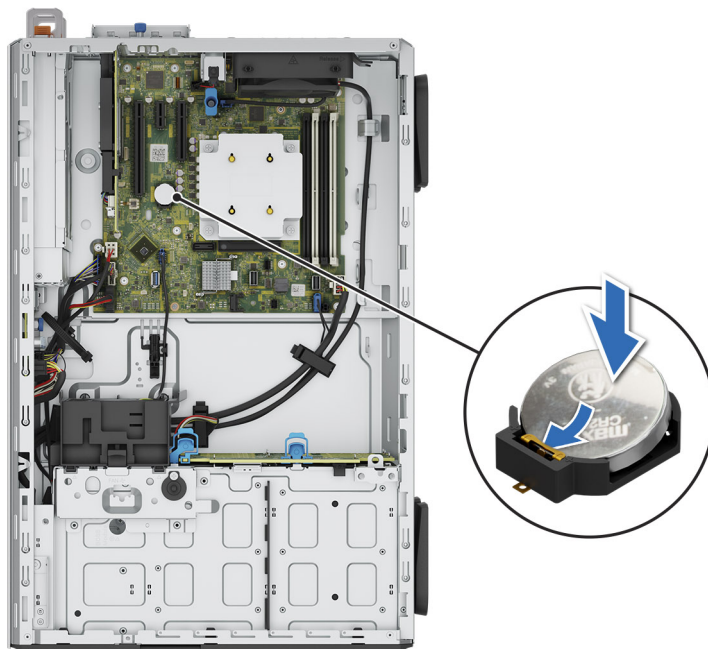

Figure 87. Installing the system battery

Next steps

1. [Install the expansion card risers.](#)
2. If applicable, connect the cables to one or more expansion cards.
3. Follow the procedure listed in [After working inside your system.](#)
4. Confirm that the battery is operating properly, by performing the following steps:
 - a. Enter the System Setup, while booting, by pressing F2.
 - b. Enter the correct time and date in the System Setup **Time** and **Date** fields.
 - c. **Exit** the System Setup.
 - d. To test the newly installed battery, check the time and date at least an hour after installing the battery.
 - e. Enter the System Setup and if the time and date are still incorrect, see [Getting help](#) section.

System board

This is a service technician replaceable part only.

Removing the system board

Prerequisites

 **CAUTION:** If you are using the Trusted Platform Module (TPM) with an encryption key, you may be prompted to create a recovery key during program or System Setup. Be sure to create and safely store this recovery key. If you replace this system board, you must supply the recovery key when you restart your system or program before you can access the encrypted data on your drives.

1. Follow the safety guidelines listed in the [Safety instructions.](#)
2. Follow the procedure listed in the [Before working inside your system.](#)
3. Remove the following components:
 - a. [Air shroud](#)
 - b. [Cooling fans](#)
 - c. [Memory modules](#)
 - d. [Expansion cards](#)
 - e. [Processor and heat sink module](#)
 - f. [Trusted Platform Module](#)
 - g. Disconnect all the cables from the system board and make note of all the cable connections.

 **CAUTION:** Take care not to damage the system identification button while removing the system board from the system.

 **CAUTION:** Do not lift the system board by holding a memory module, processor, or other components.

Steps

1. Using the system board holder and plunger, slide the system board towards the front of the system.
2. At a tilted angle, lift the system board out of the chassis.

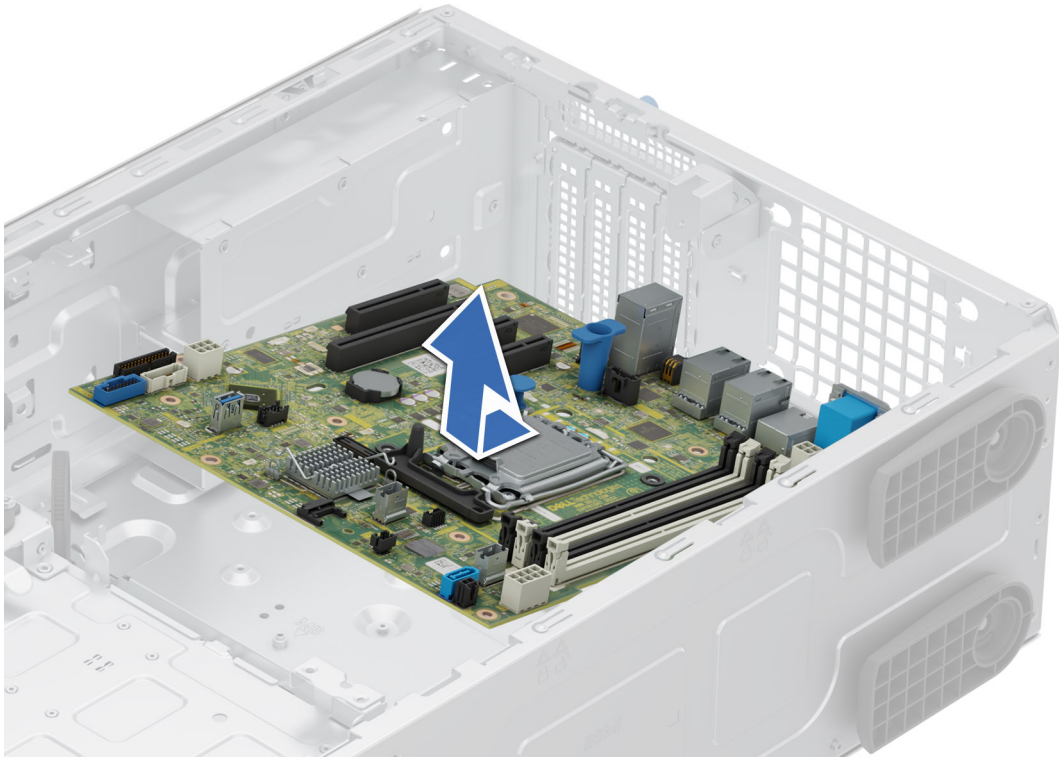

Figure 88. Removing the system board

Next steps

1. [Replace the system board.](#)

Installing the system board

Prerequisites

NOTE: Before replacing the system board, replace the old iDRAC MAC address label on the Express Service Tag with the iDRAC MAC address label of the replacement system board.

1. Follow the safety guidelines listed in the [Safety instructions](#).
2. Follow the procedure listed in [Before working inside your system](#).
3. If you are replacing the system board, remove all the components that are listed in the removing the system board section.

Steps

1. Unpack the new system board assembly.

CAUTION: Do not lift the system board by holding a memory module, processor, or other components.

CAUTION: Take care not to damage the system identification button while placing the system board into the chassis.

2. Holding the system board holder and plunger, lower the system board at a tilted angle into the system.
3. Slide the system board towards the rear of the chassis until the connectors are firmly seated in the slots.

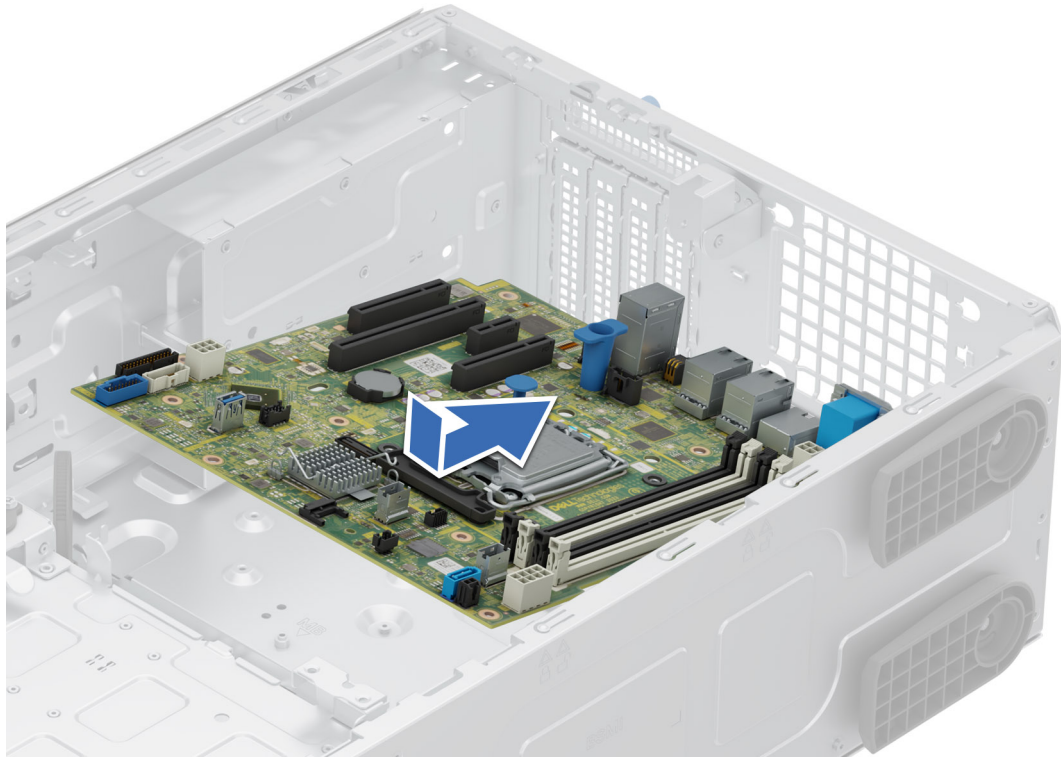

Figure 89. Installing the system board

Next steps

1. Replace the following components:
 - a. [Trusted Platform Module \(TPM\)](#)

i **NOTE:** The TPM Module must be replaced only while installing new system board.

- b. [Processor and heat sink module](#)
 - c. [Memory modules](#)
 - d. [Expansion cards](#)
 - e. [Cooling fans](#)
 - f. [Air shroud](#)
2. Reconnect all cables to the system board.

i **NOTE:** Ensure that the cables inside the system are routed along the chassis wall and secured using the cable securing bracket.

3. Ensure that you perform the following steps:
 - a. Use the Easy Restore feature to restore the Service Tag. See the [Restoring the system by using the Easy Restore feature](#) section.
 - b. If the service tag is not backed up in the backup flash device, enter the system service tag manually. See the [Manually update the Service Tag](#) by using System Setup section.
 - c. Update the BIOS and iDRAC versions.
 - d. Re-enable the Trusted Platform Module (TPM). See the [Upgrading the Trusted Platform Module](#) section.
4. Follow the procedure listed in [After working inside your system](#).

Restoring the system using Easy Restore

The Easy Restore feature enables you to restore your service tag, license, UEFI configuration, and the system configuration data after replacing the system board. All data is backed up in a backup flash device automatically. If BIOS detects a new system board, and the service tag in the backup flash device, BIOS prompts the user to restore the backup information.

About this task

Below is a list of options/steps available:

Steps

1. Restore the service tag, license, and diagnostics information, press **Y**
2. Navigate to the Lifecycle Controller based restore options, press **N**
3. Restore data from a previously created **Hardware Server Profile**, press **F10**

 **NOTE:** When the restore process is complete, BIOS prompts to restore the system configuration data.

4. Restore data from a previously created **Hardware Server Profile**, press **F10**
5. To restore the system configuration data, press **Y**
6. To use the default configuration settings, press **N**

 **NOTE:** After the restore process is complete, system reboots.

Manually update the Service Tag

After replacing a system board, if Easy Restore fails, follow this process to manually enter the Service Tag, using **System Setup**.

About this task

If you know the system service tag, use the **System Setup** menu to enter the service tag.

Steps

1. Power on the system.
2. To enter the **System Setup**, press **F2**.
3. Click **Service Tag Settings**.
4. Enter the service tag.

 **NOTE:** You can enter the service tag only when the **Service Tag** field is empty. Ensure that you enter the correct service tag. Once the service tag is entered, it cannot be updated or changed. Incorrectly entered service tag will lead to system board replacement.

5. Click **OK**.

Trusted Platform Module

This is a service technician replaceable part only.

Upgrading the Trusted Platform Module

Removing the TPM

Prerequisites

1. Follow the safety guidelines listed in the [Safety instructions](#).
2. Follow the procedure listed in [Before working inside your system](#).

 **NOTE:**

- Ensure the operating system is compatible with the TPM version you are installing.
- Ensure that you download and install the latest BIOS firmware on your system.
- Ensure that the BIOS is configured to enable UEFI boot mode.

CAUTION: The TPM plug-in module is cryptographically bound to that particular system board after it is installed. When the system is powered on, any attempt to remove an installed TPM plug-in module breaks the cryptographic binding, and the removed TPM cannot be installed on another system board. Ensure any keys you have stored on the TPM have been securely transferred.

Steps

1. Locate the TPM connector on the system board. For more information, see .
2. Press to hold the module down and remove the screw using the security Torx 8-bit shipped with the TPM module.
3. Slide the TPM module out from its connector.
4. Push the plastic rivet away from the TPM connector and rotate it 90° counterclockwise to release it from the system board.
5. Pull the plastic rivet out of its slot on the system board.

Installing the TPM

Prerequisites

1. Follow the safety guidelines listed in the [Safety instructions](#).
2. Follow the procedure listed in [Before working inside your system](#).

Steps

1. To install the TPM, align the edge connectors on the TPM with the slot on the TPM connector.
2. Insert the TPM into the TPM connector such that the plastic rivet aligns with the slot on the system board.
3. Press the plastic rivet until the rivet snaps into place.
4. Replace the screw that secures the TPM to the system board.

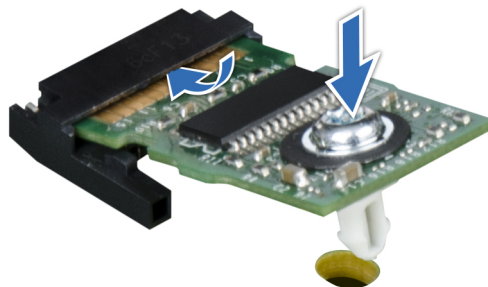

Figure 90. Installing the TPM

Initializing TPM for users

Steps

1. Initialize the TPM.
For more information, see [Initializing the TPM 2.0 for users](#).
2. The **TPM Status** changes to **Enabled, Activated**.

Initializing the TPM 2.0 for users

Steps

1. While booting your system, press F2 to enter System Setup.
2. On the **System Setup Main Menu** screen, click **System BIOS > System Security Settings**.

3. From the **TPM Security** option, select **On**.
4. Save the settings.
5. Restart your system.

Control panel

This is a service technician replaceable part only.

Removing the control panel assembly

Prerequisites

1. Follow the safety guidelines listed in [Safety instructions](#).
2. Follow the procedure listed in [Before working inside your system](#).
3. [Remove the front bezel](#).
4. Disconnect the control panel cable and the control panel USB cable from the connector system board.

 **NOTE:** Remove the control panel cables from the cable tie.

Steps

1. Using a Phillips 2 screwdriver, remove the screws that secure the system side cover to the chassis.
2. Tilt and slide the system side cover towards the rear of the system and remove the system side cover.



Figure 91. Removing the system side cover

3. Pull out the tabs on both sides of the front faceplate and remove the front faceplate out of the system.

i **NOTE:** For easy removal of tabs on the left side of the faceplate, it is recommended to use screwdriver or plastic scribe.



Figure 92. Removing the front faceplate

4. To remove control panel cage:
 - a. Press the side lever and slide out the control module cage from the system.
 - b. Disconnect the cable from the control panel assembly.



Figure 93. Removing the control panel cage

5. To remove control panel assembly:
 - a. Using a Phillips 2 screwdriver, remove the screws that secure the control panel assembly to the cage.
 - b. Slide out and remove the control panel assembly from the cage.

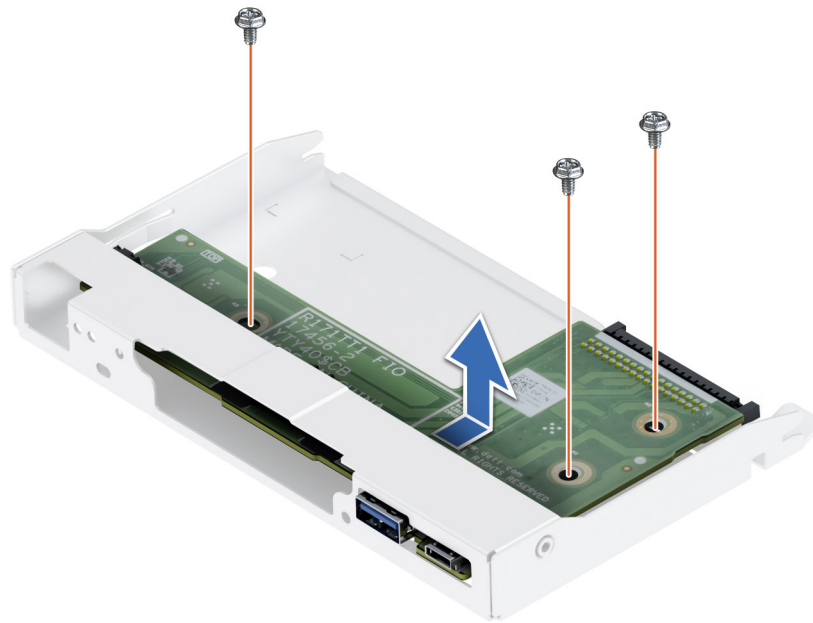

Figure 94. Removing the control panel assembly

Next steps

1. [Replace the control panel assembly.](#)

Installing the control panel assembly

Prerequisites

1. Follow the safety guidelines listed in [Safety instructions](#).
2. Follow the procedure listed in [Before working inside your system](#).
3. [Remove the front bezel.](#)

Steps

1. To install control panel assembly:
 - a. Align and slide the control panel assembly into the control panel cage.
 - b. Using a Phillips 2 screwdriver, tighten the screws that secure the control panel assembly to the cage.

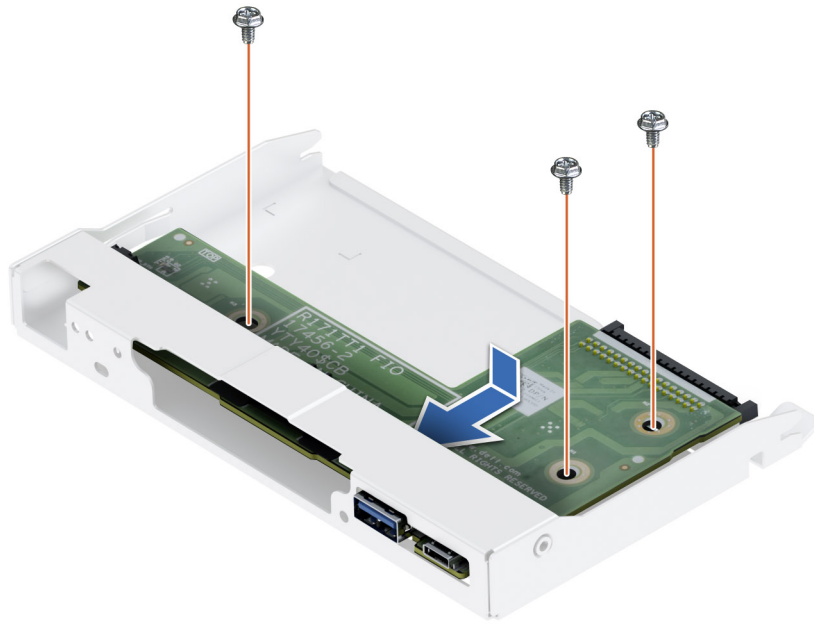

Figure 95. Installing the control panel assembly

2. To install control panel cage:
 - a. Connect the cable to the control panel assembly.
 - b. Slide the control panel cage into the system until clicks into its place.



Figure 96. Installing the control panel cage

3. Insert front faceplate tabs into the slots in the system and press until the front faceplate locks into place.



Figure 97. Installing the front faceplate

4. Tilt at an angle and align the system side cover with the slots in the system, then slide the cover towards the front of the system until locks into place.
5. Using a Phillips 2 screwdriver, tighten the screws that secure the system side cover to the chassis.



Figure 98. Installing the system side cover

Next steps

1. Connect the control panel cable and the control panel USB cable to the system board.

i **NOTE:** Secure the control panel cables with the cable tie to prevent it from being pinched or crimped.

2. Follow the procedure listed in [After working inside your system](#).

Upgrade Kits

The table lists the available After Point Of Sale [APOS] kits.

Table 65. Upgrade kits

Kits	Related links to service instructions
Memory modules	See Installing the memory module
SSDs	See Installing the SSDs
GPU	See Installing the GPU
Processors	See Installing the processor
Heat sink	See Installing the heat sink
Storage controller cards	See Installing the expansion card into the expansion card slots
HBA	
Network cards	
Power supplies	See Installing the power supply units
Cables	See Cable routing
Bezel	See Installing the bezel
Power cords	N/A
BOSS N1	See Installing an BOSS N1 module

Topics:

- [BOSS-N1 module kit](#)
- [GPU kit](#)
- [Filter bezel kit](#)

BOSS-N1 module kit

The BOSS-N1 module supports up to two M.2 NVMe SSDs.

Before you begin the installation or removal process, follow the [safety guidelines](#) and [before working inside the system](#) instructions.

Table 66. BOSS-N1 module kit components

Components in kit	T360 (quantity)
BOSS-N1 controller card module	1
BOSS-N1 card carrier	1 or 2*
M.2 NVMe SSD	1 or 2*
M.2 NVMe SSD capacity label	1 or 2†
BOSS-N1 card carrier blank	1
M3 x 0.5 x 4.5 mm screws	1
BOSS-N1 signal cable for mother board (360 mm)	1

Table 66. BOSS-N1 module kit components (continued)

Components in kit	T360 (quantity)
BOSS-N1 power cable for mother board (340 mm)	1

NOTE: *The quantity depends on the purchase order.

NOTE: †The quantity depends on the BOSS-N1 card carrier.

To remove the BOSS blank :

1. Power off the system.
2. Use a screwdriver to push out the blank from the BOSS-N1 module blank.



Figure 99. Removing the BOSS-N1 module blank

To install the BOSS blank:

1. Align the blank with the BOSS-N1 module bay and push it into the bay until it clicks into place.



Figure 100. Installing the BOSS-N1 module blank

To install the BOSS-N1 module:

1. To install the BOSS-N1 module, see [Installing the BOSS-N1 card carrier](#) steps 1 to 5.

i **NOTE:** Refer to [cable routing](#) section, configuration 49 and 50 for more information on connecting the BOSS cables to system board connectors.

i **NOTE:** Installing the BOSS-N1 card carrier does not require the system to be powered off. System shutdown is only required when installing the BOSS-N1 controller card module.

GPU kit

The GPU kit is available for the Customer. Depending on the kit ordered, the respective components are available.

CAUTION: Do not install GPUs, network cards, or other PCIe devices on your system that are not validated and tested by Dell. Damage caused by unauthorized and invalidated hardware installation will null and void the system warranty.

WARNING: Consumer-Grade GPU should not be installed or used in the Enterprise Server products.

Table 67. Components in the single width (SW) GPU kit

Components	GPU kit	
	Details	Quantity
Risers	Riser configuration (RC) 1 or 2	N/A
Shroud	PCI shroud	1
Fans	HPR PCI fan	1
Heat sinks	Standard or Performance heatsink based on the processor wattage	1
Cables	Power cable	NA

FL - Full Length, HL - Half Length, HPR - High Performance, RC - Riser configuration

NOTE: Adding GPUs to a system may increase the power envelope of that configuration beyond the current power supplies rated capability. Confirm power increase and upgrade PSU as needed to avoid negative impact on performance.

NOTE: See [expansion card installation guidelines](#) for more information about riser configuration supported for the system.

Before you begin, follow the [safety guidelines](#) and [before working inside the system](#) instructions.

1. [Remove the air shroud.](#)
2. Install the GPU, see [installing an expansion card](#).

NOTE: For information about riser slot location on the system board, see the [system board jumpers and connectors](#) section.

3. Install the High performance (HPR) PCI cooling fan.
4. If applicable, connect the power cables to the GPU. To know the connectors for the GPU on the system board, see the [system board jumpers and connectors](#) section.

See the GPU power cable matrix to know about the requirement of cables for the GPU.

NOTE: A maximum of one SW GPU is supported on the system.

After installing, follow the [After working inside the system](#) instructions.

Filter bezel kit

Prerequisites

The filter bezel kit and replacement filter media kit are available for the Customer. Depending on the kit ordered, the respective components are available.

Table 68. Components in the filter bezel kit

Components	Filter Bezel kit	
	Details	Quantity
Filter Bezel	Filter Bezel	1
Filter Media	Filter Media	1

Table 69. Components in the replacement filter media kit

Components	Filter Bezel kit	
	Details	Quantity
Filter Media	Filter Media	4

NOTE: To maintain optimal system health, Dell Technologies recommends checking and changing the filter media every 3-6 months. Filter media can be ordered from Dell.

Before you begin, follow the [safety guidelines](#) and [before working inside the system](#) instructions.

Steps

1. If installed [Remove the front bezel](#) and keep it safe.
2. Remove the bracket from the filter bezel.
3. Insert the filter media into the bracket.
4. Place the bracket into the filter bezel and secure it in place.
5. Align and insert the tabs on the bezel into the slots on the system.
6. Push the bezel toward the system until it locks into place.

NOTE: The numbers on the image do not depict the exact steps. The numbers are for representation of sequence.

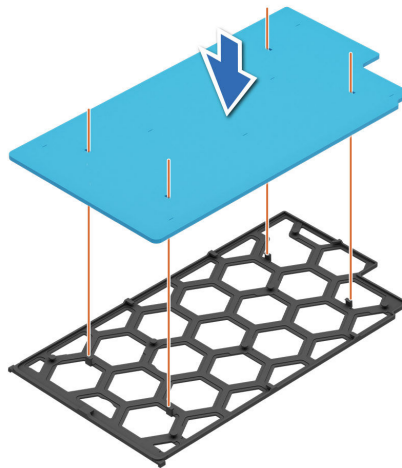

Figure 101. Installing the filter

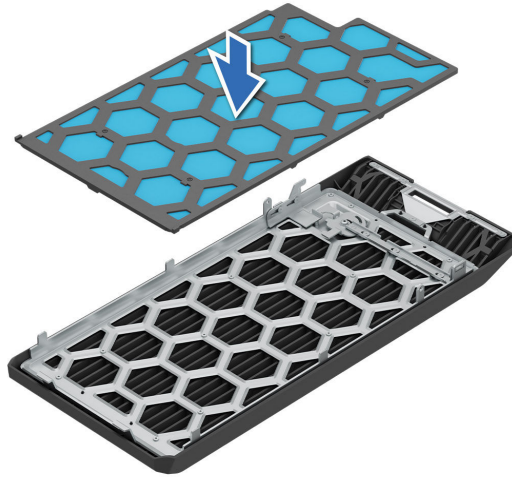

Figure 102. Installing the filter bezel

Next steps

After installing, follow the [After working inside the system](#) instructions.

Jumpers and connectors

This topic provides some basic and specific information about jumpers and switches. It also describes the connectors on the various boards in the system. Jumpers on the system board help to disable the system and reset the passwords. To install components and cables correctly, you must know the connectors on the system board.

Topics:

- [System board layout](#)
- [System board jumper settings](#)
- [Disabling a forgotten password](#)

System board layout

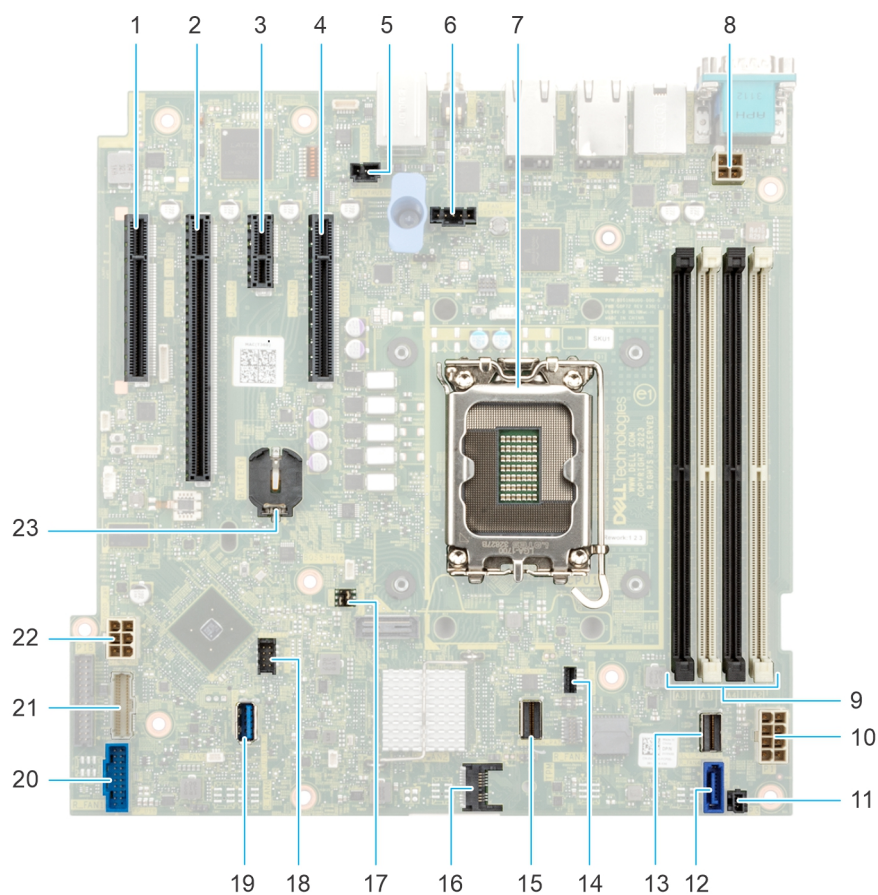

Figure 103. System board layout

Table 70. System board jumpers and connectors

Item	Connector	Description
1.	PCIe Slot 1 X4 (CPU)	PCIe card connector 1
2.	PCIe Slot 2 X16 (CPU)	PCIe card connector 2
3.	PCIe Slot 3 X1 (PCH)	PCIe card connector 3



Table 70. System board jumpers and connectors (continued)

Item	Connector	Description
4.	PCIe Slot 4 X4 (PCH)	PCIe card connector 4
5.	T_INTRUSION	Intrusion Switch Connector
6.	SYSTEM FAN	System cooling fan connector
7.	CPU	Processor socket
8.	PWR_CPU 1	CPU power connector P2
9.	A3, A1, A4, A2	Memory module sockets
10.	PWR_SYSTEM 1	System power connector P1
11.	PWR_EVENT1	Power event
12.	SATA_ODD/HDD Optical disk	Optical disk drive connector
13.	SL1 SATA X4	SATA connector
14.	BOSS_PWR	BOSS power connector
15.	SL2_PCH_PA2	BOSS signal connector
16.	TPM	Trusted platform module connector
17.	PWRD_EN and NVRAM_CLR	Jumper
18.	T_FAN 2	Fan Connector
19.	INT_USB1_3.0	Internal USB 3.0
20.	FP_USB	Front panel USB connector
21.	CTRL_PNL	Control panel
22.	HDD/ODD_POWER	Hard drive power connector
23.	BATTERY	CMOS Battery connector

System board jumper settings

For information about resetting the password jumper to disable a password, see the [Disabling a forgotten password](#) section.

Table 71. System board jumper settings

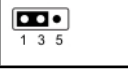
Jumper	Setting	Description
PWRD_EN	 2 4 6 (default)	The BIOS password feature is enabled.
	 2 4 6	The BIOS password feature is disabled. The BIOS password is now disabled and you are not allowed to set a new password.
NVRAM_CLR	 1 3 5 (default)	The BIOS configuration settings are retained at system boot.
	 1 3 5	The BIOS configuration settings are cleared at system boot.

CAUTION: You should be cautious when changing the BIOS settings. The BIOS interface is designed for advanced users. Any changes in the setting might prevent your system from starting correctly and may even result in data loss.



Disabling a forgotten password

The software security features of the system include a system password and a setup password. The password jumper enables or disables password features and clears any password(s) currently in use.

Prerequisites

 **CAUTION:** Many repairs may only be done by a certified service technician. You should only perform troubleshooting and simple repairs as authorized in your product documentation, or as directed by the online or telephone service and support team. Damage due to servicing that is not authorized by Dell is not covered by your warranty. Read and follow the safety instructions that are shipped with your product.

Steps

1. Power off the system and all attached peripherals. Disconnect the system from the electrical outlet, and disconnect the peripherals.
2. Remove the system cover.
3. Move the jumper on the system board from pins 2 and 4 to pins 4 and 6.
4. Replace the system cover.
 -  **NOTE:** The existing passwords are not disabled (erased) until the system boots with the jumper on pins 4 and 6. However, before you assign a new system and/or setup password, you must move the jumper back to pins 2 and 4.
 -  **NOTE:** If you assign a new system and/or setup password with the jumper on pins 4 and 6, the system disables the new password(s) the next time it boots.
5. Reconnect the peripherals and connect the system to the electrical outlet, and then power on the system.
6. Power off the system.
7. Remove the system cover.
8. Move the jumper on the system board from pins 4 and 6 to pins 2 and 4.
9. Replace the system cover.
10. Reconnect the peripherals and connect the system to the electrical outlet, and then power on the system.
11. Assign a new system and/or setup password.

System diagnostics and indicator codes

The diagnostic indicators on the system front panel display system status during system startup.

Topics:

- [System health and system ID indicator codes](#)
- [iDRAC Direct LED indicator codes](#)
- [NIC indicator codes](#)
- [Power supply unit indicator codes](#)
- [Drive indicator codes](#)
- [Using system diagnostics](#)

System health and system ID indicator codes

The system health and system ID indicator is located on the left control panel of the system.



Figure 104. System health and system ID indicator

Table 72. System health and system ID indicator codes

System health and system ID indicator code	Condition
Solid blue	Indicates that the system is powered on, is healthy, and system ID mode is not active. Press the system health and system ID button to switch to system ID mode.
Blinking blue	Indicates that the system ID mode is active. Press the system health and system ID button to switch to system health mode.
Solid amber	Indicates that the system is in fail-safe mode. If the problem persists, see the Getting help section.
Blinking amber	Indicates that the system is experiencing a fault. Check the System Event Log for specific error messages. For information about the event and error messages generated by the system firmware and agents that monitor system components, go to QRL > Look Up > Error Code , type the error code, and then click Look it up .

iDRAC Direct LED indicator codes

The iDRAC Direct LED indicator lights up to indicate that the port is connected and is being used as a part of the iDRAC subsystem.

You can configure iDRAC Direct by using a USB to micro USB (type AB) cable, which you can connect to your laptop or tablet. Cable length should not exceed 3 feet (0.91 meters). Performance could be affected by cable quality. The following table describes iDRAC Direct activity when the iDRAC Direct port is active:

Table 73. iDRAC Direct LED indicator codes

iDRAC Direct LED indicator code	Condition
Solid green for two seconds	Indicates that the laptop or tablet is connected.

Table 73. iDRAC Direct LED indicator codes (continued)

iDRAC Direct LED indicator code	Condition
Blinking green (on for two seconds and off for two seconds)	Indicates that the laptop or tablet connected is recognized.
LED Indicator off	Indicates that the laptop or tablet is unplugged.

NIC indicator codes

Each NIC on the back of the system has indicators that provide information about the activity and link status. The activity LED indicator indicates if data is flowing through the NIC, and the link LED indicator indicates the speed of the connected network.

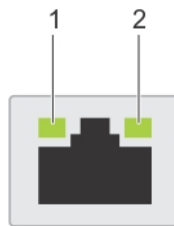

Figure 105. NIC indicator codes

1. Link LED indicator
2. Activity LED indicator

Table 74. NIC indicator codes

NIC indicator codes	Condition
Link and activity indicators are off.	Indicates that the NIC is not connected to the network.
Link indicator is green, and activity indicator is blinking green.	Indicates that the NIC is connected to a valid network at its maximum port speed, and data is being sent or received.
Link indicator is amber, and activity indicator is blinking green.	Indicates that the NIC is connected to a valid network at less than its maximum port speed, and data is being sent or received.
Link indicator is green, and activity indicator is off.	Indicates that the NIC is connected to a valid network at its maximum port speed, and data is not being sent or received.
Link indicator is amber, and activity indicator is off.	Indicates that the NIC is connected to a valid network at less than its maximum port speed, and data is not being sent or received.
Link indicator is blinking green, and activity is off.	Indicates that the NIC identity is enabled through the NIC configuration utility.

Power supply unit indicator codes

AC and DC power supply units (PSUs) have an illuminated translucent handle that serves as an indicator. The indicator shows if power is present or if a power fault has occurred.

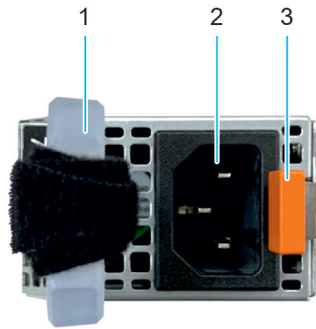

Figure 106. AC PSU status indicator

1. AC PSU handle
2. Socket
3. Release latch

Table 75. AC and DC PSU status indicator codes

Power indicator codes	Condition
Green	Indicates that a valid power source is connected to the PSU and the PSU is operational.
Blinking amber	Indicates an issue with the PSU.
Not powered on	Indicates that the power is not connected to the PSU.
Blinking green	Indicates that the firmware of the PSU is being updated. ⚠ CAUTION: Do not disconnect the power cord or unplug the PSU when updating firmware. If the firmware update is interrupted, the PSUs will not function.
Blinking greens and powers off	When hot-plugging a PSU, it blinks green five times at a rate of 4 Hz and powers off. This indicates a PSU mismatch due to efficiency, feature set, health status, or supported voltage. ⚠ CAUTION: If two PSUs are installed, both the PSUs must have the same type of label; for example, Extended Power Performance (EPP) label. Mixing PSUs from previous generations of PowerEdge servers is not supported, even if the PSUs have the same power rating. This results in a PSU mismatch condition or failure to power on the system. ⚠ CAUTION: If two PSUs are used, they must be of the same type and have the same maximum output power. ⚠ CAUTION: When correcting a PSU mismatch, replace the PSU with the blinking indicator. Swapping the PSU to make a matched pair can result in an error condition and an unexpected system shutdown. To change from a high output configuration to a low output configuration or vice versa, you must power off the system. ⚠ CAUTION: AC PSUs support both 240 V and 120 V input voltages except for Titanium PSUs, which support only 240 V. When two identical PSUs receive different input voltages, they can output different wattages, and trigger a mismatch.

Drive indicator codes

The LEDs on the drive carrier indicate the state of each drive. Each drive carrier has two LEDs: an activity LED (green) and a status LED (bicolor, green/amber). The activity LED blinks whenever the drive is accessed.

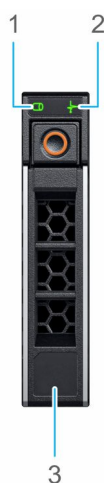

Figure 107. Drive indicators

1. Drive activity LED indicator
2. Drive status LED indicator
3. Drive capacity label

NOTE: If the drive is in the Advanced Host Controller Interface (AHCI) mode, the status LED indicator does not power on.

NOTE: Drive status indicator behavior is managed by Storage Spaces Direct. Not all drive status indicators may be used.

Table 76. Drive indicator codes

Drive status indicator code	Condition
Blinks green twice per second	Indicates that the drive is being identified or preparing for removal.
Not powered on	Indicates that the drive is ready for removal. NOTE: The drive status indicator remains off until all drives are initialized after the system is powered on. Drives are not ready for removal during this time.
Blinks green, amber, and then powers off	Indicates that there is an unexpected drive failure.
Blinks amber four times per second	Indicates that the drive has failed.
Blinks green slowly	Indicates that the drive is rebuilding.
Solid green	Indicates that the drive is online.
Blinks green for three seconds, amber for three seconds, and then powers off after six seconds	Indicates that the rebuild has stopped.

Using system diagnostics

If you experience an issue with the system, run the system diagnostics before contacting Dell for technical assistance. The purpose of running system diagnostics is to test the system hardware without using additional equipment or risking data loss. If you are unable to fix the issue yourself, service and support personnel can use the diagnostics results to help you solve the issue.

Dell Embedded System Diagnostics

NOTE: The Dell Embedded System Diagnostics is also known as Enhanced Pre-boot System Assessment (ePSA) diagnostics.

The Embedded System Diagnostics provide a set of options for particular device groups or devices allowing you to:

- Run tests automatically or in an interactive mode
- Repeat tests
- Display or save test results
- Run thorough tests to introduce additional test options to provide extra information about the failed device(s)
- View status messages that inform you if tests are completed successfully
- View error messages that inform you of issues encountered during testing

Running the Embedded System Diagnostics from Boot Manager

Run the Embedded System Diagnostics (ePSA) if your system does not boot.

Steps

1. When the system is booting, press F11.
2. Use the up arrow and down arrow keys to select **System Utilities > Launch Diagnostics**.
3. Alternatively, when the system is booting, press F10, select **Hardware Diagnostics > Run Hardware Diagnostics**.
The **ePSA Pre-boot System Assessment** window is displayed, listing all devices detected in the system. The diagnostics starts executing the tests on all the detected devices.

Running the Embedded System Diagnostics from the Dell Lifecycle Controller

Steps

1. When the system is booting, press F10.
2. Select **Hardware Diagnostics → Run Hardware Diagnostics**.
The **ePSA Pre-boot System Assessment** window is displayed, listing all devices detected in the system. The diagnostics start executing the tests on all the detected devices.

System diagnostic controls

Table 77. System diagnostic controls

Menu	Description
Configuration	Displays the configuration and status information of all detected devices.
Results	Displays the results of all tests that are run.
System health	Provides the current overview of the system performance.
Event log	Displays a time-stamped log of the results of all tests run on the system. This is displayed if at least one event description is recorded.

System board diagnostic LED indicators

The system board LED indicators provide status of the system when it is powered on, which help identify POST and hardware issues.

The following tables show the behavior system board diagnostic LED indicators during power sequencing and power faults.

Table 78. Legend



LED status	
LED ON	
LED OFF	
Blink	B

Table 79. System board diagnostic LED indicators during power sequencing





















LED 6	LED 5	LED 4	LED 3	LED 2	LED 1	LED 0	Description
							IDLE : System waiting for PS1/2_AC_OK or (CARDEDGE_CABLE_PRESENT_N = 0)
							S6_IDLE : Waiting for ((PS1/2_PG and PS1/2_Enable) or (CARDEDGE_CABLE_PRESENT_N = 0 and PWRGD_PS_PWROK)) and ((BmcPostReady and PsUpdateInProgress = 0) or BmcBootFirstEnable = 0), if cVACRequest then KULL_AUX
							S5_STATE2 : Waiting for PCH_SLP_SUS_NS5

Table 79. System board diagnostic LED indicators during power sequencing (continued)

LED 6	LED 5	LED 4	LED 3	LED 2	LED 1	LED 0	Description
							S5_STATE3 : Waiting for VRD_0P82_P CH_PG
							S5_STATE4 : Waiting for VRD_1P05_P CH_PG
							S5_STATE5 : Waiting for PCH_R SMRST_N
							S5_IDLE : Waiting for PCH_SLP_S5 _N if cVACRequest then KULL_AUX if c12vMainPwr Dn then KULL_MAIN if c12vMainPwr Dn then KULL_MAIN
							S0_STATE0 : Waiting for BmcHoldSysIn S5 = 0 and PCH_SLP_S3 _N and CpuConfigGo od Allen: replaced by PCH_SLP_S3 _N, PCH_PWR_O N_REQ as unused pin

Table 79. System board diagnostic LED indicators during power sequencing (continued)

LED 6	LED 5	LED 4	LED 3	LED 2	LED 1	LED 0	Description
							S0_STATE1 : Waiting for (PS1/2_AC_ OK or (CARDEdge_ CABLE_PRES _N = 0 and PWRGD_PS_ PWRO K)) and VRD_3P3_M AIN_PGand VRD_1P1_MAI N_PG and VRD_P5V_P Gand BP_PG
							S0_STATE2 : Waiting for VRD_PVCC1V 05_CPU_PG
							S0_STATE3 : Waiting for VRD_PVCCD D2_CPU_PG
							S0_STATE4 : Waiting for VRD_PVCCIN _AUX_PG
							S0_STATE5 : Waiting for VRD_PVCC1P 8_CPU_PG
							S0_STATE6 : Waiting for VRD_PVCC_ CORE_PG
							S0_RUN: System Run

Table 79. System board diagnostic LED indicators during power sequencing (continued)





















LED 6	LED 5	LED 4	LED 3	LED 2	LED 1	LED 0	Description
							if (SdpmBmcAllowPmArm and SdpmMode and SdpmHostReqPmArm) then RUN_SDPM_ARMED if CpsPmArmed then RUN_CPS_ARMED
							PD_INIT: if PCH_SLP_S3_N = 0 or DelayedCpuPpg = 0 then PD_STATE1 if cTotalDcLossFlag then SPD_STATE1, if cDpuPwrDownGate then DPU_PD_STATE1
							PD_IDLE: if PCH_SLP_S5_N = 0 and then S5_IDLE, if cTotalDcLossFlag = 1 then SPD_STATE1 if cAnyPwrFault = 1 and cAnyMempFault = 0 then KULL_MAIN, if cAnyMempFault = 1 then DIMM_PFAULT
							SPD_STATE2 : Waiting for CombinedCpuPgs (VRD_3P3_MAIN_PGand VRD_PVCC_

Table 79. System board diagnostic LED indicators during power sequencing (continued)

























































LED 6	LED 5	LED 4	LED 3	LED 2	LED 1	LED 0	Description
							CORE_PG and PCH_CPLD_PROCPWRGD) = 0
							SPD_IDLE: Waiting for TotalPowerLossFlag = 0 or TotalDCLossFlag = 0 or PfaultFlag = 0
							VAC: Waiting forever
							<p>KULL_MAIN : if cAuxPGpFault = 1and Waitingfor7se condsthen AUX_FAILSA FE,ifcAuxPGp Fault=0and cMainPGpFau lt=1andcMain Failsafe=1and Waitingfor7se conds then MAIN_FAILSA FE,ifcAuxPGp Fault=0andc MainPGpFault =1and cMainFailsafe =0and Waitingfor7se condsthen PFAULT</p> <p>if cAuxPGpFault = 0and cMainPGpFau lt=0and</p> <p>Waitingfor7se condsthenS6 _IDLE</p>
							PFAULT: if cPfaultFlag = 0 and cMainPGpFault = 0 and cAnyPwrFault

Table 79. System board diagnostic LED indicators during power sequencing (continued)

LED 6	LED 5	LED 4	LED 3	LED 2	LED 1	LED 0	Description
							= 0 then S6_IDLE
							MAIN_FAILSAFE: if cMainFailsafeFlag = 0 and cMainFailsafe = 0 and cAnyPwrFault = 0 then S6_IDLE
							AUX_FAILSAFE: Waiting forever
							DIM M_PFAULT: if cAuxPGpFault then KULL_MAIN, if cTotalDcLossFlag then SPD_STATE1 if (cMainFailsafeFlag = 0 and cMainFailsafe = 0 and cAnyPwrFault = 0 and wait for 7 seconds) then S5_IDLE
							DPU_PD_STATE1: Waiting for Total DCLossF lag

NOTE: At S6_STATE1~ S0_RUN and RUN_SDPM_ARMED when PCH_SLP_S3_N from 1 to 0 (PowerDownRequest) then go to state PD_INIT

Table 80. System board diagnostic LED indicators during power faults































































LED 6	LED 5	LED 4	LED 3	LED 2	LED 1	LED 0	Description
						B	VRD_0P82_PCHFault
					B		VRD_1P05_PCHFault
					B	B	VRD_1V175_SWFault

Table 80. System board diagnostic LED indicators during power faults (continued)

LED 6	LED 5	LED 4	LED 3	LED 2	LED 1	LED 0	Description
				B	B		VRD_P5VFault
				B			VRD_3P3_MAINFault
						B	VRD_1P1_MAINFault
		B					VRD_PVCC1V05_CPUFault
		B			B		VRD_PVCCD2_CPUFault
		B		B			VRD_PVCCIN_AUXFault
		B		B	B		VRD_PVCC1P8_CPUFault
		B	B				VRD_PVCC_COREFault
B	B	B					Cabled PSU Fault

Getting help

Topics:

- [Recycling or End-of-Life service information](#)
- [Contacting Dell Technologies](#)
- [Accessing system information by using QRL](#)
- [Receiving automated support with Secure Connect Gateway \(SCG\)](#)

Recycling or End-of-Life service information

Take back and recycling services are offered for this product in certain countries. If you want to dispose of system components, visit [How to Recycle](#) and select the relevant country.

Contacting Dell Technologies

Dell provides online and telephone based support and service options. If you do not have an active internet connection, you can find Dell contact information on your purchase invoice, packing slip, bill or Dell product catalog. The availability of services varies depending on the country and product, and some services may not be available in your area. To contact Dell for sales, technical assistance, or customer service issues follow these steps:

Steps

1. Go to [Dell Support](#).
2. Select your country from the drop-down menu on the lower right corner of the page.
3. For customized support:
 - a. Enter the system Service Tag in the **Enter a Service Tag, Serial Number, Service Request, Model, or Keyword** field.
 - b. Click **Search**.
The support page that lists the various support categories is displayed.
4. For general support:
 - a. Select your product category.
 - b. Select your product segment.
 - c. Select your product.
The support page that lists the various support categories is displayed.
5. For contact details of Dell Global Technical Support:
 - a. Click [Contact Technical Support](#).
 - b. The **Contact Technical Support** page is displayed with details to call, chat, or e-mail the Dell Global Technical Support team.

Accessing system information by using QRL

There is also another QRL for accessing product information on the back of the system cover.

Prerequisites

Ensure that your smartphone or tablet has a QR code scanner installed.

The QRL includes the following information about your system:

- How-to videos

- Reference materials, including the Installation and Service Manual, and mechanical overview
- The system service tag to quickly access the specific hardware configuration and warranty information
- A direct link to Dell to contact technical assistance and sales teams

Steps

1. Go to [qrl](#), and navigate to your specific product or
2. Use your smart phone or tablet to scan the model-specific Quick Resource (QR) code on your system or in the Quick Resource Locator section.

Quick Resource Locator for PowerEdge T360 system

Receiving automated support with Secure Connect Gateway (SCG)

Dell Secure Connect Gateway (SCG) is an optional Dell Services offering that automates technical support for your Dell server, storage, and networking devices. By installing and setting up a Secure Connect Gateway (SCG) application in your IT environment, you can receive the following benefits:

- Automated issue detection — Secure Connect Gateway (SCG) monitors your Dell devices and automatically detects hardware issues, both proactively and predictively.
- Automated case creation — When an issue is detected, Secure Connect Gateway (SCG) automatically opens a support case with Dell Technical Support.
- Automated diagnostic collection — Secure Connect Gateway (SCG) automatically collects system state information from your devices and uploads it securely to Dell. This information is used by Dell Technical Support to troubleshoot the issue.
- Proactive contact — A Dell Technical Support agent contacts you about the support case and helps you resolve the issue.

The available benefits vary depending on the Dell Service entitlement purchased for your device. For more information about Secure Connect Gateway (SCG), go to [secureconnectgateway](#).

Documentation resources

This section provides information about the documentation resources for your system.

To view the document that is listed in the documentation resources table:

- From the Dell support site:
 1. Click the documentation link that is provided in the Location column in the table.
 2. Click the required product or product version.

 **NOTE:** To locate the model number, see the front of your system.

3. On the Product Support page, click **Documentation**.
- Using search engines:
 - Type the name and version of the document in the search box.

Table 81. Additional documentation resources for your system

Task	Document	Location
Setting up your system	For information about setting up your system, see the <i>Getting Started Guide</i> document that is shipped with your system.	PowerEdge Manuals
Configuring your system	For information about the iDRAC features, configuring and logging in to iDRAC, and managing your system remotely, see the Integrated Dell Remote Access Controller User's Guide.	PowerEdge Manuals
	For information about understanding Remote Access Controller Admin (RACADM) subcommands and supported RACADM interfaces, see the RACADM CLI Guide for iDRAC.	
	For information about Redfish and its protocol, supported schema, and Redfish Eventing implemented in iDRAC, see the Redfish API Guide.	
	For information about iDRAC property database group and object descriptions, see the Attribute Registry Guide.	iDRAC Manuals
	For information about Intel QuickAssist Technology, see the Integrated Dell Remote Access Controller User's Guide.	
	For information about earlier versions of, the iDRAC documents.	
	To identify the version of iDRAC available on your system, on the iDRAC web interface, click ? > About .	
	For information about installing the operating system, see the operating system documentation.	Operating System Manuals

Table 81. Additional documentation resources for your system (continued)

Task	Document	Location
	For information about updating drivers and firmware, see the Methods to download firmware and drivers section in this document.	Drivers
Managing your system	For information about systems management software offered by Dell, see the Dell OpenManage Systems Management Overview Guide.	PowerEdge Manuals
	For information about setting up, using, and troubleshooting OpenManage, see the Dell OpenManage Server Administrator User's Guide.	OpenManage Manuals
	For information about installing and using Dell Secure Connect Gateway, see the Dell Secure Connect Gateway Enterprise User's Guide.	serviceability tools
	For information about partner programs enterprise systems management, see the OpenManage Connections Enterprise Systems Management documents.	OpenManage Manuals
Working with the Dell PowerEdge RAID controllers (if applicable)	For information about understanding the features of the Dell PowerEdge RAID controllers (PERC), Software RAID controllers, or BOSS card and deploying the cards, see the Storage controller documentation.	Storage Controller Manuals
Understanding event and error messages	For information about the event and error messages generated by the system firmware and agents that monitor system components, go to QRL > Look Up > Error Code , type the error code, and then click Look it up .	QRL
Troubleshooting your system	For information about identifying and troubleshooting the PowerEdge server issues, see the Server Troubleshooting Guide.	PowerEdge Manuals