

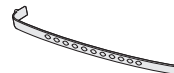

LED TV
43/50/55/65US662H*
43/50/55US665H*

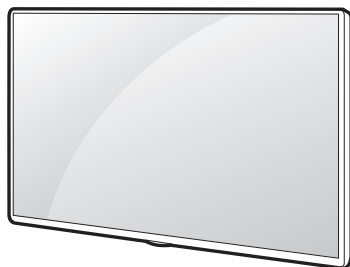

▶ www.lg.com/id-manual



⊕ : Depending on model / В зависимости от модели / Závísí na modelu / Selon le modèle / Abhängig vom Modell / Ανάλογα με το μοντέλο /
Típusfüggő / In base al modello / Zależnie od modelu / Dependendo do modelo / În funcție de model / U zavisnosti od modela /
Ovisno o modelu / Odvisno od modela / En función del modelo



English

- Read **Safety and Reference**.
- You can download more detailed information on our website by entering the full model number.
- For the power supply and power consumption, refer to the label attached to the product.

Български

- Прочетете **Безопасност и справка**.
- Можете да свалите по-подробна информация на нашия уебсайт като въведете целия номер на модела.
- Направете справка с етикета на продукта за електрозахранването и консумацията на енергия.

Français

- Lire le document **Sécurité et référence**.
- Vous pouvez télécharger des informations plus détaillées sur notre site Web en saisissant la référence complète du modèle.
- Reportez-vous à l'étiquette apposée sur le téléviseur pour connaître l'alimentation et la consommation électriques.

Ελληνικά

- Ανάγνωση **Ασφάλεια και αναφορά**.
- Μπορείτε να κατεβάσετε πιο αναλυτικές πληροφορίες από τη διαδικτυακή τοποθεσία μας συμπληρώνοντας τον πλήρη αριθμό μοντέλου.
- Για πληροφορίες σχετικά με την τροφοδοσία και την κατανάλωση ενέργειας, δείτε την ετικέτα του προϊόντος.

Italiano

- Consultare la sezione **Sicurezza e informazioni di riferimento**.
- È possibile scaricare informazioni più dettagliate sul sito Web inserendo il numero completo del modello.
- Per l'alimentazione e il consumo di energia, consultare l'etichetta applicata sul prodotto.

Português

- Consulte o manual de **Segurança e Referência**.
- Pode transferir informações mais detalhadas no nosso site ao introduzir o número completo do modelo.
- No que respeita à fonte de alimentação e ao consumo de energia, consulte a etiqueta mostrada no produto.

Česky

- Přečtěte si část **Bezpečnost a reference**.
- Podrobnější informace si můžete stáhnout z našich webových stránek po zadáním kompletního čísla modelu.
- Informace o napájení a příkonu naleznete na štítku připevněném k výrobku.

Deutsch

- **Sicherheitshinweise und Referenzen:** Bitte lesen!
- Genauer Informationen können Sie von unserer Webseite herunterladen, indem Sie die vollständige Modellnummer eingeben.
- Informationen zur Stromversorgung und zum Stromverbrauch sind dem Etikett auf dem Gerät zu entnehmen.

Magyar

- Lásd: **Biztonsági óvintézkedések**.
- A teljes modellszám megadásával letölthet részletesebb információkat a weboldalunkról.
- A tápellátásra és az áramfogyasztásra vonatkozó adatok a készülékre ragasztott címkén találhatóak.

Polski

- Przeczytaj **Zasady bezpieczeństwa i informacje dodatkowe**.
- Bardziej szczegółowe informacje można pobrać z naszej strony internetowej po wprowadzeniu pełnego numeru modelu.
- Dokładne informacje o zasilaniu i zużyciu energii są umieszczone na etykietach znajdujących się na produkcie.

Română

- Citiți **Siguranță și referințe**.
- Puteți să descărcați informații mai detaliate de pe site-ul nostru web, introducând numărul complet al modelului.
- Pentru sursa de alimentare și consumul de energie, consultați eticheta atașată pe produs.

Srpski

- Pročitajte **Bezbednost i informacije**.
- Detaljnije informacije možete da preuzmete na našem web-sajtu unosom celog broja modela.
- Da biste saznali informacije u vezi sa napajanjem i potrošnjom energije, pogledajte oznaku na proizvodu.



Hrvatski

- Pročitajte **Sigurnost i reference**.
- Možete preuzeti detaljnije informacije na našoj web stranici tako da unesete cijeli broj modela.
- Informacije o napajanju i potrošnji energije potražite na oznaci koja se nalazi na proizvodu.

Español

- Leer **Seguridad y Referencias**.
- Puede descargar información más detallada desde nuestro sitio web introduciendo el número de modelo completo.
- Para obtener información acerca de la fuente de alimentación y el consumo de energía, consulte la etiqueta del producto.

Slovenščina

- Preberite **Varnostne informacije in napotki**.
- Bolj podrobne informacije lahko prenesete z našega spletnega mesta, tako da vnesete celotno številko modela.
- Podatke o napajanju in porabi energije si oglejte na nalepki izdelka.



1

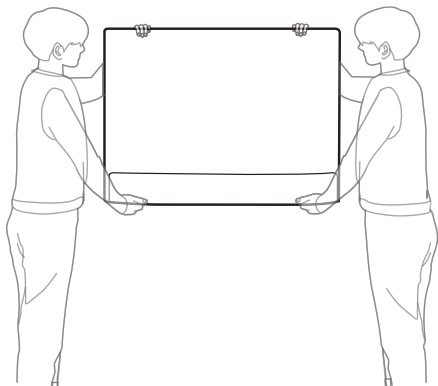

2

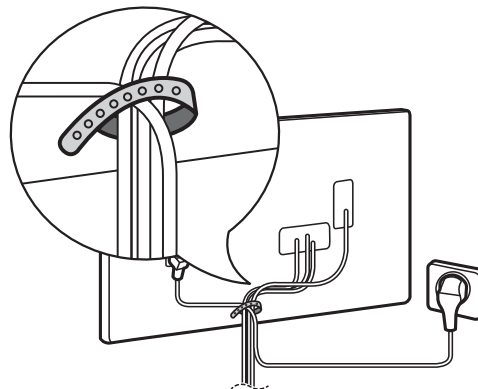

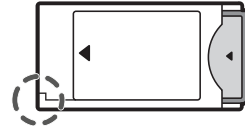
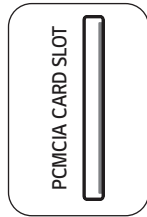
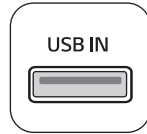
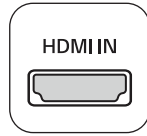
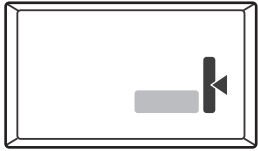

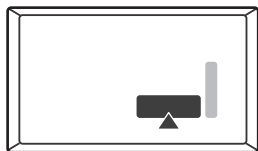

ANTENNA /
CABLE IN



Satellite IN



HDMI IN/ARC



HDMI IN



OPTICAL
DIGITAL
AUDIO OUT



+
EXTERNAL
SPEAKER OUT



+
AUDIO
LINE OUT



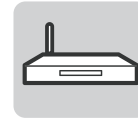
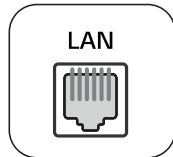
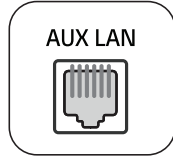
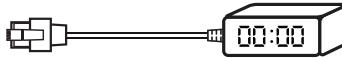
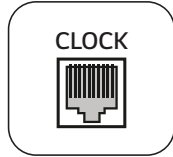
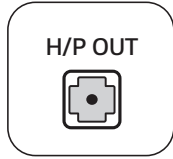
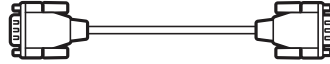
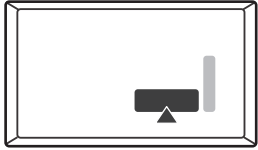

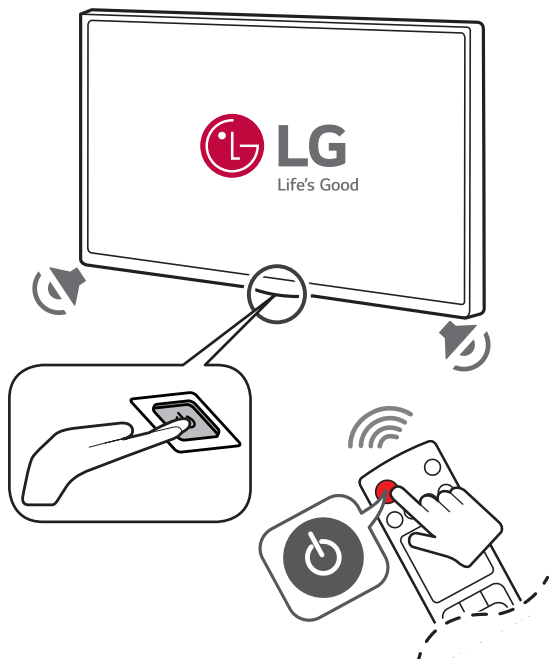
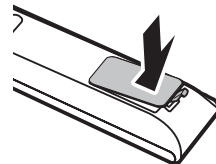
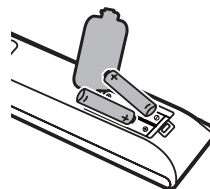
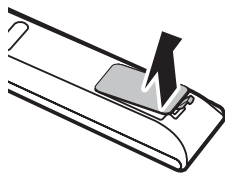
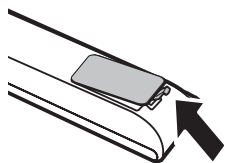
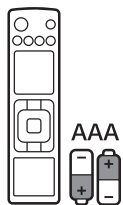

* M F L 7 1 6 9 7 8 0 2 *



(2108-REV02)

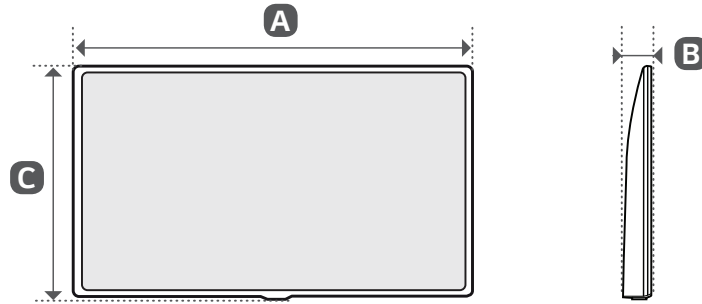

| | A | B | C | D |
|---|----------|----------|---------------------------|----------|
| | (mm) | | | (kg) |
| 43US662H0ZC 43US665H0ZC 43US662H9ZC | 973 | 85.0 | 572 | 8.0 |
| 50US662H0ZC 50US665H0ZC 50US662H9ZC | 1130 | 86.3 | 663 | 11.3 |
| 55US662H0ZC 55US665H0ZC 55US662H9ZC | 1244 | 87.1 | 726 | 14.3 |
| 65US662H0ZC 65US662H9ZC | 1463 | 87.8 | 850 | 21.4 |
| Power requirement | | | AC 100-240 V - 50 / 60 Hz | |