



# **MB2650, MX622, XM3250**

---

## **User's Guide**

**April 2018**

**[www.lexmark.com](http://www.lexmark.com)**

---

Machine type(s):

7018

Model(s):

676, 678, 679

# Contents

- Safety information.....7**
  - Conventions.....7
  - Product statements.....7
  
- Learning about the printer..... 10**
  - Finding information about the printer..... 10
  - Selecting a location for the printer..... 11
  - Printer configurations..... 13
  - Attaching cables..... 14
  - Using the control panel..... 15
  - Understanding the status of the power button and indicator light..... 15
  
- Setting up and using the home screen applications..... 17**
  - Using the home screen.....17
  - Customizing the home screen.....18
  - Setting up Card Copy.....18
  - Using Shortcut Center.....19
  - Using Display Customization..... 19
  - Configuring Eco-Settings..... 19
  - Using Customer Support.....19
  - Using QR Code Generator.....20
  - Setting up Scan Center.....20
  - Setting up Device Quotas.....20
  - Creating a Cloud Connector profile..... 21
  - Managing bookmarks.....21
    - Creating bookmarks ..... 21
    - Creating folders ..... 22
  - Managing contacts.....22
    - Adding contacts..... 22
    - Adding groups..... 23
    - Editing contacts or groups ..... 23
    - Deleting contacts or groups ..... 23
  
- Setting up and using the accessibility features..... 24**
  - Enabling Magnification mode.....24
  - Activating Voice Guidance.....24

Navigating the screen using gestures..... 24  
Adjusting the Voice Guidance speech rate.....25  
Using the keyboard on the display.....25  
Enabling spoken passwords or personal identification numbers..... 25

**Loading paper and specialty media..... 26**

Setting the size and type of the specialty media.....26  
Configuring Universal paper settings..... 26  
Loading trays..... 26  
Loading the multipurpose feeder..... 28  
Linking trays.....29

**Paper support.....30**

Supported paper sizes.....30  
Supported paper types..... 32  
Supported paper weights..... 32

**Printing..... 33**

Printing from a computer..... 33  
Printing from a mobile device..... 33  
Printing from a flash drive.....34  
Supported flash drives and file types..... 35  
Configuring confidential jobs..... 36  
Printing confidential and other held jobs..... 36  
Printing from a Cloud Connector profile.....37  
Printing a font sample list..... 37  
Printing a directory list.....37  
Canceling a print job.....38

**Copying..... 39**

Making copies..... 39  
Copying photos.....39  
Copying on letterhead..... 39  
Copying on both sides of the paper.....39  
Reducing or enlarging copies..... 40  
Collating copies..... 40  
Placing separator sheets between copies..... 40

Copying multiple pages onto a single sheet..... 40  
Creating a copy shortcut..... 40

**E-mailing..... 42**

Setting up the e-mail function..... 42  
Configuring e-mail settings..... 42  
Sending an e-mail..... 42  
Creating an e-mail shortcut..... 43

**Faxing..... 44**

Setting up the printer to fax..... 44  
Sending a fax..... 50  
Scheduling a fax..... 51  
Creating a fax destination shortcut..... 51  
Changing the fax resolution..... 51  
Adjusting the fax darkness..... 51  
Viewing a fax log..... 51  
Blocking junk faxes..... 52  
Holding faxes..... 52  
Forwarding a fax..... 52

**Scanning..... 53**

Scanning to an FTP server..... 53  
Creating an FTP shortcut..... 53  
Scanning to a flash drive..... 54  
Sending scanned documents to a computer..... 55

**Understanding the printer menus..... 56**

Menu map..... 56  
Device..... 57  
Print..... 68  
Paper..... 78  
Copy..... 80  
Fax..... 84  
E-mail..... 96  
FTP..... 104  
USB Drive..... 108

Network/Ports..... 114

Security..... 127

Reports..... 135

Help..... 136

Troubleshooting..... 136

Printing the Menu Settings Page..... 137

**Securing the printer..... 138**

Locating the security slot..... 138

Erasing printer memory..... 138

Erasing printer hard disk memory..... 138

Configuring printer hard disk encryption..... 139

Restoring factory default settings..... 139

Statement of Volatility..... 139

**Maintaining the printer..... 141**

Adjusting the speaker volume..... 141

Networking..... 142

Cleaning printer parts..... 144

Ordering parts and supplies..... 148

Replacing supplies..... 152

Moving the printer..... 164

Saving energy and paper..... 165

Recycling..... 166

**Clearing jams..... 167**

Avoiding jams..... 167

Identifying jam locations..... 168

Paper jam in door A..... 169

Paper jam in door B..... 173

Paper jam in the standard bin..... 174

Paper jam in the duplex unit..... 175

Paper jam in trays..... 176

Paper jam in the multipurpose feeder..... 176

Paper jam in the automatic document feeder..... 177

Paper jam in the finisher..... 178

Staple jam in the finisher..... 180

- Troubleshooting..... 182**
  - Network connection problems.....182
  - Hardware options problems..... 184
  - Issues with supplies..... 186
  - Paper feed problems.....187
  - Printing problems.....190
  - Faxing problems..... 219
  - Scanning problems..... 222
  - Contacting customer support.....226
  
- Upgrading and migrating..... 227**
  - Hardware.....227
  - Software..... 241
  - Firmware..... 242
  
- Notices..... 244**
  
- Index..... 259**

# Safety information

## Conventions

**Note:** A *note* identifies information that could help you.

**Warning:** A *warning* identifies something that could damage the product hardware or software.

**CAUTION:** A *caution* indicates a potentially hazardous situation that could injure you.

Different types of caution statements include:



**CAUTION—POTENTIAL INJURY:** Indicates a risk of injury.



**CAUTION—SHOCK HAZARD:** Indicates a risk of electrical shock.



**CAUTION—HOT SURFACE:** Indicates a risk of burn if touched.



**CAUTION—TIPPING HAZARD:** Indicates a crush hazard.



**CAUTION—PINCH HAZARD:** Indicates a risk of being caught between moving parts.

## Product statements



**CAUTION—POTENTIAL INJURY:** To avoid the risk of fire or electrical shock, connect the power cord to an appropriately rated and properly grounded electrical outlet that is near the product and easily accessible.



**CAUTION—POTENTIAL INJURY:** To avoid the risk of fire or electrical shock, use only the power cord provided with this product or the manufacturer's authorized replacement.



**CAUTION—POTENTIAL INJURY:** Do not use this product with extension cords, multioutlet power strips, multioutlet extenders, or UPS devices. The power capacity of these types of accessories can be easily overloaded by a laser printer and may result in a risk of fire, property damage, or poor printer performance.



**CAUTION—POTENTIAL INJURY:** Only a Lexmark Inline Surge Protector that is properly connected between the printer and the power cord provided with the printer may be used with this product. The use of non-Lexmark surge protection devices may result in a risk of fire, property damage, or poor printer performance.



**CAUTION—POTENTIAL INJURY:** To reduce the risk of fire, use only a 26 AWG or larger telecommunications (RJ-11) cord when connecting this product to the public switched telephone network. For users in Australia, the cord must be approved by the Australian Communications and Media Authority.





**CAUTION—SHOCK HAZARD:** To avoid the risk of electrical shock, do not place or use this product near water or wet locations.





**CAUTION—SHOCK HAZARD:** To avoid the risk of electrical shock, do not set up this product or make any electrical or cabling connections, such as the power cord, fax feature, or telephone, during a lightning storm.

 **CAUTION—POTENTIAL INJURY:** Do not cut, twist, bind, crush, or place heavy objects on the power cord. Do not subject the power cord to abrasion or stress. Do not pinch the power cord between objects such as furniture and walls. If any of these things happen, a risk of fire or electrical shock results. Inspect the power cord regularly for signs of such problems. Remove the power cord from the electrical outlet before inspecting it.

 **CAUTION—SHOCK HAZARD:** To avoid the risk of electrical shock, make sure that all external connections (such as Ethernet and telephone system connections) are properly installed in their marked plug-in ports.

 **CAUTION—SHOCK HAZARD:** To avoid the risk of electrical shock, if you are accessing the controller board or installing optional hardware or memory devices sometime after setting up the printer, then turn the printer off, and unplug the power cord from the electrical outlet before continuing. If you have any other devices attached to the printer, then turn them off as well, and unplug any cables going into the printer.

 **CAUTION—SHOCK HAZARD:** To avoid the risk of electrical shock, do not use the fax feature during a lightning storm.

 **CAUTION—SHOCK HAZARD:** To avoid the risk of electrical shock when cleaning the exterior of the printer, unplug the power cord from the electrical outlet and disconnect all cables from the printer before proceeding.





 **CAUTION—POTENTIAL INJURY:** If the printer weight is greater than 18 kg (40 lb), then it requires two or more trained personnel to lift it safely.

 **CAUTION—POTENTIAL INJURY:** When moving the printer, follow these guidelines to avoid personal injury or printer damage:

- Make sure that all doors and trays are closed.
- Turn off the printer, and then unplug the power cord from the electrical outlet.
- Disconnect all cords and cables from the printer.
- If the printer has separate floor-standing optional trays or output options attached to it, then disconnect them before moving the printer.
- If the printer has a caster base, then carefully roll it to the new location. Use caution when passing over thresholds and breaks in flooring.
- If the printer does not have a caster base but is configured with optional trays or output options, then remove the output options and lift the printer off the trays. Do not try to lift the printer and any options at the same time.
- Always use the handholds on the printer to lift it.
- Any cart used to move the printer must have a surface able to support the full footprint of the printer.
- Any cart used to move the hardware options must have a surface able to support the dimensions of the options.
- Keep the printer in an upright position.
- Avoid severe jarring movements.
- Make sure that your fingers are not under the printer when you set it down.
- Make sure that there is adequate clearance around the printer.

 **CAUTION—TIPPING HAZARD:** Installing one or more options on your printer or MFP may require a caster base, furniture, or other feature to prevent instability causing possible injury. For more information on supported configurations, see [www.lexmark.com/multifunctionprinters](http://www.lexmark.com/multifunctionprinters).



-  **CAUTION—TIPPING HAZARD:** To reduce the risk of equipment instability, load each tray separately. Keep all other trays closed until needed.
-  **CAUTION—HOT SURFACE:** The inside of the printer might be hot. To reduce the risk of injury from a hot component, allow the surface to cool before touching it.
-  **CAUTION—PINCH HAZARD:** To avoid the risk of a pinch injury, use caution in areas marked with this label. Pinch injuries may occur around moving parts, such as gears, doors, trays, and covers.
-  **CAUTION—POTENTIAL INJURY:** This product uses a laser. Use of controls or adjustments or performance of procedures other than those specified in the *User's Guide* may result in hazardous radiation exposure.
-  **CAUTION—POTENTIAL INJURY:** The lithium battery in this product is not intended to be replaced. There is a danger of explosion if a lithium battery is incorrectly replaced. Do not recharge, disassemble, or incinerate a lithium battery. Discard used lithium batteries according to the manufacturer's instructions and local regulations.

This product is designed, tested, and approved to meet strict global safety standards with the use of specific manufacturer's components. The safety features of some parts may not always be obvious. The manufacturer is not responsible for the use of other replacement parts.

Refer service or repairs, other than those described in the user documentation, to a service representative.

This product uses a printing process that heats the print media, and the heat may cause the media to release emissions. You must understand the section in your operating instructions that discusses the guidelines for selecting print media to avoid the possibility of harmful emissions.

This product may produce small amounts of ozone during normal operation, and may be equipped with a filter designed to limit ozone concentrations to levels well below the recommended exposure limits. To avoid high ozone concentration levels during extensive usage, install this product in a well-ventilated area and replace the ozone and exhaust filters if instructed to do so in the product maintenance instructions. If there are no references to filters in the product maintenance instructions, then there are no filters requiring replacement for this product.

**SAVE THESE INSTRUCTIONS.**

# Learning about the printer

## Finding information about the printer

What are you looking for?	Find it here
Initial setup instructions: <ul style="list-style-type: none"> <li>• Connecting the printer</li> <li>• Installing the printer software</li> </ul>	See the setup documentation that came with the printer or go to <a href="http://support.lexmark.com">http://support.lexmark.com</a> .
More setup and instructions for using the printer: <ul style="list-style-type: none"> <li>• Selecting and storing paper and specialty media</li> <li>• Loading paper</li> <li>• Configuring printer settings</li> <li>• Viewing and printing documents and photos</li> <li>• Setting up and using the printer software</li> <li>• Configuring the printer on a network</li> <li>• Caring for and maintaining the printer</li> <li>• Troubleshooting and solving problems</li> </ul>	<i>Information Center</i> —Go to <a href="http://infoserve.lexmark.com">http://infoserve.lexmark.com</a> . <i>Help Menu Pages</i> —Access the guides on the printer firmware or go to <a href="http://support.lexmark.com">http://support.lexmark.com</a> . <i>Touch Screen Guide</i> —Go to <a href="http://support.lexmark.com">http://support.lexmark.com</a> . Product videos—Go to <a href="http://infoserve.lexmark.com/idv/">http://infoserve.lexmark.com/idv/</a> .
Information on setting up and configuring the accessibility features of your printer	<i>Lexmark Accessibility Guide</i> —Go to <a href="http://support.lexmark.com">http://support.lexmark.com</a> .
Help using the printer software	Help for Microsoft® Windows® or Macintosh operating systems—Open a printer software program or application, and then click <b>Help</b> .  Click  to view context-sensitive information.  <b>Notes:</b> <ul style="list-style-type: none"> <li>• Help is automatically installed with the printer software.</li> <li>• Depending on the operating system, the printer software is located in the printer program folder or on the desktop.</li> </ul>

What are you looking for?	Find it here
<p>The latest supplemental information, updates, and customer support:</p> <ul style="list-style-type: none"> <li>• Documentation</li> <li>• Driver downloads</li> <li>• Live chat support</li> <li>• E-mail support</li> <li>• Voice support</li> </ul>	<p>Go to <a href="http://support.lexmark.com">http://support.lexmark.com</a>.</p> <p><b>Note:</b> Select your country or region, and then select your product to view the appropriate support site.</p> <p>Support contact information for your country or region can be found on the website or on the printed warranty that came with the printer.</p> <p>Have the following information ready when you contact customer support:</p> <ul style="list-style-type: none"> <li>• Place and date of purchase</li> <li>• Machine type and serial number</li> </ul> 
<ul style="list-style-type: none"> <li>• Safety information</li> <li>• Regulatory information</li> <li>• Warranty information</li> <li>• Environmental information</li> </ul>	<p>Warranty information varies by country or region:</p> <ul style="list-style-type: none"> <li>• <b>In the U.S.</b>—See the Statement of Limited Warranty included with the printer, or go to <a href="http://support.lexmark.com">http://support.lexmark.com</a>.</li> <li>• <b>In other countries and regions</b>—See the printed warranty that came with the printer.</li> </ul> <p><i>Product Information Guide</i>—See the documentation that came with the printer or go to <a href="http://support.lexmark.com">http://support.lexmark.com</a>.</p>

## Selecting a location for the printer

- Leave enough room to open trays, covers, and doors and to install hardware options.
- Set up the printer near an electrical outlet.

 **CAUTION—POTENTIAL INJURY:** To avoid the risk of fire or electrical shock, connect the power cord to an appropriately rated and properly grounded electrical outlet that is near the product and easily accessible.

 **CAUTION—SHOCK HAZARD:** To avoid the risk of electrical shock, do not place or use this product near water or wet locations.

- Make sure that airflow in the room meets the latest revision of the ASHRAE 62 standard or the CEN Technical Committee 156 standard.
- Provide a flat, sturdy, and stable surface.
- Keep the printer:
  - Clean, dry, and free of dust
  - Away from stray staples and paper clips
  - Away from the direct airflow of air conditioners, heaters, or ventilators
  - Free from direct sunlight and humidity extremes
- Observe the recommended temperatures and avoid fluctuations.

Ambient temperature	10 to 32°C (50 to 90°F)
Storage temperature	0 to 40°C (32 to 104°F)

- Allow the following recommended amount of space around the printer for proper ventilation:

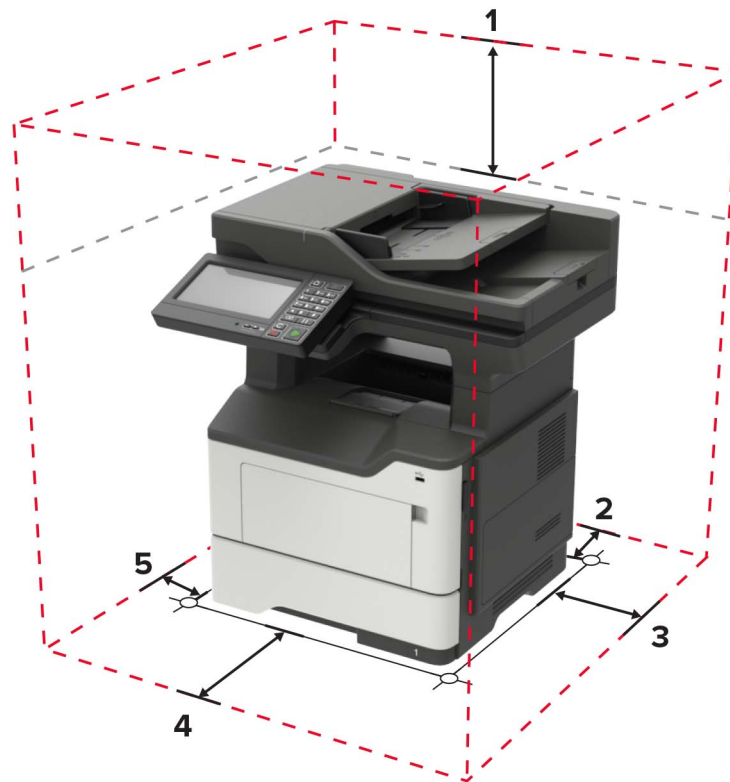

<b>1</b>	Top	800 mm (32 in.)
<b>2</b>	Rear	203 mm (8 in.)
<b>3</b>	Right side	305 mm (12 in.)
<b>4</b>	Front	510 mm (20 in.) <b>Note:</b> The minimum space needed in front of the printer is 76 mm (3 in.).
<b>5</b>	Left side	203 mm (8 in.)

## Printer configurations

**CAUTION—TIPPING HAZARD:** Installing one or more options on your printer or MFP may require a caster base, furniture, or other feature to prevent instability causing possible injury. For more information on supported configurations, see [www.lexmark.com/multifunctionprinters](http://www.lexmark.com/multifunctionprinters).

**CAUTION—TIPPING HAZARD:** Installing one or more options on your printer or MFP may require a caster base, furniture, or other feature to prevent instability causing possible injury. For more information on supported configurations, contact the place where you purchased the printer.

**CAUTION—TIPPING HAZARD:** To reduce the risk of equipment instability, load each tray separately. Keep all other trays closed until needed.

You can configure your printer by adding optional 250- or 550-sheet trays. For more information, see [“Installing optional trays” on page 240](#).

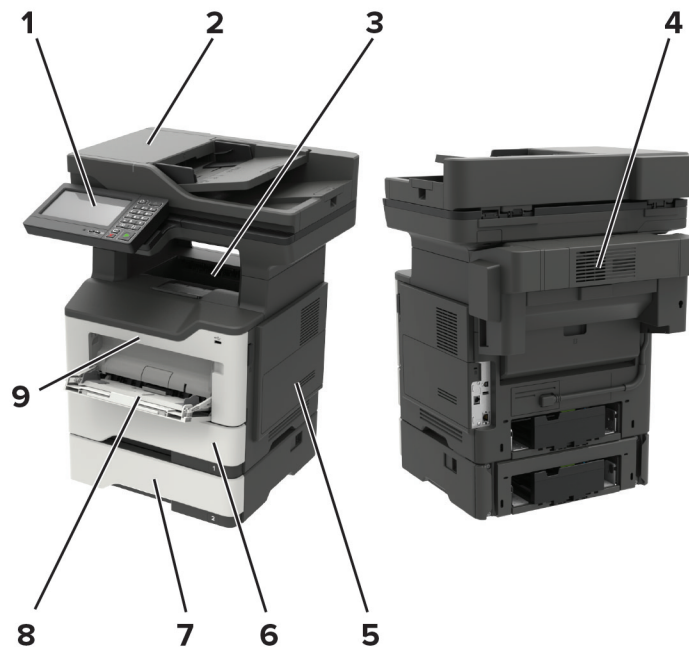

1	Control panel
2	Automatic document feeder (ADF)
3	Standard bin
4	Optional staple finisher
5	Controller board access cover
6	Standard 550-sheet tray
7	Optional 250- or 550-sheet tray
8	Multipurpose feeder
9	Door A

## Attaching cables

- ⚠ CAUTION—SHOCK HAZARD:** To avoid the risk of electrical shock, do not set up this product or make any electrical or cabling connections, such as the power cord, fax feature, or telephone, during a lightning storm.
- ⚠ CAUTION—POTENTIAL INJURY:** To avoid the risk of fire or electrical shock, connect the power cord to an appropriately rated and properly grounded electrical outlet that is near the product and easily accessible.
- ⚠ CAUTION—POTENTIAL INJURY:** To avoid the risk of fire or electrical shock, use only the power cord provided with this product or the manufacturer's authorized replacement.
- ⚠ CAUTION—POTENTIAL INJURY:** To reduce the risk of fire, use only a 26 AWG or larger telecommunications (RJ-11) cord when connecting this product to the public switched telephone network. For users in Australia, the cord must be approved by the Australian Communications and Media Authority.

**Warning—Potential Damage:** To avoid loss of data or printer malfunction, do not touch the USB cable, any wireless network adapter, or the printer in the areas shown while actively printing.



	Use the	To
1	Power cord socket	Connect the printer to an electrical outlet.
2	Ethernet port	Connect the printer to an Ethernet network.
3	LINE port	Connect the printer to an active telephone line through a standard wall jack (RJ-11), DSL filter, or VoIP adapter, or any other adapter that allows you to access the telephone line to send and receive faxes.
4	USB port	Attach a keyboard or any compatible option.
5	USB printer port	Connect the printer to a computer.

## Using the control panel

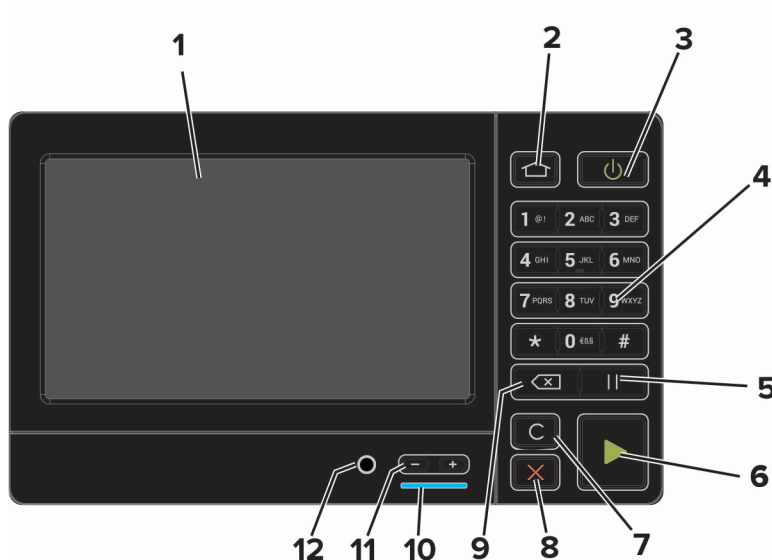

	Use the	To
1	Display	<ul style="list-style-type: none"> <li>View printer messages and supply status.</li> <li>Set up and operate the printer.</li> </ul>
2	Home button	Go to the home screen.
3	Power button	Turn on or turn off the printer. <b>Note:</b> To turn off the printer, press and hold the power button for five seconds.
4	Numeric keypad	Enter numbers or symbols in an input field.
5	Pause button	Place a dial pause in a fax number.
6	Start button	Start a job, depending on which mode is selected.
7	Clear all or Reset button	Reset the default settings of a function such as copying, faxing, or scanning.
8	Stop or Cancel button	Stop the current printer task.
9	Backspace button	Move the cursor backward and delete a character in an input field.
10	Indicator light	Check the status of the printer.
11	Volume buttons	Adjust the speaker volume.
12	Speaker port	Attach a speaker.

## Understanding the status of the power button and indicator light

Indicator light	Printer status
Off	The printer is off or in Hibernate mode.
Blue	The printer is ready or processing data.

Indicator light	Printer status
Red	The printer requires user intervention.

Power button light	Printer status
Off	The printer is off, ready, or processing data.
Solid amber	The printer is in Sleep mode.
Blinking amber	The printer is in Hibernate mode.



# Setting up and using the home screen applications

**Note:** These applications are supported only in some printer models.

## Using the home screen

**Note:** Your home screen may vary depending on your home screen customization settings, administrative setup, and active embedded solutions.



Touch		To
1	Copy	Make copies.
2	E-mail	Send e-mails.
3	Settings	Access the printer menus.
4	Fax	Send fax.
5	Address Book	Manage a contact list that other applications on the printer can access.
6	Status/Supplies	<ul style="list-style-type: none"> <li>Show a printer warning or error message whenever the printer requires intervention to continue processing.</li> <li>View more information on the printer warning or message, and on how to clear it.</li> </ul> <p><b>Note:</b> You can also access this setting by touching the top section of the home screen.</p>
7	USB Drive	<ul style="list-style-type: none"> <li>Print photos and documents from a flash drive.</li> <li>Scan photos and documents to a flash drive</li> </ul>
8	Job Queue	<p>Show all the current print jobs.</p> <p><b>Note:</b> You can also access this setting by touching the top section of the home screen.</p>
9	Held Jobs	Show the print jobs that are held in the printer memory.

Touch		To
10	Shortcut Center	Organize all shortcuts.
11	App Profiles	Access application profiles.
12	Scan Profiles	Scan and save documents directly to the computer.
13	FTP	Scan and save documents directly to an FTP server.
14	Bookmarks	Organize all bookmarks.
15	Change Language	Change the language on the display.

## Customizing the home screen

1 Open a web browser, and then type the printer IP address in the address field.

**Notes:**

- View the printer IP address on the printer home screen. The IP address appears as four sets of numbers separated by periods, such as 123.123.123.123.
- If you are using a proxy server, then temporarily disable it to load the web page correctly.

2 Click **Settings > Device > Visible Home Screen Icons**.

3 Select the icons that you want to appear on the home screen.

4 Apply the changes.

## Setting up Card Copy

1 Open a web browser, and then type the printer IP address in the address field.

**Notes:**

- View the printer IP address on the printer home screen. The IP address appears as four sets of numbers separated by periods, such as 123.123.123.123.
- If you are using a proxy server, then temporarily disable it to load the web page correctly.

2 Click **Apps > Card Copy > Configure**.

**Notes:**

- Make sure that Display Icon is enabled.
- Make sure that E-mail Settings and Network Share Settings are configured.
- When scanning a card, make sure that the scan resolution does not exceed 200 dpi for color and 400 dpi for black and white.
- When scanning multiple cards, make sure that the scan resolution does not exceed 150 dpi for color and 300 dpi for black and white.

3 Apply the changes.

**Note:** You need a printer hard disk to scan multiple cards.

## Using Shortcut Center

- 1 From the home screen, touch **Shortcut Center**, and then select a printer function.
- 2 Touch **Create Shortcut**, and then configure the settings.
- 3 Touch **Save**, and then type a unique shortcut name.
- 4 Apply the changes.

## Using Display Customization

Before using the application, make sure to do the following:

- Access the Embedded Web Server, and then configure the application.
- Enable and configure Slideshow Settings and Wallpaper Settings.

### Changing the wallpaper image

- 1 From the home screen, touch **Change Wallpaper**.
- 2 Select an image to use.
- 3 Apply the changes.

### Running a slide show from a flash drive

- 1 Insert a flash drive into the USB port.
- 2 From the home screen, touch **Slideshow**.  
Images appear in alphabetical order.

**Note:** You can remove the flash drive after the slide show starts, but the images are not stored in the printer. If the slide show stops, then insert the flash drive again to view the images.

## Configuring Eco-Settings

- 1 From the home screen, touch **Eco-Settings**.
- 2 Configure the Eco-Mode settings or schedule a power-saving mode.
- 3 Apply the changes.

## Using Customer Support

- 1 From the home screen, touch **Customer Support**.
- 2 Print or e-mail the information.

**Note:** For information on configuring the application settings, see the *Customer Support Administrator's Guide*.

## Using QR Code Generator

You may need administrative rights to access the application.

- 1 Open a Web browser, and then type the printer IP address in the address field.

**Notes:**

- View the printer IP address on the printer home screen. The IP address appears as four sets of numbers separated by periods, such as 123.123.123.123.
- If you are using a proxy server, then temporarily disable it to load the Web page correctly.

- 2 Click **Apps > QR Code Generator > Configure**.

- 3 Do either of the following:

- Select a default QR code value.
- Type a QR code value.

- 4 Apply the changes.

## Setting up Scan Center

- 1 From the home screen, touch **Scan Center**.

- 2 Select and create a destination, and then configure the settings.

**Notes:**

- When creating a network destination, make sure to validate and adjust the settings until no errors occur.
- Only destinations created from the Embedded Web Server are saved. For more information, see the documentation that came with the solution.

- 3 Apply the changes.

## Setting up Device Quotas

You may need administrative rights to access the application.

- 1 Open a Web browser, and then type the printer IP address in the address field.

**Notes:**

- View the printer IP address on the printer home screen. The IP address appears as four sets of numbers separated by periods, such as 123.123.123.123.
- If you are using a proxy server, then temporarily disable it to load the Web page correctly.

- 2 Click **Apps > Device Quotas > Configure**.

- 3 From the User Accounts section, add or edit a user, and then set the user quota.

- 4 Apply the changes.

**Note:** For information on how to configure the application and its security settings, see the *Device Quotas Administrator's Guide*.

## Creating a Cloud Connector profile

We recommend logging in to the printer before you create a profile. To enable a login method, see the *Embedded Web Server - Security Admin Guide*.

- 1 From the home screen, touch **Cloud Connector**.
- 2 Select a cloud service provider.
- 3 Touch **Create a Profile** or .
- 4 Type a unique profile name.
- 5 If necessary, enter a PIN.  
**Note:** When using the printer as guest, protect the profile with a PIN.
- 6 Touch **Create**, and then take note of the authorization code.  
**Note:** The authorization code is valid only for 24 hours.
- 7 Open a web browser, and then go to <https://lexmark.cloud-connect.co>.
- 8 Click **Next**, and then accept the Terms of Use.
- 9 Enter the authorization code, and then click **Connect**.
- 10 Log in to your cloud service provider account.
- 11 Grant permissions.

**Note:** To complete the authorization process, open the profile within 72 hours.

## Managing bookmarks

### Creating bookmarks

Use bookmarks to print frequently accessed documents that are stored in servers or on the web.

- 1 Open a web browser, and then type the printer IP address in the address field.  
**Notes:**
  - View the printer IP address on the printer home screen. The IP address appears as four sets of numbers separated by periods, such as 123.123.123.123.
  - If you are using a proxy server, then temporarily disable it to load the web page correctly.
- 2 Click **Bookmark Setup** > **Add Bookmark**, and then type a unique name for the bookmark.
- 3 Select an Address protocol type, and then do one of the following:
  - For HTTP and HTTPS, type the URL that you want to bookmark.
  - For HTTPS, make sure to use the host name instead of the IP address. For example, type **myWebsite.com/sample.pdf** instead of typing **123.123.123.123/sample.pdf**. Make sure that the host name also matches the Common Name (CN) value in the server certificate. For more information on obtaining the CN value in the server certificate, see the help information for your web browser.

- For FTP, type the FTP address. For example, **myServer/myDirectory**. Enter the FTP port. Port 21 is the default port for sending commands.
- For SMB, type the network folder address. For example, **myServer/myShare/myFile.pdf**. Type the network domain name.
- If necessary, select the Authentication type for FTP and SMB.

To limit access to the bookmark, enter a PIN.

**Note:** The application supports the following file types: PDF, JPEG, TIFF, and HTML-based web pages. Other file types such as DOCX and XLXS are supported in some printer models.

**4** Click **Save**.

**Note:** To manage bookmarks, click **Bookmark Setup**.

## Creating folders

**1** Open a web browser, and then type the printer IP address in the address field.

**Notes:**

- View the printer IP address on the printer home screen. The IP address appears as four sets of numbers separated by periods, such as 123.123.123.123.
- If you are using a proxy server, then temporarily disable it to load the web page correctly.

**2** Click **Bookmark Setup > Add Folder**, and then type a unique name for the folder.

**Note:** To limit access to the folder, enter a PIN.

**3** Click **Save**.

**Notes:**

- You can create folders or bookmarks inside a folder. To create a bookmark, see [“Creating bookmarks” on page 21](#).
- To manage folders, click **Bookmark Setup**.

## Managing contacts

### Adding contacts

**1** Open a web browser, and then type the printer IP address in the address field.

**Notes:**

- View the printer IP address on the printer home screen. The IP address appears as four sets of numbers separated by periods, such as 123.123.123.123.
- If you are using a proxy server, then temporarily disable it to load the web page correctly.

**2** Click **Address Book**.

**3** From the Contacts section, add a contact.

**Note:** You can assign the contact to one or more groups.

- 4 If necessary, specify a login method to allow application access.
- 5 Apply the changes.

## Adding groups

- 1 Open a web browser, and then type the printer IP address in the address field.

**Notes:**

- View the printer IP address on the printer home screen. The IP address appears as four sets of numbers separated by periods, such as 123.123.123.123.
- If you are using a proxy server, then temporarily disable it to load the web page correctly.

- 2 Click **Address Book**.
- 3 From the Contact Groups section, add a group name.

**Note:** You can assign one or more contacts to the group.

- 4 Apply the changes.

## Editing contacts or groups

- 1 Open a web browser, and then type the printer IP address in the address field.

**Notes:**

- View the printer IP address on the printer home screen. The IP address appears as four sets of numbers separated by periods, such as 123.123.123.123.
- If you are using a proxy server, then temporarily disable it to load the web page correctly.

- 2 Click **Address Book**.
- 3 Do either of the following:
  - From the Contacts section, click a contact name, and then edit the information.
  - From the Contact Groups section, click a group name, and then edit the information.
- 4 Apply the changes.

## Deleting contacts or groups

- 1 Open a web browser, and then type the printer IP address in the address field.

**Notes:**

- View the printer IP address on the printer home screen. The IP address appears as four sets of numbers separated by periods, such as 123.123.123.123.
- If you are using a proxy server, then temporarily disable it to load the web page correctly.

- 2 Click **Address Book**.
- 3 Do either of the following:
  - From the Contacts section, select a contact that you want to delete.
  - From the Contact Groups section, select a group name that you want to delete.

# Setting up and using the accessibility features

**Note:** For more information on the accessibility features of your printer model, see the Accessibility Guide at <http://support.lexmark.com>.

## Enabling Magnification mode

- 1 From the control panel, press and hold the **5** key until you hear a voice message.
- 2 Select **Magnification mode**.
- 3 Select **OK**.

For more information on navigating a magnified screen, see [“Navigating the screen using gestures” on page 24](#).

## Activating Voice Guidance

### From the control panel

- 1 Press and hold the **5** key until you hear a voice message.
- 2 Select **OK**.

### From the keyboard

- 1 Press and hold the **5** key until you hear a voice message.
- 2 Press **Tab** to navigate the focus cursor to the OK button, and then press **Enter**.

#### Notes:

- Voice Guidance is also activated when you insert headphones into the headphone jack.
- To adjust the volume, use the volume buttons at the bottom part of the control panel.

## Navigating the screen using gestures

#### Notes:

- The gestures are applicable only when Voice Guidance is activated.
- Enable Magnification to use the zoom and pan gestures.
- Use a physical keyboard to type characters and adjust certain settings.

Gesture	Function
Double-tap	Select an option or item on the screen.
Triple-tap	Zoom in or zoom out text and images.
Swipe right or swipe down	Move to the next item on the screen.
Swipe left or swipe up	Move to the previous item on the screen.



Gesture	Function
Pan	Access parts of the zoomed image that are beyond the limits of the screen. <b>Note:</b> This gesture requires the use of two fingers to drag across a zoomed image.
Swipe up then left	Exit an application and return to the home screen.
Swipe down then left	<ul style="list-style-type: none"><li>• Cancel a job.</li><li>• Go back to the previous setting.</li><li>• Exit the screen that appears without changing any setting or value.</li></ul>
Swipe up then down	Repeat a spoken prompt.

## Adjusting the Voice Guidance speech rate

- 1 From the home screen, select **Settings > Device > Accessibility > Speech Rate**.
- 2 Select the speech rate.

## Using the keyboard on the display

Do one or more of the following:

- Drag a finger over the key to announce the character.
- Lift the finger to enter or type the character in the field.
- Select **Backspace** to delete characters.
- To hear the content in the input field, select **Tab**, and then select **Shift + Tab**.

## Enabling spoken passwords or personal identification numbers

- 1 From the home screen, select **Settings > Device > Accessibility > Speak Passwords/PINs**.
- 2 Enable the setting.

# Loading paper and specialty media

## Setting the size and type of the specialty media

The trays automatically detect the size of plain paper. For specialty media like labels, card stock, or envelopes, do the following:

- 1 From the home screen, navigate to:  
**Settings** > **Paper** > **Tray Configuration** > **Paper Size/Type** > select a paper source
- 2 Set the size and type of the specialty media.

## Configuring Universal paper settings

- 1 From the home screen, touch **Settings** > **Paper** > **Media Configuration** > **Universal Setup**.
- 2 Configure the settings.

## Loading trays



**CAUTION—TIPPING HAZARD:** To reduce the risk of equipment instability, load each tray separately. Keep all other trays closed until needed.

- 1 Remove the tray.

**Note:** To avoid paper jams, do not remove trays while the printer is busy.

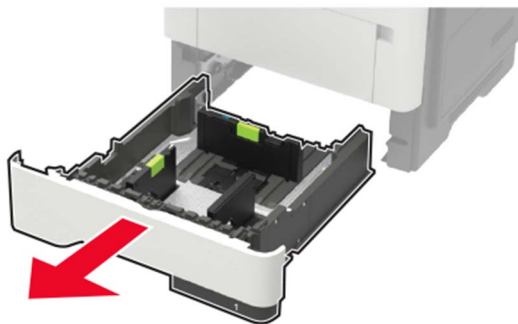

- 2** Adjust the paper guides to match the size of the paper that you are loading.

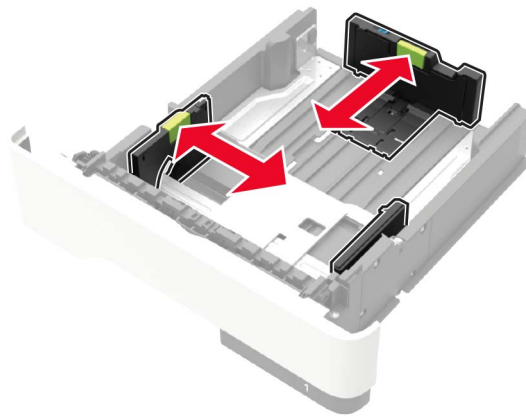

- 3** Flex, fan, and align the paper edges before loading.

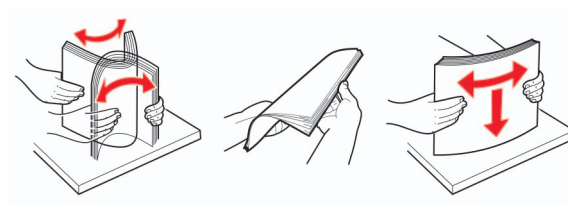

- 4** Load the paper stack with the printable side facedown, and then make sure that the side guides fit snugly against the paper.

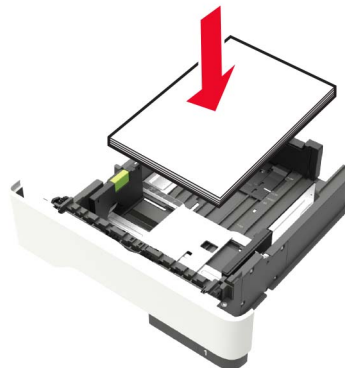

**Notes:**

- Load letterhead facedown with the top edge of the sheet toward the front of the tray for one-sided printing.
- Load letterhead faceup with the bottom edge of the sheet toward the front of the tray for two-sided printing.
- Do not slide paper into the tray.
- To avoid paper jams, make sure that the stack height is below the maximum paper fill indicator.

- 5** Insert the tray.

If necessary, set the paper size and paper type from the control panel to match the paper loaded.

## Loading the multipurpose feeder

- 1 Open the multipurpose feeder.

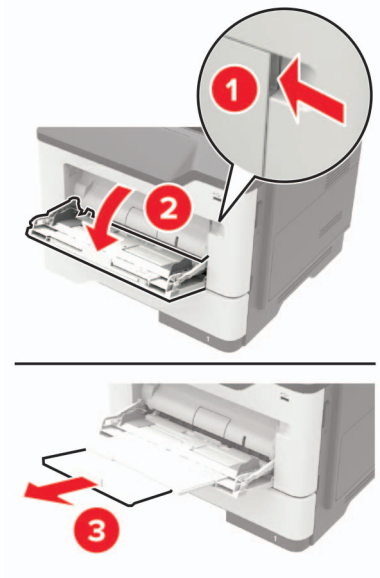

- 2 Adjust the guide to match the size of the paper that you are loading.

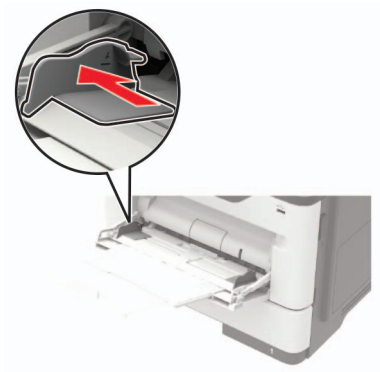

- 3 Flex, fan, and align the paper edges before loading.

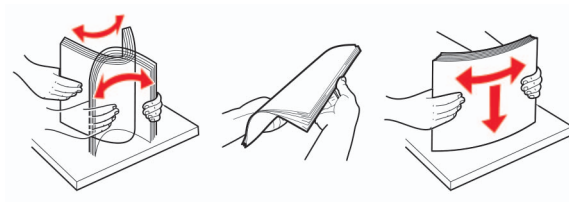

- 4 Load paper with the printable side faceup.

**Notes:**

- Load letterhead faceup with the top edge of the sheet toward the front of the tray for one-sided printing.
- Load letterhead facedown with the bottom edge of the sheet toward the front of the tray for two-sided printing.

- Load envelopes with the flap facedown on the left side.
- Load European envelopes with the flap facedown and entering the printer first.

**Warning—Potential Damage:** Do not use envelopes with stamps, clasps, snaps, windows, coated linings, or self-stick adhesives.

**5** From the control panel, set the paper size and paper type to match the paper loaded.

## Linking trays

**1** Open a web browser, and then type the printer IP address in the address field.

**Notes:**

- View the printer IP address on the printer home screen. The IP address appears as four sets of numbers separated by periods, such as 123.123.123.123.
- If you are using a proxy server, then temporarily disable it to load the web page correctly.

**2** Click **Settings > Paper > Tray Configuration**.

**3** Set the same paper size and paper type for the trays that you are linking.

**4** Save the settings.

**5** Click **Settings > Device > Maintenance > Configuration Menu > Tray Configuration**.

**6** Set Tray Linking to **Automatic**.

**7** Save the settings.

To unlink trays, make sure that no trays have the same paper size and paper type settings.

**Warning—Potential Damage:** The temperature of the fuser varies according to the specified paper type. To avoid printing issues, match the paper type setting in the printer with the paper loaded in the tray.

# Paper support

## Supported paper sizes

Paper size	Tray	Multipurpose feeder	Two-sided printing	ADF	Scanner glass
<b>A4</b> 210 x 297 mm (8.3 x 11.7 in.)	✓	✓	✓	✓	✓
<b>A5</b> 210 x 148 mm (5.8 x 8.3 in.)	✓	✓	x	✓	✓
<b>A5 LEF*</b> 148 x 210 mm (5.8 x 8.3 in.)	✓	✓	x	✓	✓
<b>A6*</b> 105 x 148 mm (4.1 x 5.8 in.)	✓	✓	x	✓	✓
<b>JIS B5</b> 182 x 257 mm (7.2 x 10.1 in.)	✓	✓	x	✓	✓
<b>Oficio (Mexico)</b> 216 x 340 mm (8.5 x 13.4 in.)	✓	✓	✓	✓	✓
<b>Hagaki</b> 100 x 148 mm (3.9 x 5.8 in.)	x	✓	x	x	✓
<b>Business card</b> 50.8 x 88.9 mm (2 x 3.5 in.)	x	x	x	x	✓
<b>Statement</b> 140 x 216 mm (5.5 x 8.5 in.)	✓	✓	x	✓	✓
<b>Executive</b> 184 x 267 mm (7.3 x 10.5 in.)	✓	✓	x	✓	✓
<b>Letter</b> 216 x 279 mm (8.5 x 11 in.)	✓	✓	✓	✓	✓

\* This paper size is not supported in the optional tray.

Paper size	Tray	Multipurpose feeder	Two-sided printing	ADF	Scanner glass
<b>Legal</b> 216 x 356 mm (8.5 x 14 in.)	✓	✓	✓	✓	✓
<b>Folio</b> 216 x 330 mm (8.5 x 13 in.)	✓	✓	✓	✓	✓
<b>Universal</b> 76.2 x 127 mm to 216 x 356 mm (3 x 5 in. to 8.5 x 14 in.)	✓	✓	x	✓	✓
<b>7 3/4 Envelope (Monarch)</b> 98 x 191 mm (3.9 x 7.5 in.)	x	✓	x	x	✓
<b>9 Envelope</b> 98 x 225 mm (3.9 x 8.9 in.)	x	✓	x	x	✓
<b>10 Envelope</b> 105 x 241 mm (4.1 x 9.5 in.)	x	✓	x	x	✓
<b>DL Envelope</b> 110 x 220 mm (4.3 x 8.7 in.)	x	✓	x	x	✓
<b>C5 Envelope</b> 162 x 229 mm (6.4 x 9 in.)	x	✓	x	x	✓
<b>B5 Envelope</b> 176 x 250 mm (6.9 x 9.8 in.)	x	✓	x	x	✓
<b>Other Envelope</b> 76.2 x 127 mm to 216 x 356 mm (3 x 5 in. to 8.5 x 14 in.)	x	✓	x	x	✓

\* This paper size is not supported in the optional tray.

## Supported paper types

Paper type	Tray	Multipurpose feeder	Two-sided printing	ADF	Scanner glass
Plain paper	✓	✓	✓	✓	✓
Card stock	X	✓	X	X	✓
Transparency	✓	✓	X	X	✓
Recycled	✓	✓	✓	✓	✓
Paper labels <sup>1</sup>	✓	✓	X	X	✓
Bond <sup>2</sup>	✓	✓	✓	✓	✓
Letterhead	✓	✓	✓	✓	✓
Preprinted	✓	✓	✓	✓	✓
Colored Paper	✓	✓	✓	✓	✓
Light Paper	✓	✓	✓	✓	✓
Heavy Paper <sup>2</sup>	✓	✓	✓	✓	✓
Rough/Cotton	✓	✓	✓	✓	✓
Envelope	X	✓	X	X	✓
Rough envelope	X	✓	X	X	✓

<sup>1</sup> One-sided paper labels designed for laser printers are supported for occasional use. It is recommended to print 20 or fewer pages of paper labels per month. Vinyl, pharmacy, and two-sided labels are not supported.

<sup>2</sup> Bond and Heavy Paper are supported in two-sided printing up to 90-g/m<sup>2</sup> (24-lb) paper weight.

## Supported paper weights

	Tray	Multipurpose feeder	Two-sided printing	ADF
Paper weight	60–120 g/m <sup>2</sup> (16–32 lb)	60–216 g/m <sup>2</sup> (16–58 lb)	60–90 g/m <sup>2</sup> (16–24 lb)	52–120 g/m <sup>2</sup> (14–32 lb)



# Printing

## Printing from a computer

**Note:** For labels, card stock, and envelopes, set the paper size and type in the printer before printing the document.

- 1 From the document that you are trying to print, open the Print dialog.
- 2 If necessary, adjust the settings.
- 3 Print the document.

## Printing from a mobile device

### Printing from a mobile device using Lexmark Mobile Print

Lexmark™ Mobile Print allows you to send documents and images directly to a supported Lexmark printer.

- 1 Open the document, and then send or share the document to Lexmark Mobile Print.

**Note:** Some third-party applications may not support the send or share feature. For more information, see the documentation that came with the application.

- 2 Select a printer.
- 3 Print the document.

### Printing from a mobile device using Google Cloud Print

Google Cloud Print™ is a mobile printing service that allows enabled applications on mobile devices to print to any Google Cloud Print-ready printer.

- 1 From the home screen of your mobile device, launch an enabled application.
- 2 Tap **Print**, and then select a printer.
- 3 Print the document.

### Printing from a mobile device using Mopria Print Service

Mopria® Print Service is a mobile printing solution for mobile devices running on Android version 4.4 or later. It allows you to print directly to any Mopria-certified printer.

**Note:** Before printing, make sure that the Mopria Print Service is enabled.

- 1 From the home screen of your mobile device, launch a compatible application.
- 2 Tap **Print**, and then select a printer.
- 3 Print the document.

## Printing from a mobile device using AirPrint

AirPrint is a mobile printing solution that allows you to print directly from Apple devices to an AirPrint-certified printer.

**Note:** This application is supported only in some Apple devices.

- 1 From the home screen of your mobile device, launch a compatible application.
- 2 Select an item to print, and then tap the share icon.
- 3 Tap **Print**, and then select the printer.
- 4 Send the print job.

## Printing from a flash drive

This feature is available only in some printer models.

- 1 Insert the flash drive.



### Notes:

- If you insert the flash drive when an error message appears, then the printer ignores the flash drive.
- If you insert the flash drive while the printer is processing other print jobs, then **Busy** appears on the display.

- 2 Select the document that you want to print.

If necessary, configure other print settings.

- 3 Print the document.

To print another document, select **USB Drive**.

**Warning—Potential Damage:** To avoid loss of data or printer malfunction, do not touch the flash drive or the printer in the area shown while actively printing, reading, or writing from the memory device.



## Supported flash drives and file types

### Flash drives

- Lexar JumpDrive S70 (16GB and 32GB)
- SanDisk Cruzer (16GB and 32GB)
- PNY Attache (16GB and 32GB)

### Notes:

- The printer supports high-speed USB flash drives with full-speed standard.
- USB flash drives must support the File Allocation Table (FAT) system.

### File types

#### Documents

- PDF (version 1.7 or earlier)
- HTML
- XPS
- Microsoft file formats (.doc, .docx, .xls, .xlsx, .ppt, .pptx)

#### Images

- .dcx
- .gif
- .JPEG or .jpg
- .bmp
- .pcx
- .TIFF or .tif
- .png

## Configuring confidential jobs

1 From the control panel, navigate to:

**Settings > Security > Confidential Print Setup**

For non-touch-screen printer models, press  to navigate through the settings.

In some printer models, access the setting from the Embedded Web Server.

2 Configure the settings.

Use	To
Max Invalid PIN	Set the number of times an invalid PIN can be entered. <b>Note:</b> When the limit is reached, the print jobs for that user name are deleted.
Confidential Job Expiration	Set the expiration time for confidential print jobs. <b>Note:</b> Confidential held jobs are stored in the printer until they are released or deleted manually.
Repeat Job Expiration	Set the expiration time for a repeat print job. <b>Note:</b> Repeat held jobs are stored in the printer memory for reprinting.
Verify Job Expiration	Set the expiration time that the printer prints a copy before printing the remaining copies. <b>Note:</b> Verify jobs print one copy to check if it is satisfactory before printing the remaining copies.
Reserve Job Expiration	Set the expiration time that the printer stores print jobs. <b>Note:</b> Reserve held jobs are automatically deleted after printing.
Require All Jobs to be Held	Set the printer to hold all print jobs.

## Printing confidential and other held jobs

### For Windows users

- 1 With a document open, click **File > Print**.
- 2 Click **Properties, Preferences, Options, or Setup**.
- 3 Click **Print and Hold**.
- 4 Select **Use Print and Hold**, and then assign a user name.
- 5 Select the print job type (Confidential, Repeat, Reserve, or Verify).  
If the print job is confidential, then enter a four-digit PIN.
- 6 Click **OK** or **Print**.

**7** From the printer home screen, release the print job.

- For confidential print jobs, navigate to:  
**Held jobs** > select your user name > **Confidential** > enter the PIN > select the print job > configure the settings > **Print**
- For other print jobs, navigate to:  
**Held jobs** > select your user name > select the print job > configure the settings > **Print**

## For Macintosh users

**1** With a document open, choose **File** > **Print**.

If necessary, click the disclosure triangle to see more options.

**2** From the print options or Copies & Pages menu, choose **Job Routing**.

**3** Select the print job type (Confidential, Repeat, Reserve, or Verify).

If the print job is confidential, then assign a user name and a four-digit PIN.

**4** Click **OK** or **Print**.

**5** From the printer home screen, release the print job.

- For confidential print jobs, navigate to:  
**Held jobs** > select your user name > **Confidential** > enter the PIN > select the print job > configure the settings > **Print**
- For other print jobs, navigate to:  
**Held jobs** > select your user name > select the print job > configure the settings > **Print**

## Printing from a Cloud Connector profile

**1** From the home screen, touch **Cloud Connector**.

**2** Select a cloud service provider, and then select a profile.

**Note:** For more information on creating a Cloud Connector profile, see [“Creating a Cloud Connector profile” on page 21](#).

**3** Select a file.

**Note:** You cannot select an unsupported file.

**4** If necessary, change the settings.

**5** Touch **Print**.

## Printing a font sample list

**1** From the home screen, touch **Settings** > **Reports** > **Print** > **Print Fonts**.

**2** Touch **PCL Fonts** or **PostScript Fonts**.

## Printing a directory list

From the home screen, touch **Settings** > **Reports** > **Print** > **Print Directory**.

## Canceling a print job

### From the printer control panel

- 1 From the home screen, touch **Job Queue**.

**Note:** You can also access this setting by touching the top section of the home screen.

- 2 Select the job to cancel.

### From the computer

- 1 Depending on the operating system, do either of the following:
  - Open the printers folder, and then select your printer.
  - From the System Preferences in the Apple menu, navigate to your printer.
- 2 Select the job to cancel.

# Copying

## Making copies

- 1 Load an original document into the ADF tray or on the scanner glass.

**Note:** To avoid a cropped image, make sure that the original document and output have the same paper size.

- 2 From the home screen, touch **Copy**, and then specify the number of copies.  
If necessary, adjust the copy settings.
- 3 Copy the document.

**Note:** To make a quick copy, from the control panel, press .

## Copying photos

- 1 Place a photo on the scanner glass.
- 2 From the home screen, navigate to:  
**Copy > Content > Content Type > Photo**
- 3 In the Content Source menu, select the setting that best matches the original photo.
- 4 Copy the photo.

## Copying on letterhead

- 1 Load an original document into the ADF tray or on the scanner glass.
- 2 From the home screen, touch **Copy > Copy From** > select the size of the original document.
- 3 Touch **Copy To**, and then select the paper source that contains the letterhead.  
If you loaded the letterhead into the multipurpose feeder, then navigate to:  
**Copy To > Multipurpose Feeder** > select a paper size > **Letterhead**
- 4 Copy the document.

## Copying on both sides of the paper

- 1 Load an original document into the ADF tray or on the scanner glass.
- 2 From the control panel, navigate to:  
**Copy > Settings > Paper Setup**

For non-touch-screen printer models, press  to navigate through the settings.

- 3 Adjust the settings.
- 4 Copy the document.

## Reducing or enlarging copies

- 1 Load an original document into the ADF tray or on the scanner glass.
- 2 From the home screen, navigate to:  
**Copy > Scale** > specify a scale value

**Note:** Changing the size of the original document or output after setting Scale restores the scale value to Auto.

- 3 Copy the document.

## Collating copies

- 1 Load an original document into the ADF tray or on the scanner glass.
- 2 From the home screen, touch **Copy**, and then set Collate to **On**.
- 3 Copy the document.

## Placing separator sheets between copies

- 1 Load an original document into the ADF tray or on the scanner glass.
- 2 From the home screen, touch **Copy > Separator Sheets**.
- 3 Adjust the settings.
- 4 Send the copy job.

## Copying multiple pages onto a single sheet

- 1 Load an original document into the ADF tray or on the scanner glass.
- 2 From the home screen, touch **Copy > Pages per Side**.
- 3 Adjust the settings.
- 4 Copy the document.

## Creating a copy shortcut

**Note:** You may need administrative rights to create a shortcut.

- 1 Open a web browser, and then type the printer IP address in the address field.



**Notes:**

- View the printer IP address on the home screen. The IP address appears as four sets of numbers separated by periods, such as 123.123.123.123.
- If you are using a proxy server, then temporarily disable it to load the web page correctly.

**2** Click **Shortcuts > Add Shortcut**.

**3** From the Shortcut Type menu, select **Copy**, and then configure the settings.

**4** Apply the changes.

# E-mailing

## Setting up the e-mail function

- 1 From the home screen, touch **Settings** > **Device** > **Preferences** > **Run Initial Setup**.
- 2 Turn off the printer, wait for about 10 seconds, and then turn it back on.
- 3 From the Before You Begin screen, select **Change the Settings and Continue with the Wizard**.
- 4 From the Fax/Email Server Setup screen, enter the needed information.
- 5 Finish the setup.

## Configuring e-mail settings

- 1 Open a Web browser, and then type the printer IP address in the address field.

**Notes:**

- View the printer IP address on the printer home screen. The IP address appears as four sets of numbers separated by periods, such as 123.123.123.123.
- If you are using a proxy server, then temporarily disable it to load the Web page correctly.

- 2 Click **Settings** > **E-mail**.
- 3 Enter the needed information.
- 4 Apply the changes.

## Sending an e-mail

### Using the control panel

- 1 Load an original document into the ADF tray or on the scanner glass.
- 2 From the home screen, touch **E-mail**, and then enter the needed information.

**Note:** You can also enter the recipient using the address book or shortcut number.
- 3 If necessary, configure the output file type settings.
- 4 Send the e-mail.

### Using the shortcut number

- 1 From the control panel, press **#**, and then enter the shortcut number using the keypad.
- 2 Send the e-mail.

## Creating an e-mail shortcut

**Note:** You may need administrative rights to create a shortcut.

- 1 Open a web browser, and then type the printer IP address in the address field.

**Notes:**

- View the printer IP address on the home screen. The IP address appears as four sets of numbers separated by periods, such as 123.123.123.123.
- If you are using a proxy server, then temporarily disable it to load the web page correctly.

- 2 Click **Shortcuts > Add Shortcut**.

- 3 From the Shortcut Type menu, select **E-mail**, and then configure the settings.

- 4 Apply the changes.

# Faxing

## Setting up the printer to fax

### Notes:

- The following connection methods are applicable only in some countries or regions.
- During the initial printer setup, clear the fax function check box and any other function you plan to set up later, and then touch **Continue**.
- If the fax function is enabled and not fully set up, then the indicator light may blink red.

**Warning—Potential Damage:** Do not touch cables or the printer in the area shown while actively sending or receiving a fax.



## Setting up the fax function

- 1 From the home screen, touch **Settings > Device > Preferences > Run Initial Setup**.
- 2 Turn off the printer, wait for about 10 seconds, and then turn it back on.
- 3 From the Before You Begin screen, select **Change the Settings and Continue with the Wizard**.
- 4 From the Fax/Email Server Setup screen, enter the needed information.
- 5 Finish the setup.

## Setting up fax using a standard telephone line

**⚡ CAUTION—SHOCK HAZARD:** To avoid the risk of electrical shock, do not set up this product or make any electrical or cabling connections, such as the power cord, fax feature, or telephone, during a lightning storm.

**⚠ CAUTION—SHOCK HAZARD:** To avoid the risk of electrical shock, do not use the fax feature during a lightning storm.

**⚠ CAUTION—POTENTIAL INJURY:** To reduce the risk of fire, use only a 26 AWG or larger telecommunications (RJ-11) cord when connecting this product to the public switched telephone network. For users in Australia, the cord must be approved by the Australian Communications and Media Authority.

### Setup 1: Printer is connected to a dedicated fax line

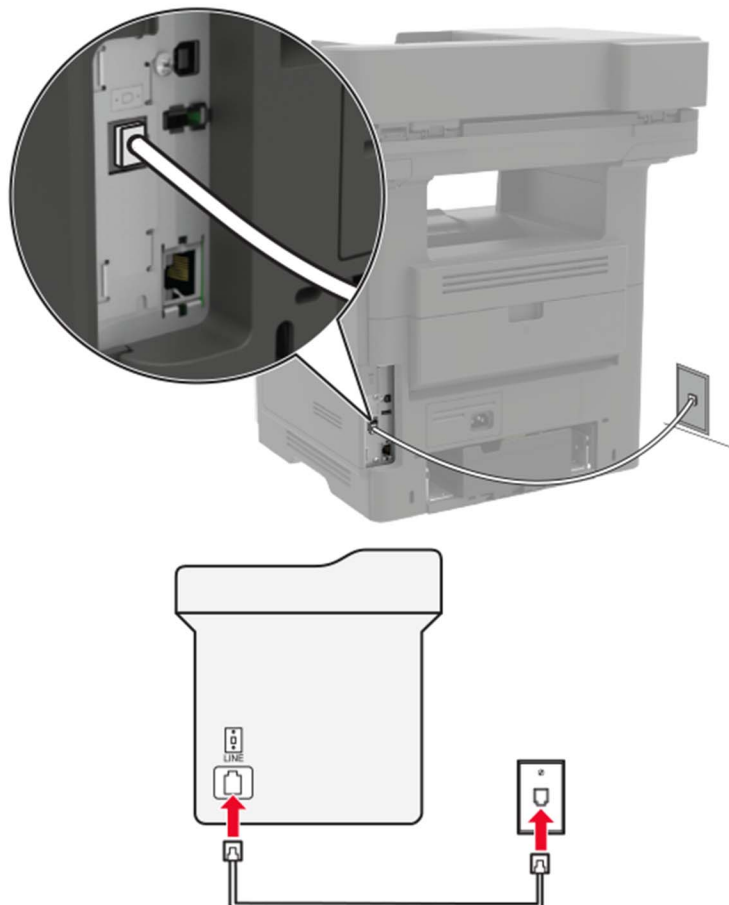

**1** Connect one end of the telephone cable to the line port of the printer.

**2** Connect the other end of the cable to an active analog wall jack.

#### Notes:

- You can set the printer to receive faxes automatically (Auto Answer On) or manually (Auto Answer Off).
- If you want to receive faxes automatically, then set the printer to pick up on a specified number of rings.

### Setup 2: Printer is sharing the line with an answering machine

**Note:** If you subscribe to a distinctive ring service, then make sure that you set the correct ring pattern for the printer. Otherwise, the printer does not receive faxes even if you have set it to receive faxes automatically.

### Connected to different wall jacks

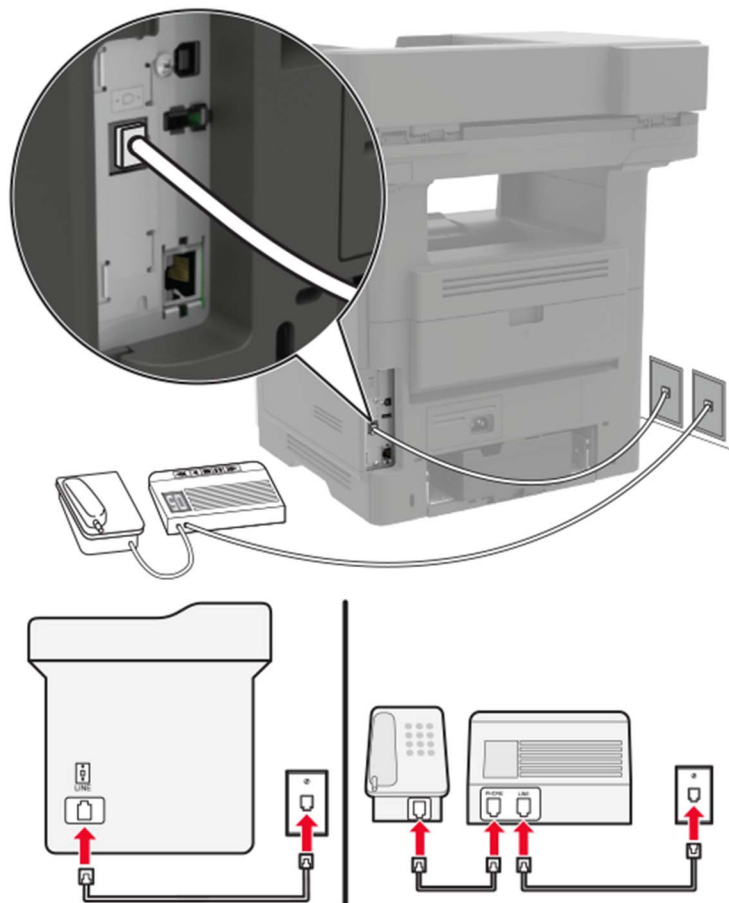

- 1 Connect one end of the telephone cable to the line port of the printer.
- 2 Connect the other end of the cable to an active analog wall jack.

#### Notes:

- If you have only one telephone number on your line, then set the printer to receive faxes automatically.
- Set the printer to pick up calls two rings after the answering machine. For example, if the answering machine picks up calls after four rings, then set the printer Rings to Answer setting to six.

### Setting up fax in countries or regions with different telephone wall jacks and plugs

**⚠ CAUTION—SHOCK HAZARD:** To avoid the risk of electrical shock, do not set up this product or make any electrical or cabling connections, such as the power cord, fax feature, or telephone, during a lightning storm.

**⚠ CAUTION—SHOCK HAZARD:** To avoid the risk of electrical shock, do not use the fax feature during a lightning storm.

**⚠ CAUTION—POTENTIAL INJURY:** To reduce the risk of fire, use only a 26 AWG or larger telecommunications (RJ-11) cord when connecting this product to the public switched telephone network. For users in Australia, the cord must be approved by the Australian Communications and Media Authority.

The standard wall jack adopted by most countries or regions is RJ11. If the wall jack or equipment in your facility is not compatible with this type of connection, then use a telephone adapter. An adapter for your country or region may not come with your printer, and you may need to purchase it separately.

There may be an adapter plug installed in the telephone port of the printer. Do not remove the adapter plug from the telephone port of the printer if you are connecting to a serial or cascaded telephone system.

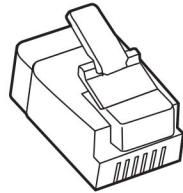

Part name	Part number
Lexmark adapter plug	40X8519

## Connecting the printer to a non-RJ11 wall jack

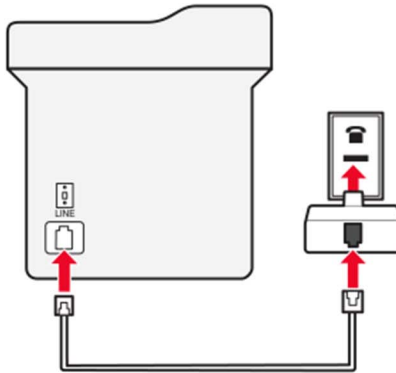
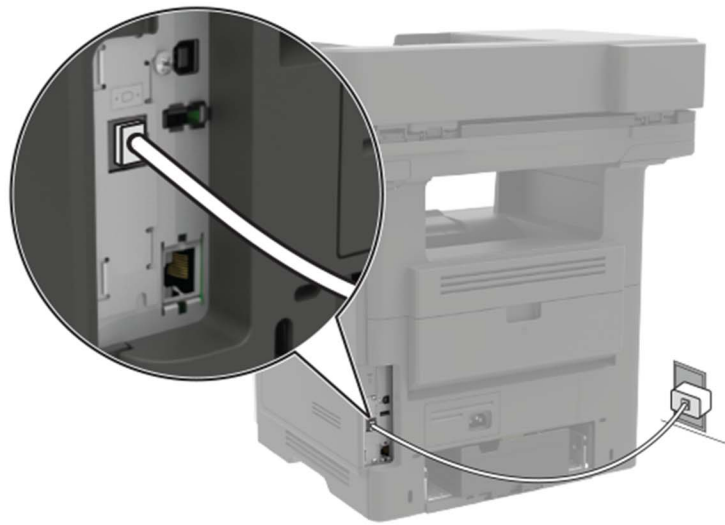

- 1** Connect one end of the telephone cable to the line port of the printer.
- 2** Connect the other end of the cable to the RJ11 adapter, and then connect the adapter to the wall jack.
- 3** If you want to connect another device with a non-RJ11 connector to the same wall jack, then connect it directly to the telephone adapter.



## Connecting the printer to a wall jack in Germany

The German wall jack has two kinds of ports. The N ports are for fax machines, modems, and answering machines. The F port is for telephones. Connect the printer to any of the N ports.

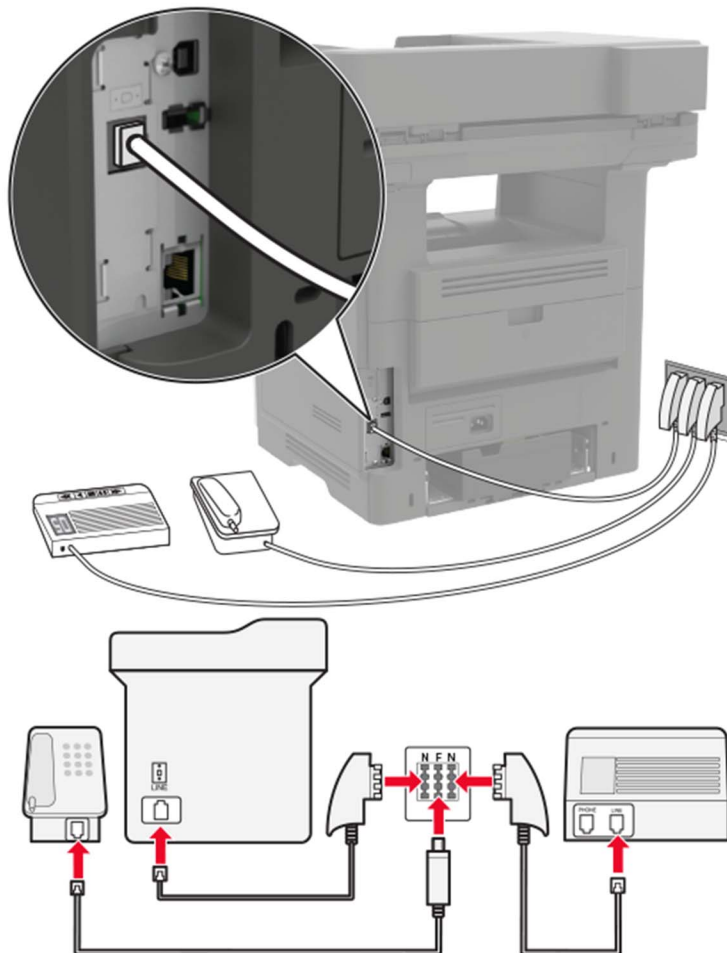

- 1 Connect one end of the telephone cable to the line port of the printer.
- 2 Connect the other end of the cable to the RJ11 adapter, and then connect the adapter to an N port.
- 3 If you want to connect a telephone and answering machine to the same wall jack, then connect the devices as shown.

## Connecting to a distinctive ring service

A distinctive ring service lets you have multiple telephone numbers on one telephone line. Each telephone number is assigned a different ring pattern.

- 1 From the home screen, touch **Settings > Fax > Analog Fax Setup > Fax Receive Settings > Admin Controls > Answer On**.
- 2 Select the ring pattern.
- 3 Apply the changes.

## Setting the fax date and time

- 1 From the home screen, touch **Settings** > **Device** > **Preferences** > **Date and Time** > **Configure**.
- 2 Configure the settings.

## Configuring daylight saving time

- 1 From the home screen, touch **Settings** > **Device** > **Preferences** > **Date and Time** > **Configure**.
- 2 In the Time Zone menu, select **Custom**.
- 3 Configure the settings.

## Sending a fax

### Using the control panel

- 1 Load the original document into the ADF tray or on the scanner glass.
- 2 From the home screen, touch **Fax**, and then enter the needed information.
- 3 If necessary, configure other fax settings.
- 4 Send the fax job.

### Using the computer

**Note:** Make sure that the Universal Fax driver is installed.

#### For Windows users

- 1 With a document open, click **File** > **Print**.
- 2 Select the printer, and then click **Properties**, **Preferences**, **Options**, or **Setup**.
- 3 Click **Fax** > **Enable fax**, and then enter the recipient number.
- 4 If necessary, configure other fax settings.
- 5 Send the fax job.

#### For Macintosh users

- 1 With a document open, choose **File** > **Print**.
- 2 Select the printer and enter the recipient number.
- 3 If necessary, configure other fax settings.
- 4 Send the fax job.

## Scheduling a fax

- 1 Load the original document into the ADF tray or on the scanner glass.
- 2 From the home screen, navigate to:  
**Fax** > enter the fax number > **Send Time**
- 3 Configure the date and time to send the fax.
- 4 If necessary, configure other fax settings.
- 5 Send the fax job.

## Creating a fax destination shortcut

**Note:** You may need administrative rights to create a shortcut.

- 1 Open a web browser, and then type the printer IP address in the address field.

**Notes:**

- View the printer IP address on the home screen. The IP address appears as four sets of numbers separated by periods, such as 123.123.123.123.
- If you are using a proxy server, then temporarily disable it to load the web page correctly.

- 2 Click **Shortcuts** > **Add Shortcut**.
- 3 From the Shortcut Type menu, select **Fax**, and then configure the settings.
- 4 Apply the changes.

## Changing the fax resolution

- 1 Load an original document into the ADF tray or on the scanner glass.
- 2 From the home screen, touch **Fax**, and then enter the needed information.
- 3 Adjust the Resolution setting.
- 4 Send the fax job.

## Adjusting the fax darkness

- 1 Load an original document into the ADF tray or on the scanner glass.
- 2 From the home screen, touch **Fax**, and then enter the needed information.
- 3 Adjust the Darkness setting.
- 4 Send the fax job.

## Viewing a fax log

- 1 Open a Web browser, and then type the printer IP address in the address field.

**Notes:**

- View the printer IP address on the printer home screen. The IP address appears as four sets of numbers separated by periods, such as 123.123.123.123.
- If you are using a proxy server, then temporarily disable it to load the Web page correctly.

**2** Click **Settings > Reports > Fax**.

**3** Click **Fax Job Log** or **Fax Call Log**.

## Blocking junk faxes

**1** From the home screen, touch **Settings > Fax > Analog Fax Setup > Fax Receive Settings > Admin Controls > Block No Name Fax**.

**2** Apply the changes.

## Holding faxes

**1** From the home screen, touch **Settings > Fax > Analog Fax Setup > Fax Receive Settings > Holding Faxes**.

**2** Select a mode.

## Forwarding a fax

**1** From the home screen, touch **Settings > Fax > Analog Fax Setup > Fax Receive Settings > Admin Controls**.

**2** Configure the Fax Forwarding, Forward To, and Forward to Shortcut settings.

**3** Apply the changes.

# Scanning

## Scanning to an FTP server

- 1 Load the original document into the ADF tray or on the scanner glass.
- 2 From the home screen, touch **FTP**, and then enter the needed information.
- 3 If necessary, configure other FTP settings.
- 4 Send the FTP job.

## Creating an FTP shortcut

**Note:** You may need administrative rights to create a shortcut.

- 1 Open a web browser, and then type the printer IP address in the address field.

**Notes:**

- View the printer IP address on the printer home screen. The IP address appears as four sets of numbers separated by periods, such as 123.123.123.123.
- If you are using a proxy server, then temporarily disable it to load the web page correctly.

- 2 Click **Shortcuts > Add Shortcut**.
- 3 From the Shortcut Type menu, select **FTP**, and then configure the settings.
- 4 Apply the changes.

## Scanning to a flash drive

- 1 Load an original document into the ADF tray or on the scanner glass.
- 2 Insert the flash drive.



- 3 Touch **Scan to USB** and adjust the settings if necessary.

**Note:** If the USB Drive screen does not appear, then touch **USB Drive** on the home screen.

- 4 Scan the document.

**Warning—Potential Damage:** To avoid loss of data or printer malfunction, do not touch the flash drive or the printer in the area shown while actively printing, reading, or writing from the memory device.



## Sending scanned documents to a computer

- 1 Load an original document into the ADF tray or on the scanner glass.
- 2 From the home screen, touch **Scan Profiles > Scan To Computer**.
- 3 Select the scan profile where you want to save the document.

# Understanding the printer menus

## Menu map

Device	<ul style="list-style-type: none"> <li>• <a href="#">Preferences</a></li> <li>• <a href="#">Remote Operator Panel</a></li> <li>• <a href="#">Notifications</a></li> <li>• <a href="#">Power Management</a></li> <li>• <a href="#">Information Sent to Lexmark</a></li> </ul>	<ul style="list-style-type: none"> <li>• <a href="#">Accessibility</a></li> <li>• <a href="#">Restore Factory Defaults</a></li> <li>• <a href="#">Maintenance</a></li> <li>• <a href="#">Visible Home Screen Icons</a></li> <li>• <a href="#">About This Printer</a></li> </ul>
Print	<ul style="list-style-type: none"> <li>• <a href="#">Layout</a></li> <li>• <a href="#">Finishing</a></li> <li>• <a href="#">Setup</a></li> <li>• <a href="#">Quality</a></li> <li>• <a href="#">Job Accounting</a></li> <li>• <a href="#">XPS</a></li> </ul>	<ul style="list-style-type: none"> <li>• <a href="#">PDF</a></li> <li>• <a href="#">PostScript</a></li> <li>• <a href="#">PCL</a></li> <li>• <a href="#">HTML</a></li> <li>• <a href="#">Image</a></li> </ul>
Paper	<ul style="list-style-type: none"> <li>• <a href="#">Tray Configuration</a></li> </ul>	<ul style="list-style-type: none"> <li>• <a href="#">Media Configuration</a></li> </ul>
Copy	<a href="#">Copy Defaults</a>	
Fax	<ul style="list-style-type: none"> <li>• <a href="#">Fax Mode</a></li> <li>• <a href="#">Analog Fax Setup</a></li> </ul>	<ul style="list-style-type: none"> <li>• <a href="#">Fax Server Setup</a></li> </ul>
E-mail	<ul style="list-style-type: none"> <li>• <a href="#">E-mail Setup</a></li> <li>• <a href="#">E-mail Defaults</a></li> </ul>	<ul style="list-style-type: none"> <li>• <a href="#">Web Link Setup</a></li> </ul>
FTP	<a href="#">FTP Defaults</a>	
Network/Ports	<ul style="list-style-type: none"> <li>• <a href="#">Network Overview</a></li> <li>• <a href="#">Wireless</a></li> <li>• <a href="#">Ethernet</a></li> <li>• <a href="#">TCP/IP</a></li> <li>• <a href="#">SNMP</a></li> <li>• <a href="#">IPSec</a></li> <li>• <a href="#">802.1x</a></li> </ul>	<ul style="list-style-type: none"> <li>• <a href="#">LPD Configuration</a></li> <li>• <a href="#">HTTP/FTP Settings</a></li> <li>• <a href="#">ThinPrint</a></li> <li>• <a href="#">USB</a></li> <li>• <a href="#">Google Cloud Print</a></li> <li>• <a href="#">Wi-Fi Direct</a></li> </ul>
Security	<ul style="list-style-type: none"> <li>• <a href="#">Login Methods</a></li> <li>• <a href="#">Schedule USB Devices</a></li> <li>• <a href="#">Security Audit Log</a></li> <li>• <a href="#">Login Restrictions</a></li> <li>• <a href="#">Confidential Print Setup</a></li> </ul>	<ul style="list-style-type: none"> <li>• <a href="#">Disk Encryption</a></li> <li>• <a href="#">Erase Temporary Data Files</a></li> <li>• <a href="#">Solutions LDAP Settings</a></li> <li>• <a href="#">Mobile Services Management</a></li> <li>• <a href="#">Miscellaneous</a></li> </ul>
Reports	<ul style="list-style-type: none"> <li>• <a href="#">Menu Settings Page</a></li> <li>• <a href="#">Device</a></li> <li>• <a href="#">Print</a></li> </ul>	<ul style="list-style-type: none"> <li>• <a href="#">Shortcuts</a></li> <li>• <a href="#">Fax</a></li> <li>• <a href="#">Network</a></li> </ul>



<a href="#">Help</a>	<ul style="list-style-type: none"> <li>• Print All Guides</li> <li>• Connection Guide</li> <li>• Copy Guide</li> <li>• E-mail Guide</li> <li>• Fax Guide</li> <li>• FTP Guide</li> </ul>	<ul style="list-style-type: none"> <li>• Information Guide</li> <li>• Media Guide</li> <li>• Mono Quality Guide</li> <li>• Moving Guide</li> <li>• Print Quality Guide</li> <li>• Supplies Guide</li> </ul>
<a href="#">Troubleshooting</a>	<ul style="list-style-type: none"> <li>• Print Quality Test Pages</li> </ul>	<ul style="list-style-type: none"> <li>• Cleaning the scanner</li> </ul>

## Device

### Preferences

Menu item	Description
<b>Display Language</b> [List of languages]	Set the language of the text that appears on the display.
<b>Country/Region</b> [List of countries or regions]	Identify the country or region where the printer is configured to operate.
<b>Run initial setup</b> On Off*	Run the setup wizard.
<b>Keyboard</b> Keyboard Type [List of languages]	Select a language as a keyboard type.  <b>Notes:</b> <ul style="list-style-type: none"> <li>• All the Keyboard Type values may not appear or may require special hardware to appear.</li> <li>• This menu item appears only in some printer models.</li> </ul>
<b>Displayed information</b> Display Text 1 [IP Address*] Display Text 2 [Date/Time*] Custom Text 1 Custom Text 2	Specify the information to appear on the home screen.  <b>Note:</b> Custom Text 1 and Custom Text 2 appear only in some printer models.
<b>Date and Time</b> Configure Current Date and Time Manually Set Date and Time Date Format [MM-DD-YYYY*] Time Format [12 hour A.M./P.M.*] Time Zone [GMT*]	Configure the printer date and time.
<b>Note:</b> An asterisk (*) next to a value indicates the factory default setting.	

Menu item	Description
<b>Date and Time</b> Network Time Protocol Enable NTP [On*] NTP Server Enable Authentication	Configure the settings for Network Time Protocol (NTP). <b>Notes:</b> <ul style="list-style-type: none"> <li>• Enable Authentication appears only in some printer models.</li> <li>• When Enable Authentication is set to MD5 key, Key ID and Password appear.</li> </ul>
<b>Paper Sizes</b> U.S.* Metric	Specify the unit of measurement for paper sizes. <b>Note:</b> The country or region selected in the initial setup wizard determines the initial paper size setting.
<b>Screen Brightness</b> 20–100% (100*)	Adjust the brightness of the display. <b>Note:</b> This menu item appears only in some printer models.
<b>Flash Drive Access</b> Enabled* Disabled	Enable access to the flash drive.
<b>Allow Background Removal</b> On* Off	Specify whether background removal is allowed.
<b>Allow Custom Job scans</b> On* Off	Scan multiple jobs to one file.
<b>One Page Flatbed Scanning</b> On Off*	Set copies from the scanner glass to only one page at a time.
<b>Audio Feedback</b> Button Feedback On* Off	Enable audio feedback for button presses, panel interactions, paper loaded prompts, and error notifications. <b>Note:</b> This menu item appears only in some printer models.
<b>Audio Feedback</b> Volume 1–10 (5*)	Adjust the volume of the printer speakers. <b>Notes:</b> <ul style="list-style-type: none"> <li>• Changes to the volume are applied after the current user session ends.</li> <li>• This menu item appears only in some printer models.</li> </ul>
<b>Screen Timeout</b> 10–300 (60*)	Set the idle time in seconds before the display shows the home screen, or before the printer logs off a user account automatically.
<b>Note:</b> An asterisk (*) next to a value indicates the factory default setting.	

## Remote Operator Panel

Menu item	Description
<b>External VNC Connection</b> Don't Allow* Allow	Connect an external Virtual Network Computing (VNC) client to the remote control panel.
<b>Authentication Type</b> None* Standard Authentication	Set the authentication type when accessing the VNC client server.  <b>Note:</b> When set to Standard Authentication, VNC Password appears.
<b>Note:</b> An asterisk (*) next to a value indicates the factory default setting.	

## Notifications

Menu item	Description
<b>Error Lighting</b> Off On*	Set the indicator light to come on when a printer error occurs.  <b>Note:</b> This menu item appears only in some printer models.
<b>ADF Loaded Beep</b> Off On*	Enable a sound when loading paper into the ADF.
<b>Alarm Control</b> Off Single* Continuous	Set the number of times that the alarm sounds when the printer requires user intervention.
<b>Supplies</b> Show Supply Estimates Show estimates* Do not show estimates	Show the estimated status of the supplies.
<b>Supplies</b> Cartridge Alarm Off* Single Continuous	Set the number of times that the alarm sounds when the toner cartridge is low.
<b>E-mail Alerts Setup</b>	Configure the printer to send e-mail alerts to a list of contacts when the printer requires user intervention.
<b>Error Prevention</b> Jam Assist Off On*	Set the printer to flush automatically blank pages or pages with partial prints after a jammed page is cleared.
<b>Note:</b> An asterisk (*) next to a value indicates the factory default setting.	

Menu item	Description
<b>Error Prevention</b> Auto Continue Disabled 5–255 (5*)	Let the printer to continue processing or printing a job automatically after clearing certain attendance conditions.
<b>Error Prevention</b> Auto Reboot Auto Reboot Reboot when idle Reboot always* Reboot never	Set the printer to restart when an error occurs.
<b>Error Prevention</b> Auto Reboot Max Auto Reboots 1–20 (2*)	Set the number of automatic reboots that the printer can perform.
<b>Error Prevention</b> Auto Reboot Auto Reboot Window 1–525600 (720*)	Set the number of seconds before the printer performs an automatic reboot.
<b>Error Prevention</b> Auto Reboot Auto Reboot Counter	Show a read-only information of the reboot counter.
<b>Error Prevention</b> Auto Reboot Reset Auto Reboot Counter Cancel Continue	Reset Auto Reboot Counter.
<b>Error Prevention</b> Display Short Paper Error On Auto-clear*	Set the printer to show a message when a short paper error occurs. <b>Note:</b> Short paper refers to the size of the paper loaded.
<b>Error Prevention</b> Page Protect Off* On	Set the printer to process the entire page into the memory before printing it.
<b>Jam Content Recovery</b> Jam Recovery Off On Auto*	Set the printer to reprint jammed pages.
<b>Note:</b> An asterisk (*) next to a value indicates the factory default setting.	

Menu item	Description
<b>Jam Content Recovery</b> Scanner Jam Recovery Job level Page level*	Specify how to restart a scan job after resolving a paper jam.
<b>Note:</b> An asterisk (*) next to a value indicates the factory default setting.	

## Power Management

Menu item	Description
<b>Sleep Mode Profile</b> Print With Display Off Display on when printing Allow printing with display off*	Allow printing with the display turned off.
<b>Timeouts</b> Sleep Mode 1–120 minutes (15*)	Set the idle time before the printer begins operating in Sleep mode.
<b>Timeouts</b> Hibernate Timeout Disabled 1 hour 2 hours 3 hours 6 hours 1 day 2 days 3 days* 1 week 2 weeks 1 month	Set the time before the printer enters Hibernate mode.
<b>Timeouts</b> Hibernate Timeout on Connection Hibernate Do Not Hibernate*	Set the printer to Hibernate mode even when an active Ethernet connection exists.
<b>Eco-Mode</b> Off* Energy Energy/Paper Paper	Minimize the use of energy, paper, or specialty media. <b>Note:</b> Setting Eco-Mode to Energy or Paper may affect printer performance, but not print quality.
<b>Schedule Power Modes</b> Schedules	Schedule the printer when to enter Sleep or Hibernate mode. <b>Note:</b> This menu item appears only in some printer models.
<b>Note:</b> An asterisk (*) next to a value indicates the factory default setting.	

## Information Sent to Lexmark

Menu item	Description
<b>Information Sent to Lexmark</b> Save Supplies and Page Usage (Anonymous) Device Performance (Anonymous) Device Interaction (Anonymous) None of the Above* More Information	Send printer usage and performance information to Lexmark. <b>Note:</b> Information Send Time and User Information - Level appear only when you select any of the settings in Information Sent to Lexmark, except None of the Above.
<b>Information Send Time</b> Start Time Stop Time	
<b>User Information - Level</b> Anonymous Session Information Only* Session Information with Generic User Information Session Information with Actual User IDs	
<b>Note:</b> An asterisk (*) next to a value indicates the factory default setting.	

## Accessibility

**Note:** This menu appears only in some printer models.

Menu item	Description
<b>Duplicate Key Strike Interval</b> 0–5 (0*)	Set the interval in seconds during which the printer ignores duplicate key presses on an attached keyboard.
<b>Key Repeat Initial Delay</b> 0.25–5 (1*)	Set the initial length of delay in seconds before a repeating key starts repeating. <b>Note:</b> This menu item appears only when a keyboard is attached to the printer.
<b>Key Repeat Rate</b> 0.5–30 (30*)	Set the number of presses per second for a repeating key. <b>Note:</b> This menu item appears only when a keyboard is attached to the printer.
<b>Prolong Screen Timeout</b> Off* On	Let the user remain in the same location and reset the Screen Timeout timer when it expires instead of returning to the home screen.
<b>Headphone Volume</b> 1–10 (5*)	Adjust the headphone volume. <b>Note:</b> This menu item appears only when a headphone is attached to the printer.
<b>Note:</b> An asterisk (*) next to a value indicates the factory default setting.	

Menu item	Description
<b>Enable Voice Guidance When Headphone Is Attached</b> Off* On	Enable Voice Guidance when a headphone is attached to the printer.
<b>Speak Passwords/PINs</b> Off* On	Set the printer to read out loud passwords or personal identification numbers. <b>Note:</b> This menu item appears only when a headphone or a speaker is attached to the printer.
<b>Speech Rate</b> Very Slow Slow Normal* Fast Faster Very Fast Rapid Very Rapid Fastest	Set the Voice Guidance speech rate. <b>Note:</b> This menu item appears only when a headphone or a speaker is attached to the printer.
<b>Note:</b> An asterisk (*) next to a value indicates the factory default setting.	

## Restore Factory Defaults

Menu item	Description
<b>Restore Settings</b> Restore all settings Restore printer settings Restore network settings Restore fax settings Restore app settings	Restore the printer factory default settings. <b>Note:</b> The default value is the value selected during the initial setup.

## Maintenance

### Configuration Menu

Menu item	Description
<b>USB Configuration</b> USB PnP 1* 2	Change the USB driver mode of the printer to improve its compatibility with a personal computer.
<b>Note:</b> An asterisk (*) next to a value indicates the factory default setting.	

Menu item	Description
<b>USB Configuration</b> USB Scan to Local On* Off	Set whether the USB device driver enumerates as a USB Simple device (single interface) or as a USB Composite device (multiple interfaces).
<b>USB Configuration</b> USB Speed Full Auto*	Set the USB port to run at full speed and disable its high-speed capabilities.
<b>Tray Configuration</b> Tray Linking Automatic* Off	Set the printer to link the trays that have the same paper type and paper size settings.
<b>Tray Configuration</b> Show Tray Insert Message Off Only for unknown sizes* Always	Show the <b>Tray Insert</b> message.
<b>Tray Configuration</b> A5 Loading Short Edge* Long Edge	Specify the page orientation when loading A5-size paper.
<b>Tray Configuration</b> Paper Prompts Auto* Multipurpose Feeder Manual Paper Envelope Prompts Auto* Multipurpose Feeder Manual Envelope	Set the paper source that the user fills when a prompt to load paper or envelope appears.  <b>Note:</b> For Multipurpose Feeder to appear, set Configure MP to Cassette from the Paper menu.
<b>Tray Configuration</b> Action for Prompts Prompt user* Continue Use current	Set the printer to resolve paper- or envelope-related change prompts.
<b>Reports</b> Menu Settings Page Event Log Event Log Summary	Print reports about printer menu settings, status, and event logs.

**Note:** An asterisk (\*) next to a value indicates the factory default setting.



Menu item	Description
<b>Supply Usage And Counters</b> Clear Supply Usage History Reset Black Cartridge Counter Reset Black Imaging Unit Counter Reset Maintenance Counter	Reset the supply page counter or view the total printed pages.
<b>Printer Emulations</b> PPDS Emulation Off* On	Set the printer to recognize and use the PPDS data stream.
<b>Fax Configuration</b> Fax Low Power Support Disable Sleep Permit Sleep Auto*	Set the fax chip to enter low-power mode whenever the printer determines that it should.
<b>Print Configuration</b> Font Sharpening 0–150(24*)	Set a text point-size value below which the high-frequency screens are used when printing font data. For example, if the value is 24, then all fonts sized 24 points or less use the high-frequency screens.
<b>Print Configuration</b> Print Density 1–5 (3*) Copy Density 1–5 (3*)	Adjust the toner density when printing or copying documents.
<b>Device Operations</b> Quiet Mode Off* On	Set the printer to operate in Quiet Mode.
<b>Device Operations</b> Panel Menus Enable* Disable	Enable access to the control panel menus.
<b>Device Operations</b> Safe Mode Off* On	Set the printer to operate in a special mode, in which it attempts to continue offering as much functionality as possible, despite known issues. For example, when set to On and the duplex motor is nonfunctional, the printer performs one-sided printing for a two-sided print job.
<b>Note:</b> An asterisk (*) next to a value indicates the factory default setting.	

Menu item	Description
<b>Device Operations</b> Minimum Copy Memory 20MB* 30MB 50MB 80MB 100MB	Set the memory allocation for storing copy jobs. <b>Note:</b> The values appear only if the amount of installed DRAM is at least twice the amount of the value.
<b>Device Operations</b> Clear Custom Status	Erase user-defined strings for the Default or Alternate custom messages.
<b>Device Operations</b> Clear all remotely-installed messages	Erase messages that were remotely installed.
<b>Device Operations</b> Automatically Display Error Screens On* Off	Show existing error messages on the display after the printer remains inactive on the home screen for a length of time equal to the Screen Timeout setting.
<b>Device Operations</b> Honor orientation on fast path copy Off* On	Enable the printer to use the Orientation setting under the Copy menu when sending quick copy jobs.
<b>Scanner Configuration</b> Scanner Manual Registration Front ADF Registration Rear ADF Registration Flatbed Registration	Manually register the flatbed and ADF after replacing the ADF, scanner glass, or controller board.
<b>Scanner Configuration</b> Edge Erase ADF Edge Erase 0–6 (3*) Flatbed Edge Erase 0–6 (3*)	Set the size, in millimeters, of the no-print area around an ADF or flatbed scan job.
<b>Scanner Configuration</b> Disable Scanner Enabled* Disabled ADF Disabled	Disable the scanner if it is not working properly.
<b>Scanner Configuration</b> Scanner Manual Registration Print Quick Test	Print a test page that shows the scanner margin settings.
<b>Note:</b> An asterisk (*) next to a value indicates the factory default setting.	

Menu item	Description
<b>Scanner Configuration</b> Tiff Byte Order CPU Endianness* Little Endian Big Endian	Determine the byte order of a TIFF-formatted scan output.
<b>Scanner Configuration</b> Exact Tiff Rows Per Strip On* Off	Set the RowsPerStrip tag value of a TIFF-formatted scan output.
<b>Note:</b> An asterisk (*) next to a value indicates the factory default setting.	

### Out of Service Erase

Menu item	Description
<b>Out of Service Erase</b> Memory Last Sanitized Hard Disk Last Sanitized	Show information on when the printer memory or hard disk was last sanitized.  <b>Note:</b> Hard Disk Last Sanitized appears only in printers with a hard disk installed.
<b>Out of Service Erase</b> Sanitize all information on nonvolatile memory Sanitize all information on hard disk Erase all printer and network settings	Clear all settings and applications that are stored in the printer memory or hard disk.  <b>Note:</b> Sanitize all information on hard disk appears only in printers with a hard disk installed.

### Visible Home Screen Icons

Menu	Description
<b>Visible Home Screen Icons</b> Copy E-mail Fax Status/Supplies Job Queue Change Language Address Book Bookmarks Held Jobs USB FTP Scan Profiles App Profiles Scan Center	Specify which icons to show on the home screen.  <b>Note:</b> The icons may vary depending on your home screen customization settings, administrative setup, and active embedded solutions.

## About this Printer

Menu item	Description
<b>Asset Tag</b>	Show the serial number of the printer.
<b>Printer's Location</b>	Identify the printer location. Maximum length is 63 characters.
<b>Contact</b>	Personalize the printer name. Maximum length is 63 characters.
<b>Export Configuration File to USB</b>	Export configuration files to a flash drive.
<b>Export Compressed Logs to USB</b>	Export compressed log files to a flash drive.

## Print

### Layout

Menu item	Description
<b>Sides</b> 1-sided* 2-sided	Specify whether to print on one side or two sides of the paper.
<b>Flip Style</b> Long Edge* Short Edge	Determine which side of the paper (long edge or short edge) is bound when performing two-sided printing.  <b>Note:</b> Depending on the option selected, the printer automatically offsets each printed information of the page to bind the job correctly.
<b>Blank Pages</b> Print Do Not Print*	Print blank pages that are included in a print job.
<b>Collate</b> Off [1,1,1,2,2,2]* On [1,2,1,2,1,2]	Keep the pages of a print job stacked in sequence, particularly when printing multiple copies of the job.
<b>Separator Sheets</b> None* Between Copies Between Jobs Between Pages	Insert blank separator sheets when printing.
<b>Separator Sheet Source</b> Tray [x] (1*) Multipurpose Feeder	Specify the paper source for the separator sheet.  <b>Note:</b> The multipurpose feeder is available only in some printer models.
<b>Note:</b> An asterisk (*) next to a value indicates the factory default setting.	

Menu item	Description
<b>Pages per Side</b> Off* 2 pages per side 3 pages per side 4 pages per side 6 pages per side 9 pages per side 12 pages per side 16 pages per side	Print multiple page images on one side of a sheet of paper.
<b>Pages per Side Ordering</b> Horizontal* Reverse Horizontal Vertical Reverse Vertical	Specify the positioning of multiple page images when using Pages per Side. <b>Note:</b> The positioning depends on the number of page images and their page orientation.
<b>Pages per Side Orientation</b> Auto* Landscape Portrait	Specify the orientation of a multiple-page document when using Pages per Side.
<b>Pages per Side Border</b> None* Solid	Print a border around each page image when using Pages per Side.
<b>Copies</b> 1–9999 (1*)	Specify the number of copies for each print job.
<b>Print Area</b> Normal* Fit to page Whole Page	Set the printable area on a sheet of paper.
<b>Note:</b> An asterisk (*) next to a value indicates the factory default setting.	

## Finishing

Menu item	Description
<b>Staple Job</b> Off* 1 staple, top left corner 2 staples, left 1 staple, top right corner 2 staples, top 1 staple, bottom left corner 2 staples, bottom 1 staple, bottom right corner 2 staples, right	Specify the staple position for all print jobs. <b>Note:</b> This menu item appears only when a staple finisher is installed.
<b>Staple Test</b> Start	Determine whether the staple finisher is functioning properly. <b>Note:</b> This menu item appears only when a staple finisher is installed.
<b>Hole Punch</b> Off* On	Punch holes along the edge of the printed output. <b>Note:</b> This menu item appears only when a staple, hole punch finisher is installed.
<b>Hole Punch Mode</b> 2 holes 3 holes 4 holes	Set the hole punch mode for the printed output. <b>Notes:</b> <ul style="list-style-type: none"> <li>• 3 holes is the U.S. factory default setting. 4 holes is the international factory default setting.</li> <li>• This menu item appears only when a staple, hole punch finisher is installed.</li> </ul>
<b>Offset Pages</b> None* Between Copies Between Jobs	Offset the output of each print job or each copy of a print job. <b>Notes:</b> <ul style="list-style-type: none"> <li>• Between Copies offsets each copy of a print job if Collate is set to On [1,2,1,2,1,2]. If Collate is set to Off [1,1,2,2,2], then each set of printed pages are offset, such as all page 1s and all page 2s.</li> <li>• Between Jobs sets the same offset position for the entire print job regardless of the number of copies printed.</li> <li>• This menu item appears only when a staple finisher is installed.</li> </ul>
<b>Note:</b> An asterisk (*) next to a value indicates the factory default setting.	

## Setup

Menu item	Description
<b>Printer Language</b> PCL Emulation PS Emulation*	Set the printer language. <b>Note:</b> Setting a printer language default does not prevent a software program from sending print jobs that use another printer language.
<b>Note:</b> An asterisk (*) next to a value indicates the factory default setting.	

Menu item	Description
<b>Job Waiting</b> Off* On	Preserve print jobs requiring supplies so that jobs not requiring the missing supplies can print. <b>Note:</b> This menu item appears only when a printer hard disk is installed.
<b>Job Hold Timeout</b> 0–255 (30*)	Set the time in seconds that the printer waits for user intervention before it holds jobs that require unavailable resources and continues to print other jobs in the print queue. <b>Note:</b> This menu item appears only when a printer hard disk is installed.
<b>Download Target</b> RAM* Disk	Specify where to save all permanent resources, such as fonts and macros, that have been downloaded to the printer. <b>Note:</b> This menu item appears only when a printer hard disk is installed.
<b>Resource Save</b> Off* On	Determine what the printer does with downloaded resources, such as fonts and macros, when it receives a job that requires more than the available memory. <b>Notes:</b> <ul style="list-style-type: none"> <li>• When set to Off, the printer retains downloaded resources only until memory is needed. Resources associated with the inactive printer language are deleted.</li> <li>• When set to On, the printer preserves all the permanent downloaded resources across all language switches. When necessary, the printer shows memory full messages instead of deleting permanent resources.</li> </ul>
<b>Print All Order</b> Alphabetical* Newest First Oldest First	Specify the order in which held and confidential jobs are printed when Print All is selected. <b>Note:</b> This menu item appears only when a printer hard disk is installed.
<b>Note:</b> An asterisk (*) next to a value indicates the factory default setting.	

## Quality

Menu item	Description
<b>Print Resolution</b> 600 dpi* 1200 Image Q 2400 Image Q 1200 dpi 300 dpi	Set the resolution for the text and images on the printed output. <b>Note:</b> Resolution is determined in dots per inch or image quality.
<b>Pixel Boost</b> Off* Fonts Horizontally Vertically Both directions	Enable more pixels to print in clusters for clarity, in order to enhance text and images.
<b>Note:</b> An asterisk (*) next to a value indicates the factory default setting.	

Menu item	Description
<b>Toner Darkness</b> 1–10 (8*)	Determine the lightness or darkness of text images.
<b>Halftone</b> Normal* Detail	Enhance the printed output to have smoother lines with sharper edges.
<b>Brightness</b> -6 to 6 (0*)	Adjust the brightness of the printed output.
<b>Contrast</b> 0 to 5 (0*)	Adjust the contrast of the printed output.
<b>Gray Correction</b> Off Auto*	Adjust the contrast enhancement applied to images.

**Note:** An asterisk (\*) next to a value indicates the factory default setting.

## Job Accounting

**Note:** This menu appears only when a printer hard disk is installed.

Menu item	Description
<b>Job Accounting</b> Off* On	Set the printer to create a log of the print jobs that it receives.
<b>Accounting Log Frequency</b> Daily Weekly Monthly*	Specify how often the printer creates a log file.
<b>Log Action at End of Frequency</b> None* E-mail Current Log E-mail & Delete Current Log Post Current Log Post & Delete Current Log	Specify how the printer responds when the frequency threshold expires. <b>Note:</b> The value defined in Accounting Log Frequency determines when this action is triggered.
<b>Log Near Full Level</b> Off* On	Specify the maximum size of the log file before the printer executes the Log Action at Near Full.

**Note:** An asterisk (\*) next to a value indicates the factory default setting.



Menu item	Description
<b>Log Action at Near Full</b> None* E-mail Current Log E-mail & Delete Current Log E-mail & Delete Oldest Log Post Current Log Post & Delete Current Log Post & Delete Oldest Log Delete Current Log Delete Oldest Log Delete All But Current Delete All Logs	Specify how the printer responds when the hard disk is nearly full. <b>Note:</b> The value defined in Log Near Full Level determines when this action is triggered.
<b>Log Action at Full</b> None* E-mail & Delete Current Log E-mail & Delete Oldest Log Post & Delete Current Log Post & Delete Oldest Log Delete Current Log Delete Oldest Log Delete All But Current Delete All Logs	Specify how the printer responds when disk usage reaches the maximum limit (100MB).
<b>URL to Post Log</b>	Specify where the printer posts job accounting logs.
<b>E-mail Address to Send Logs</b>	Specify the e-mail address to which the printer sends job accounting logs.
<b>Log File Prefix</b>	Specify the prefix for the log file name. <b>Note:</b> The current host name defined in the TCP/IP menu is used as the default log file prefix.
<b>Note:</b> An asterisk (*) next to a value indicates the factory default setting.	

## XPS

Menu item	Description
<b>Print Error Pages</b> Off* On	Print a test page that contains information on errors, including XML markup errors.
<b>Minimum Line Width</b> 1–30 (2*)	Set the minimum stroke width of any job printed in 1200 dpi.
<b>Note:</b> An asterisk (*) next to a value indicates the factory default setting.	

## PDF

Menu item	Description
<b>Scale to Fit</b> Off* On	Scale the page content to fit the selected paper size.
<b>Annotations</b> Do Not Print* Print	Specify whether to print annotations in the PDF.
<b>Note:</b> An asterisk (*) next to a value indicates the factory default setting.	

## PostScript

Menu item	Description
<b>Print PS Error</b> On Off*	Print a test page that contains the PostScript error.
<b>Minimum Line Width</b> 1–30 (2*)	Set the minimum stroke width of any job printed in 1200 dpi.
<b>Lock PS Startup Mode</b> On Off*	Disable the SysStart file.
<b>Font Priority</b> Resident* Flash/Disk	Establish the font search order. <b>Notes:</b> <ul style="list-style-type: none"> <li>Resident sets the printer to search its memory for the requested font before searching the flash memory.</li> <li>Flash/Disk sets the printer to search the flash memory for the requested font before searching the printer memory.</li> <li>This menu item appears only when a flash memory is installed.</li> </ul>
<b>Wait Timeout</b> Disabled 15–65535 (40*)	Set the printer to wait for additional data before canceling a print job.
<b>Note:</b> An asterisk (*) next to a value indicates the factory default setting.	

## PCL

Menu item	Description
<b>Font Source</b> Resident* Disk Download Flash All	Choose the source which contains the default font selection.  <b>Notes:</b> <ul style="list-style-type: none"> <li>Flash and Disk appear only in some printer models.</li> <li>For Flash and Disk to appear, make sure that they are not read- or write-protected.</li> </ul>
<b>Font Name</b> [List of available fonts]	Select a font from the specified font source.
<b>Symbol Set</b> [List of available symbol set]	Specify the symbol set for each font name.  <b>Note:</b> A symbol set is a set of alphabetic and numeric characters, punctuation, and special symbols. Symbol sets support the different languages or specific programs such as math symbols for scientific text.
<b>Pitch</b> 0.08–100 (10*)	Specify the font pitch for scalable monospaced fonts.  <b>Note:</b> Pitch refers to the number of fixed-space characters in a horizontal inch of type.
<b>Orientation</b> Portrait* Landscape	Specify the orientation of text and graphics on the page.
<b>Lines per Page</b> 1–255	Specify the number of lines of text for each page printed through the PCL® datastream.  <b>Notes:</b> <ul style="list-style-type: none"> <li>This menu item activates vertical escapement that causes the selected number of requested lines to print between the default margins of the page.</li> <li>60 is the U.S. factory default setting. 64 is the international factory default setting.</li> </ul>
<b>PCL5 Minimum Line Width</b> 1–30 (2*)	Set the initial minimum stroke width.  <b>Notes:</b>
<b>PCLXL Minimum Line Width</b> 1–30 (2*)	<ul style="list-style-type: none"> <li>Jobs printed in 1200 dpi use the value directly.</li> <li>Jobs printed in 4800CQ use half the value.</li> </ul>
<b>A4 Width</b> 198 mm* 203 mm	Set the width of the logical page on A4-size paper.  <b>Note:</b> Logical page is the space on the physical page where data is printed.
<b>Auto CR after LF</b> Off* On	Set the printer to perform a carriage return after a line feed control command.  <b>Note:</b> Carriage return is a mechanism that commands the printer to move the position of the cursor to the first position on the same line.
<b>Note:</b> An asterisk (*) next to a value indicates the factory default setting.	

Menu item	Description
<b>Auto LF after CR</b> Off* On	Set the printer to perform a line feed after a carriage return control command.
<b>Tray Renumber</b> Assign MP Feeder Off* None 0–201 Assign Tray [x] Off* None 0–201 Assign Manual Paper Off* None 0–201 Assign Manual Envelope Off* None 0–201	Configure the printer to work with print drivers or applications that use different source assignments for the paper source.
<b>Tray Renumber</b> View Factory Defaults Restore Defaults	Show the factory default setting assigned for each paper source.
<b>Tray Renumber</b> Restore Defaults	Return all tray assignments to factory default values.
<b>Print Timeout</b> Disabled 1–255 (90*)	Set the printer to end a print job after it has been idle for the specified amount of time in seconds.
<b>Note:</b> An asterisk (*) next to a value indicates the factory default setting.	

## HTML

Menu item	Description
<b>Font Name</b> [List of fonts] (Times*)	Set the font to use for HTML documents.
<b>Font Size</b> 1–255 (12*)	Set the font size to use for HTML documents.
<b>Scale</b> 1–400% (100*)	Scale HTML documents.
<b>Note:</b> An asterisk (*) next to a value indicates the factory default setting.	

Menu item	Description
<b>Orientation</b> Portrait* Landscape	Set the page orientation for HTML documents.
<b>Margin Size</b> 8–255 mm (19*)	Set the page margin for HTML documents.
<b>Backgrounds</b> Do Not Print Print*	Print background information or graphics for HTML documents.
<b>Note:</b> An asterisk (*) next to a value indicates the factory default setting.	

## Image

Menu item	Description
<b>Auto Fit</b> On Off*	Select the best available paper size and orientation setting for an image. <b>Note:</b> When set to On, this menu item overrides the scaling and orientation settings for the image.
<b>Invert</b> Off* On	Invert bitonal monochrome images. <b>Note:</b> This menu item does not apply to GIF or JPEG image formats.
<b>Scaling</b> Anchor Top Left Best Fit* Anchor Center Fit Height/Width Fit Height Fit Width	Adjust the image to fit the printable area. <b>Note:</b> When Auto Fit is set to On, Scaling is automatically set to Best Fit.
<b>Orientation</b> Portrait* Landscape Reverse Portrait Reverse Landscape	Specify the orientation of text and graphics on the page.
<b>Note:</b> An asterisk (*) next to a value indicates the factory default setting.	

# Paper

## Tray Configuration

Menu item	Description
<b>Default Source</b> Tray [x] (1*) Multipurpose Feeder Manual Paper Manual Envelope	Set the paper source for all print jobs.  <b>Note:</b> Multipurpose Feeder appears only when Configure MP is set to Cassette.
<b>Paper Size/Type</b> Tray [x] Multipurpose Feeder Manual Paper Manual Envelope	Specify the paper size or paper type loaded in each paper source.
<b>Configure MP</b> Cassette* Manual First	Set the printer when to pick paper from the multipurpose feeder.  <b>Notes:</b> <ul style="list-style-type: none"> <li>• When set to Cassette, the printer treats the multipurpose feeder like a tray.</li> <li>• When set to Manual, the printer treats the multipurpose feeder like a manual feeder.</li> <li>• When set to First, the printer picks paper from the multipurpose feeder until it is empty, regardless of the required paper source or paper size.</li> </ul>
<b>Substitute Size</b> Off Statement/A5 Letter/A4 All Listed*	Set the printer to substitute a specified paper size if the requested size is not loaded in any paper source.  <b>Notes:</b> <ul style="list-style-type: none"> <li>• Off prompts the user to load the required paper size.</li> <li>• Statement/A5 prints A5-size document on statement when loading statement and statement-size jobs on A5 paper size when loading A5.</li> <li>• Letter/A4 prints A4-size document on letter when loading letter and letter-size jobs on A4 paper size when loading letter.</li> <li>• All Listed substitutes Letter/A4.</li> </ul>
<b>Note:</b> An asterisk (*) next to a value indicates the factory default setting.	

## Media Configuration

### Universal Setup

Menu item	Description
<b>Units of Measure</b> Inches Millimeters	Specify the unit of measurement for the universal paper. <b>Note:</b> Inches is the U.S. factory default setting. Millimeters is the international factory default setting.
<b>Portrait Width</b> 3–14.17 inches (8.50*) 76–359.91 mm (216*)	Set the portrait width of the universal paper.
<b>Portrait Height</b> 3–14.17 inches (14*) 76–359.91 mm (356*)	Set the portrait height of the universal paper.
<b>Feed Direction</b> Short Edge* Long Edge	Set the printer to pick paper from the short edge or long edge direction. <b>Note:</b> Long Edge appears only when the longest edge is shorter than the maximum width supported.
<b>Note:</b> An asterisk (*) next to a value indicates the factory default setting.	

### Custom Scan Sizes

Menu item	Description
<b>Custom Scan Size [x]</b> Scan Size Name Width 1–8.50 inches (8.50*) 25–216 mm (216*) Height 1–14 inches (14*) 25–356 mm (297*) Orientation Portrait* Landscape 2 scans per side Off* On	Assign a scan size name and configure the scan settings.

## Media Types

Menu item	Description
Plain	Specify the texture and weight of the paper loaded. Select from the following options: Paper Texture Smooth Normal* Rough Paper Weight Light Normal* Heavy
Card Stock	
Transparency	
Recycled	
Labels	
Bond	
Envelope	
Rough Envelope	
Letterhead	
Preprinted	
Colored Paper	
Light	
Heavy	
Rough/Cotton	
Custom Type [x]	

**Note:** An asterisk (\*) next to a value indicates the factory default setting.

## Copy

### Copy Defaults

Menu item	Description
<b>Content Type</b> Text Text/Photo* Photo Graphics	Improve the output result based on the content of the original document.
<b>Content Source</b> Black and White Laser* Color Laser Inkjet Photo/Film Magazine Newspaper Press Other	Improve the output result based on the source of the original document.

**Note:** An asterisk (\*) next to a value indicates the factory default setting.



Menu item	Description
<b>Sides</b> 1 sided to 1 sided* 1 sided to 2 sided 2 sided to 1 sided 2 sided to 2 sided	Specify the scanning behavior based on the original document.
<b>Separator Sheets</b> None* Between Copies Between Jobs Between Pages	Specify whether to insert blank separator sheets when printing.
<b>Separator Sheet Source</b> Tray [x] (1*) Multipurpose Feeder	Specify the paper source for the separator sheet.
<b>Pages per Side</b> Off* 2 Portrait pages 4 Portrait pages 2 Landscape pages 4 Landscape pages	Specify the number of page images to print on one side of a sheet of paper.
<b>Print Page Borders</b> Off* On	Place a border around each image when printing multiple pages on a single page.
<b>Collate</b> Off [1,1,1,2,2,2] On [1,2,1,2,1,2]*	Print multiple copies in sequence.
<b>“Copy from” Size</b> [List of paper sizes]	Set the paper size of the original document.  <b>Notes:</b> <ul style="list-style-type: none"> <li>• Letter is the U.S. factory default setting. A4 is the international factory default setting.</li> <li>• This menu item may vary depending on your printer model.</li> </ul>
<b>“Copy to” Source</b> Tray [x] (1*) Multipurpose Feeder Auto Size Match	Specify the paper source for the copy job.
<b>Darkness</b> -4 to 4 (0*)	Adjust the darkness of the scanned image.
<b>Number of Copies</b> 1–9999 (1*)	Specify the number of copies.
<b>Note:</b> An asterisk (*) next to a value indicates the factory default setting.	

Menu item	Description
<b>Header/Footer</b> Top left Top middle Top right Bottom left Bottom middle Bottom right	Apply a header or footer on the printed output.
<b>Overlay</b> Confidential Copy Draft Urgent Custom Off*	Specify the overlay text printed on each page of the copy job.
<b>Custom overlay</b>	Type a custom overlay text.
<b>Note:</b> An asterisk (*) next to a value indicates the factory default setting.	

### Advanced Imaging

Menu item	Description
<b>Color Dropout</b> None* Red Green Blue  <b>Default Red Threshold</b> 0–255 (128*)  <b>Default Green Threshold</b> 0–255 (128*)  <b>Default Blue Threshold</b> 0–255 (128*)	Specify which color to drop during scanning, and adjust the dropout setting for that color.
<b>Contrast</b> Best for Content* 0 1 2 3 4 5	Specify the contrast of the output.
<b>Note:</b> An asterisk (*) next to a value indicates the factory default setting.	

Menu item	Description
<b>Background Removal</b> Background Detection Level	Adjust the amount of background visible on a scanned image.
<b>Auto Center</b> Off* On	Align the content at the center of the page.
<b>Mirror Image</b> Off* On	Create a mirror image of the original document.
<b>Negative Image</b> Off* On	Create a negative image of the original document.
<b>Shadow Detail</b> -4 to 4 (0*)	Adjust the amount of shadow detail visible on a scanned image.
<b>Scan Edge to Edge</b> Off* On	Allow edge-to-edge scanning of the original document.
<b>Sharpness</b> 1–5 (3*)	Adjust the sharpness of a scanned image.
<b>Note:</b> An asterisk (*) next to a value indicates the factory default setting.	

### Admin Controls

Menu item	Description
<b>Transparency Separators</b> Off On*	Insert a blank sheet between transparencies.
<b>Allow Priority Copies</b> Off On*	Interrupt a print job to copy a page or document.
<b>Custom Job Scanning</b> Off* On	Turn on scanning of custom jobs by default.
<b>Allow Save as Shortcut</b> Off On*	Save custom copy settings as shortcuts.
<b>Sample Copy</b>	Print a sample copy.
<b>Note:</b> An asterisk (*) next to a value indicates the factory default setting.	

# Fax

## Fax Mode

Menu item	Description
<b>Fax Mode</b> Analog* Fax Server Disabled	Select a fax mode.
<b>Note:</b> An asterisk (*) next to a value indicates the factory default setting.	

## Analog Fax Setup

### General Fax Settings

Menu item	Description
<b>Fax Name</b>	Identify your fax machine.
<b>Fax Number</b>	Identify your fax number.
<b>Fax ID</b> Fax Name Fax Number*	Notify fax recipients of your fax name or fax number.
<b>Enable Manual Fax</b> Off* On	Set the printer to fax manually. <b>Notes:</b> <ul style="list-style-type: none"> <li>• This menu item does not appear if Fax Transport is set to T.38 or G711.</li> <li>• This menu item requires a line splitter and a telephone handset.</li> <li>• Use a regular telephone line to answer an incoming fax job and to dial a fax number.</li> <li>• To go directly to the Manual Fax function, touch <b>#</b> and <b>0</b> on the keypad.</li> </ul>
<b>Memory Use</b> All receive Mostly receive Equal* Mostly send All send	Set the amount of internal printer memory allocated for faxing. <b>Note:</b> This menu item prevents memory buffer conditions and failed faxes.
<b>Cancel Faxes</b> Allow* Don't Allow	Cancel outgoing faxes before they are transmitted, or cancel incoming faxes before they finish printing.
<b>Note:</b> An asterisk (*) next to a value indicates the factory default setting.	

Menu item	Description
<b>Caller ID</b> Off On* Alternate	Show the telephone number of the person sending the fax.
<b>Fax Number Masking</b> Off* From Left From Right	Specify the format for masking an outgoing fax number.
<b>Digits to Mask</b> 0–58 (0*)	Specify the number of digits to mask in an outgoing fax number.
<b>Enable Line Connected Detection</b> Off On*	Determine whether a telephone line is connected to the printer. <b>Notes:</b> <ul style="list-style-type: none"> <li>Detection takes place when turning on the printer and before each call.</li> <li>This menu item does not appear if Fax Transport is set to T.38.</li> </ul>
<b>Enable Line In Wrong Jack Detection</b> Off* On	Determine whether a telephone line is connected to the correct port on the printer. <b>Notes:</b> <ul style="list-style-type: none"> <li>Detection takes place when turning on the printer and before each call.</li> <li>This menu item does not appear if Fax Transport is set to T.38.</li> </ul>
<b>Enable Extension in Use Support</b> Off On*	Determine whether a telephone line is used by another device such as another phone on the same line. <b>Notes:</b> <ul style="list-style-type: none"> <li>This menu item is monitored continuously after turning on the printer.</li> <li>This menu item does not appear if Fax Transport is set to T.38.</li> </ul>
<b>Optimize Fax Compatibility</b>	Configure the printer fax functionality for optimal compatibility with other fax machines.
<b>Note:</b> An asterisk (*) next to a value indicates the factory default setting.	

## Fax Send Settings

Menu item	Description
<b>Resolution</b> Standard* Fine Super Fine Ultra Fine	Set the resolution of the scanned image. <b>Note:</b> A higher resolution increases fax transmission time and requires higher memory.
<b>Original Size</b> [List of paper sizes]	Specify the size of the original document. <b>Note:</b> Mixed Sizes is the U.S. factory default setting. A4 is the international factory default setting.
<b>Note:</b> An asterisk (*) next to a value indicates the factory default setting.	

Menu item	Description
<b>Orientation</b> Portrait* Landscape	Specify the orientation of the original document.
<b>Sides</b> Off* Long Edge Short Edge	Specify the page orientation of text and graphics when scanning a two-sided document.
<b>Content Type</b> Text* Text/Photo Photo Graphics	Improve the output result based on the content of the original document.
<b>Content Source</b> Black and White Laser* Color Laser Inkjet Photo/Film Magazine Newspaper Press Other	Improve the output result based on the source of the original document.
<b>Darkness</b> -4 to 4 (0*)	Adjust the darkness of the scanned image.
<b>Behind a PABX</b> Off* On	Set the printer to dial a fax number without waiting to recognize the dial tone. <b>Note:</b> Private Automated Branch Exchange (PABX) is a telephone network that allows a single access number to offer multiple lines to outside callers.
<b>Dial Mode</b> Tone* Pulse	Specify the dial mode for incoming or outgoing faxes.
<b>Note:</b> An asterisk (*) next to a value indicates the factory default setting.	

**Advanced Imaging**

Menu item	Description
<b>Color Balance</b> -4 to 4 (0*)	Adjust the amount of toner used for each color.
<b>Note:</b> An asterisk (*) next to a value indicates the factory default setting.	

Menu item	Description
<b>Color Dropout</b> None* Red Green Blue  <b>Default Red Threshold</b> 0–255 (128*)  <b>Default Green Threshold</b> 0–255 (128*)  <b>Default Blue Threshold</b> 0–255 (128*)	Specify which color to drop during scanning, and adjust the dropout setting for that color.
<b>Contrast</b> Best for Content* 0 1 2 3 4 5	Set the contrast of the output.
<b>Background Removal</b> Background Detection Content-based* Fixed Level -4 to 4 (0*)	Adjust the amount of background visible on a scanned image.  <b>Note:</b> If you want to remove the background color from the original document, then set Background Detection to Content-based. If you want to remove image noise from a photo, then set Background Detection to Fixed.
<b>Mirror Image</b> Off* On	Create a mirror image of the original document.
<b>Negative Image</b> Off* On	Create a negative image of the original document.
<b>Shadow Detail</b> -4 to 4 (0*)	Adjust the amount of shadow detail visible on a scanned image.
<b>Scan Edge to Edge</b> Off* On	Allow edge-to-edge scanning of the original document.
<b>Sharpness</b> 1–5 (3*)	Adjust the sharpness of the scanned image.
<b>Temperature</b> -4 to 4 (0*)	Specify whether to generate a cooler or warmer output.
<b>Note:</b> An asterisk (*) next to a value indicates the factory default setting.	

**Admin Controls**

Menu item	Description
<b>Automatic Redial</b> 0–9 (5*)	Adjust the number of redial attempts based on the activity levels of recipient fax machines.
<b>Redial Frequency</b> 1–200 minutes (3*)	Increase the time between redial attempts to increase the chance of sending fax successfully.
<b>Enable ECM</b> Off On*	Activate Error Correction Mode (ECM) for fax jobs. <b>Note:</b> ECM detects and corrects errors in the fax transmission process that are caused by telephone line noise and poor signal strength.
<b>Enable Fax Scans</b> Off On*	Fax documents that are scanned at the printer.
<b>Driver to Fax</b> Off On*	Allow the print driver to send fax.
<b>Allow Save as Shortcut</b> Off On*	Save fax numbers as shortcuts in the printer.
<b>Max Speed</b> 33600* 14400 9600 4800 2400	Set the maximum speed for sending fax.
<b>Custom Job Scanning</b> Off* On	Turn on scanning of custom jobs by default. <b>Note:</b> This menu item appears only when a hard disk is installed.
<b>Scan Preview</b> Off* On	Show a preview of the scan on the display. <b>Note:</b> This menu item appears only when a hard disk is installed.
<b>Enable Color Fax Scans</b> Off by default* On by default Never use Always use	Enable color scans for fax.
<b>Auto Convert Color Faxes to Mono Faxes</b> Off On*	Convert all outgoing color faxes to black and white.
<b>Note:</b> An asterisk (*) next to a value indicates the factory default setting.	



Menu item	Description
<b>Confirm Fax Number</b> Off* On	Ask the user to confirm the fax number.
<b>Dial Prefix</b>	Set a dialing prefix.
<b>Dialing Prefix Rules</b> Prefix Rule [x]	Establish a dialing prefix rule.
<b>Note:</b> An asterisk (*) next to a value indicates the factory default setting.	

## Fax Receive Settings

Menu item	Description
<b>Fax Job Waiting</b> None* Toner Toner and Supplies	Remove fax jobs that request specific unavailable resources from the print queue.
<b>Rings to Answer</b> 1–25 (3*)	Set the number of rings for incoming fax.
<b>Auto Reduction</b> On* Off	Scale incoming fax to fit on the page.
<b>Paper Source</b> Tray [x] MP Feeder Auto*	Set the paper source for printing incoming fax.
<b>Sides</b> On Off*	Print on both sides of the paper.
<b>Separator Sheets</b> Off* Before Job After Job	Specify whether to insert blank separator sheets when printing.
<b>Separator Sheet Source</b> Tray [x] (1*) MP Feeder	Specify the paper source for the separator sheet.
<b>Output Bin</b> Standard Bin* Bin [x]	Specify the output bin for received faxes.
<b>Fax Footer</b> On Off*	Print the transmission information at the bottom of each page from a received fax.
<b>Note:</b> An asterisk (*) next to a value indicates the factory default setting.	

Menu item	Description
<b>Fax Footer Time Stamp</b> Receive* Print	Print the time stamp at the bottom of each page from a received fax.
<b>Holding Faxes</b> Held Fax Mode Off* Always On Manual Scheduled	Hold received faxes from printing until they are released.
<b>Note:</b> An asterisk (*) next to a value indicates the factory default setting.	

**Admin Controls**

Menu item	Description
<b>Enable Fax Receive</b> On* Off	Set the printer to receive fax.
<b>Enable Caller ID</b> Off On*	Show the number that is sending the incoming fax.
<b>Block No Name Fax</b> On Off*	Block incoming faxes sent from devices with no station ID or fax ID specified.
<b>Banned Fax List</b> Add Banned Fax	Specify the phone numbers that you want to block.
<b>Answer On</b> All Rings* Single Ring Only Double Ring Only Triple Ring Only Single or Double Rings Only Single or Triple Rings Only Double or Triple Rings Only	Set a distinctive ring pattern for incoming fax.
<b>Auto Answer</b> On* Off	Set the printer to receive fax automatically.
<b>Note:</b> An asterisk (*) next to a value indicates the factory default setting.	

Menu item	Description
<b>Manual Answer Code</b> 0–9 (9*)	Manually enter a code on the telephone number pad to begin receiving fax.  <b>Notes:</b> <ul style="list-style-type: none"> <li>• This menu item appears only when the printer shares a line with a telephone.</li> <li>• This menu item appears only when you set the printer to receive fax manually.</li> </ul>
<b>Fax Forwarding</b> Print Print and Forward Forward*	Specify how to forward received fax.
<b>Forward to</b> Destination [x] Type Shortcut Number	Specify where to forward received fax.
<b>Confirmation E-mail</b>	Send a confirmation e-mail when fax forwarding is successful.  <b>Note:</b> The e-mail is sent only when forwarding to FTP or Network Share destinations.
<b>Max Speed</b> 33600* 14400 9600 4800 2400	Set the maximum speed for transmitting fax.
<b>Note:</b> An asterisk (*) next to a value indicates the factory default setting.	

## Fax Cover Page

Menu item	Description
<b>Fax Cover Page</b> Off by Default* On by Default Never Use Always Use	Configure the settings for the fax cover page.
<b>Include To field</b> Off* On	
<b>Include From field</b> Off* On	
<b>From</b>	
<b>Include Message Field</b> Off* On	
<b>Message:</b>	
<b>Include Logo</b> Off* On	
<b>Include Footer [x]</b> Off* On	
<b>Footer [x]</b>	
<b>Note:</b> An asterisk (*) next to a value indicates the factory default setting.	

## Fax Log Settings

Menu item	Description
<b>Transmission Log</b> Print log* Do Not Print Log Print Only For Error	Print a log for successful fax transmission or transmission error.
<b>Receive Error Log</b> Print Never* Print on Error	
<b>Auto Print Logs</b> On* Off	
<b>Note:</b> An asterisk (*) next to a value indicates the factory default setting.	

Menu item	Description
<b>Log Paper Source</b> Tray [x] (1*) Multipurpose Feeder	Specify the paper source for printing logs.
<b>Logs Display</b> Remote Fax Name* Dialed Number	Identify the sender by remote fax name or fax number.
<b>Enable Job Log</b> On* Off	View a summary of all fax jobs.
<b>Enable Call Log</b> On* Off	View a summary of fax dialing history.
<b>Log Output Bin</b> Standard Bin* Bin [x]	Specify the output bin for printed logs.
<b>Note:</b> An asterisk (*) next to a value indicates the factory default setting.	

## Speaker Settings

Menu item	Description
<b>Speaker Mode</b> Always Off Always On On until Connected*	Set the fax speaker mode.
<b>Speaker Volume</b> Low* High	Adjust the fax speaker volume.
<b>Ringer Volume</b> Off On*	Enable the ringer volume.
<b>Note:</b> An asterisk (*) next to a value indicates the factory default setting.	

## Fax Server Setup

### General Fax Settings

Menu item	Description
<b>To Format</b>	Specify a fax recipient.  <b>Note:</b> If you want to use the fax number, then type the number sign (#) before a number.
<b>Note:</b> An asterisk (*) next to a value indicates the factory default setting.	

Menu item	Description
<b>Reply Address</b>	Specify a reply address for sending fax.
<b>Subject</b>	Specify the fax subject and message.
<b>Message</b>	
<b>Enable analog receive</b> Off* On	Set the printer to receive analog faxes.
<b>Note:</b> An asterisk (*) next to a value indicates the factory default setting.	

### Fax Server E-mail Settings

Menu item	Description
<b>Primary SMTP Gateway</b>	Type the IP address or host name of the primary Simple Mail Transfer Protocol (SMTP) server for sending e-mail.
<b>Primary SMTP Gateway Port</b> 1–65535 (25*)	Enter the port number of the primary SMTP server.
<b>Secondary SMTP Gateway</b>	Type the server IP address or host name of your secondary or backup SMTP server.
<b>Secondary SMTP Gateway Port</b> 1–65535 (25*)	Enter the server port number of your secondary or backup SMTP server.
<b>SMTP Timeout</b> 5–30 (30*)	Set the time before the printer times out if the SMTP server does not respond.
<b>Reply Address</b>	Specify a reply address for sending fax.
<b>Always use SMTP default Reply Address</b> Off On*	Specify the SMTP reply address for sending fax.
<b>Use SSL/TLS</b> Disabled* Negotiate Required	Specify whether to send fax using an encrypted link.
<b>Require Trusted Certificate</b> Off On*	Specify a trusted certificate when accessing the SMTP server.
<b>SMTP Server Authentication</b> No authentication required* Login / Plain NTLM CRAM-MD5 Digest-MD5 Kerberos 5	Set the authentication type for the SMTP server.
<b>Note:</b> An asterisk (*) next to a value indicates the factory default setting.	

Menu item	Description
<b>Device-Initiated E-mail</b> None* Use Device SMTP Credentials	Specify whether credentials are required for device-initiated e-mail.
<b>User-Initiated E-mail</b> None* Use Device SMTP Credentials Use Session User ID and Password Use Session E-mail address and Password Prompt user	Specify whether credentials are required for user-initiated e-mail.
<b>Use Active Directory Device Credentials</b> Off On*	Enable user credentials and group destinations to connect to the SMTP server.
<b>Device Userid</b>	Specify the user ID and password to connect to the SMTP server.
<b>Device Password</b>	
<b>Kerberos 5 REALM</b>	Specify the realm for the Kerberos 5 authentication protocol.
<b>NTLM Domain</b>	Specify the domain name for the NTLM security protocol.
<b>Disable "SMTP server not set up" error</b> Off* On	Hide the "SMTP server not set up" error message.
<b>Note:</b> An asterisk (*) next to a value indicates the factory default setting.	

### Fax Server Scan Settings

Menu item	Description
<b>Image Format</b> TIFF (.tif) PDF (.pdf)* XPS (.xps) TXT (.txt) RTF (.rtf) DOCX (.docx)	Specify the file format for the scanned image.
<b>Content Type</b> Text Text/Photo* Photo Graphics	Improve the output result based on the content of the original document.
<b>Note:</b> An asterisk (*) next to a value indicates the factory default setting.	

Menu item	Description
<b>Content Source</b> Black and White Laser Color Laser* Inkjet Photo/Film Magazine Newspaper Press Other	Improve the output result based on the source of the original document.
<b>Fax Resolution</b> Standard* Fine Super Fine Ultra Fine	Set the fax resolution.
<b>Darkness</b> 1–9 (5*)	Set the darkness of the output.
<b>Orientation</b> Portrait* Landscape	Specify the orientation of text and graphics on the page.
<b>Original Size</b> [List of paper sizes]	Set the paper size of the original document.  <b>Notes:</b> <ul style="list-style-type: none"> <li>• Mixed Sizes is the U.S. factory default setting. A4 is the international factory default setting.</li> <li>• This setting may vary depending on your printer model.</li> </ul>
<b>Use Multi-Page TIFF</b> Off On*	Choose between single- and multiple-page TIFF files.
<b>Note:</b> An asterisk (*) next to a value indicates the factory default setting.	

## E-mail

### E-mail Setup

Menu item	Description
<b>Primary SMTP Gateway</b>	Type the IP address or host name of the primary SMTP server for sending e-mail.
<b>Primary SMTP Gateway Port</b> 1–65535 (25*)	Enter the port number of the primary SMTP server.
<b>Note:</b> An asterisk (*) next to a value indicates the factory default setting.	



Menu item	Description
<b>Secondary SMTP Gateway</b>	Type the server IP address or host name of your secondary or backup SMTP server.
<b>Secondary SMTP Gateway Port</b> 1–65535 (25*)	Enter the server port number of your secondary or backup SMTP server.
<b>SMTP Timeout</b> 5–30 seconds (30*)	Set the time before the printer times out if the SMTP server does not respond.
<b>Reply Address</b>	Specify a reply address in the e-mail.
<b>Always use SMTP default Reply Address</b> On* Off	Always use the default reply address in the SMTP server.
<b>Use SSL/TLS</b> Disabled* Negotiate Required	Specify whether to send e-mail using an encrypted link.
<b>Require Trusted Certificate</b> Off On*	Require a trusted certificate when accessing the SMTP server.
<b>SMTP Server Authentication</b> No authentication required* Login / Plain NTLM CRAM-MD5 Digest-MD5 Kerberos 5	Set the authentication type for the SMTP server.
<b>Device-Initiated E-mail</b> None* Use Device SMTP Credentials	Specify whether credentials are required for device-initiated e-mail.
<b>User-Initiated E-mail</b> None* Use Device SMTP Credentials Use Session User ID and Password Use Session E-mail address and Password Prompt user	Specify whether credentials are required for user-initiated e-mail.
<b>Use Active Directory Device Credentials</b> Off On*	Enable user credentials and group designations to connect to the SMTP server.

**Note:** An asterisk (\*) next to a value indicates the factory default setting.

Menu item	Description
<b>Device Userid</b>	Specify the user ID and password to connect to the SMTP server.
<b>Device Password</b>	
<b>Kerberos 5 REALM</b>	Specify the realm for the Kerberos 5 authentication protocol.
<b>NTLM Domain</b>	Specify the domain name for the NTLM security protocol.
<b>Disable "SMTP server not set up" error</b> Off* On	Hide the "SMTP server not set up" error message.
<b>Note:</b> An asterisk (*) next to a value indicates the factory default setting.	

## E-mail Defaults

Menu item	Description
<b>Subject</b>	Specify the e-mail subject and message.
<b>Message</b>	
<b>File Name</b>	Specify the file name for the scanned image.
<b>Format</b> PDF (.pdf)* TIFF (.tif) JPEG (.jpg) XPS (.xps) TXT (.txt) RTF (.rtf) DOCX (.docx)	Specify the file format for the scanned image.
<b>Global OCR Settings</b> Recognized Languages Auto Rotate Despeckle Auto Contrast Enhance	Configure the settings for optical character recognition (OCR). <b>Note:</b> This menu item appears only if you have purchased and installed an OCR solution.
<b>Note:</b> An asterisk (*) next to a value indicates the factory default setting.	

Menu item	Description
<b>PDF Settings</b> PDF Version 1.3 1.4 1.5* 1.6 1.7 Archival Version A-1a* A-1b Highly Compressed Off* On Secure Off* On Searchable Off* On Archival (PDF/A) Off* On	Set the PDF format of the scanned image.
<b>Content Type</b> Text Text/Photo* Photo Graphics	Improve the output result based on the content of the original document.
<b>Content Source</b> Black and White Laser* Color Laser Inkjet Photo/Film Magazine Newspaper Press Other	Improve the output result based on the original document.
<b>Color</b> Black and White Gray Color* Auto	Specify the color when scanning an image.
<b>Note:</b> An asterisk (*) next to a value indicates the factory default setting.	

Menu item	Description
<b>Resolution</b> 75 dpi 150 dpi* 200 dpi 300 dpi 400 dpi 600 dpi	Set the resolution of the scanned image.
<b>Darkness</b> -4 to 4 (0*)	Adjust the darkness of the scanned image.
<b>Orientation</b> Portrait* Landscape	Specify the orientation of text and graphics on the page.
<b>Original Size</b> [List of paper sizes]	Set the paper size of the original document. <b>Note:</b> Mixed Sizes is the factory default setting.
<b>Sides</b> Off* Long Edge Short Edge	Specify the page orientation of text and graphics when scanning a two-sided document.
<b>Note:</b> An asterisk (*) next to a value indicates the factory default setting.	

### Advanced Imaging

Menu item	Description
<b>Color Balance</b> Cyan to Red -4 to 4 (0*) Magenta to Green -4 to 4 (0*) Yellow to Blue -4 to 4 (0*)	Adjust the color intensity during scanning.
<b>Color Dropout</b> Color Dropout None* Red Green Blue Default Red Threshold 0–255 (128*) Default Green Threshold 0–255 (128*) Default Blue Threshold 0–255 (128*)	Specify which color to drop during scanning, and adjust the dropout setting for that color.
<b>Note:</b> An asterisk (*) next to a value indicates the factory default setting.	

Menu item	Description
<b>Auto Color Detect</b> Color Sensitivity 1–9 (5*) Area Sensitivity 1–9 (5*) E-mail Bit Depth 1 bit* 8 bit	Set the amount of color that the printer detects from the original document. <b>Note:</b> This menu item appears only when Color is set to Auto.
<b>JPEG Quality</b> Best for content* 5–95	Set the quality of a JPEG-format scanned image. <b>Notes:</b> <ul style="list-style-type: none"> <li>• 5 reduces the file size, but lessens the image quality.</li> <li>• 95 provides the best image quality, but produces a large file size.</li> </ul>
<b>Contrast</b> Best for content* 0 1 2 3 4 5	Specify the contrast of the output.
<b>Background Removal</b> Background Detection Content-based* Fixed Level -4 to 4 (0*)	Adjust the amount of background visible on a scanned image. <b>Note:</b> If you want to remove the background color from the original document, then set Background Detection to Content-based. If you want to remove image noise from a photo, then set Background Detection to Fixed.
<b>Mirror Image</b> Off* On	Create a mirror image of the original document.
<b>Negative Image</b> Off* On	Create a negative image of the original document.
<b>Shadow Detail</b> -4 to 4 (0*)	Adjust the amount of shadow detail visible on a scanned image.
<b>Scan Edge to Edge</b> Off* On	Allow edge-to-edge scanning of the original document.
<b>Sharpness</b> 1–5 (3*)	Adjust the sharpness of a scanned image.
<b>Note:</b> An asterisk (*) next to a value indicates the factory default setting.	

Menu item	Description
<b>Temperature</b> -4 to 4 (0*)	Specify whether to generate a cooler or warmer output.
<b>Blank Pages</b> Blank Page Removal Blank Page Sensitivity	Specify whether to include blank pages.
<b>Note:</b> An asterisk (*) next to a value indicates the factory default setting.	

### Admin Controls

Menu item	Description
<b>Max E-mail Size</b> 0–65535 (0*)	Set the allowable file size for each e-mail.
<b>Size Error Message</b>	Specify an error message that the printer sends when an e-mail exceeds its allowable file size. <b>Note:</b> You can type up to 1024 characters.
<b>Limit Destinations</b>	Limit sending of e-mail only to the specified list of domain names. <b>Note:</b> Use a comma to separate each domain.
<b>Send Me a Copy</b> Never appears* On by Default Off by Default Always On	Send a copy of the e-mail to yourself.
<b>Limit E-mail Recipients</b> Off* On	Limit the number of e-mail recipients.
<b>Use cc:/bcc:</b> Off* On	Enable carbon copy and blind carbon copy in e-mail.
<b>Use Multi-Page TIFF</b> On* Off	Choose between single- and multiple-page TIFF files.
<b>TIFF Compression</b> LZW* JPEG	Set a compression option for TIFF files.
<b>Text Default</b> 5–95 (75*)	Set the quality of text on a scanned image.
<b>Text/Photo Default</b> 5–95 (75*)	Set the quality of text or photo on a scanned image.
<b>Photo Default</b> 5–95 (50*)	Set the quality of a photo on a scanned image.
<b>Note:</b> An asterisk (*) next to a value indicates the factory default setting.	

Menu item	Description
<b>Transmission Log</b> Print log* Do Not Print Log Print Only For Error	Print a log for successful e-mail transmission.
<b>Log Paper Source</b> Tray [x] (1*) Multipurpose Feeder	Specify the paper source for printing logs.
<b>Custom Job Scanning</b> Off* On	Turn on scanning of custom jobs by default. <b>Note:</b> This menu item appears only when a hard disk is installed.
<b>Scan Preview</b> Off On*	Show the scan preview on the display. <b>Note:</b> This menu item appears only when a printer hard disk is installed.
<b>Allow Save as Shortcut</b> Off On*	Save e-mail addresses as shortcuts. <b>Note:</b> When set to Off, the Save As Shortcut button does not appear on the e-mail Destination screen.
<b>E-mail Images Sent As</b> Attachment* Web Link	Specify how to send the images in e-mail.
<b>Reset E-mail Information After Sending</b> Off On*	Restore the default e-mail information after sending an e-mail.
<b>Note:</b> An asterisk (*) next to a value indicates the factory default setting.	

## Web Link Setup

Menu item	Description
<b>Server</b>	Set the printer to send e-mail as a web link.
<b>Login</b>	
<b>Password</b>	
<b>Path</b>	
<b>File Name</b>	
<b>Web Link</b>	

# FTP

## FTP Defaults

Menu item	Description
<p><b>Format</b></p> <ul style="list-style-type: none"> <li>PDF (.pdf)*</li> <li>TIFF (.tif)</li> <li>JPEG (.jpg)</li> <li>XPS (.xps)</li> <li>TXT (.txt)</li> <li>RTF (.rtf)</li> <li>DOCX (.docx)</li> </ul>	<p>Specify the file format for the scanned image.</p> <p><b>Note:</b> The menu items may vary depending on your printer model.</p>
<p><b>Global OCR Settings</b></p> <ul style="list-style-type: none"> <li>Recognized Languages</li> <li>Auto Rotate</li> <li>Despeckle</li> <li>Auto Contrast Enhance</li> </ul>	<p>Configure the settings for optical character recognition (OCR).</p> <p><b>Note:</b> This menu appears only if you have purchased and installed an OCR solution.</p>
<p><b>PDF Settings</b></p> <ul style="list-style-type: none"> <li>PDF Version                             <ul style="list-style-type: none"> <li>1.3</li> <li>1.4</li> <li>1.5*</li> <li>1.6</li> <li>1.7</li> </ul> </li> <li>Archival Version                             <ul style="list-style-type: none"> <li>A-1a*</li> <li>A-1b</li> </ul> </li> <li>Highly Compressed                             <ul style="list-style-type: none"> <li>Off*</li> <li>On</li> </ul> </li> <li>Secure                             <ul style="list-style-type: none"> <li>Off*</li> <li>On</li> </ul> </li> <li>Searchable                             <ul style="list-style-type: none"> <li>Off*</li> <li>On</li> </ul> </li> <li>Archival (PDF/A)                             <ul style="list-style-type: none"> <li>Off*</li> <li>On</li> </ul> </li> </ul>	<p>Set the PDF format for the scanned image.</p>

**Note:** An asterisk (\*) next to a value indicates the factory default setting.



Menu item	Description
<b>Content Type</b> Text Text/Photo* Graphics Photo	Improve the output result based on the content of the original document.
<b>Content Source</b> Black and White Laser Color Laser* Inkjet Photo/Film Magazine Newspaper Press Other	Improve the output result based on the source of the original document.
<b>Color</b> Black and White Gray Color* Auto	Specify the color when scanning an image.
<b>Resolution</b> 75 dpi 150 dpi* 200 dpi 300 dpi 400 dpi 600 dpi	Set the resolution of the scanned image.
<b>Darkness</b> -4 to 4 (0*)	Adjust the darkness of the scanned image.
<b>Orientation</b> Portrait* Landscape	Specify the orientation of text and graphics on the page.
<b>Original Size</b> [List of paper sizes]	Set the paper size of the original document. <b>Notes:</b> <ul style="list-style-type: none"> <li>• Letter is the U.S. factory default setting. A4 is the international factory default setting.</li> <li>• The menu items may vary depending on your printer model.</li> </ul>
<b>Sides</b> Off* Long Edge Short Edge	Specify the page orientation of text and graphics when scanning a two-sided document.
<b>File Name</b>	Specify the file name of the scanned image.
<b>Note:</b> An asterisk (*) next to a value indicates the factory default setting.	

**Advanced Imaging**

Menu item	Description
<b>Color Balance</b> Cyan to Red -4 to 4 (0*) Magenta to Green -4 to 4 (0*) Yellow to Blue -4 to 4 (0*)	Adjust the color intensity during scanning.
<b>Color Dropout</b> Color Dropout None* Red Green Blue Default Red Threshold 0–255 (128*) Default Green Threshold 0–255 (128*) Default Blue Threshold 0–255 (128*)	Specify which color to drop during scanning, and adjust the dropout setting for that color.
<b>Auto Color Detect</b> Color Sensitivity 1–9 (5*) Area Sensitivity 1–9 (5*) FTP Bit Depth 1 bit* 8 bit	Set the amount of color that the printer detects from the original document. <b>Note:</b> This menu item appears only when Color is set to Auto.
<b>JPEG Quality</b> Best for content* 5–95	Set the quality of a JPEG-format image. <b>Notes:</b> <ul style="list-style-type: none"> <li>• 5 reduces the file size, but lessens the image quality.</li> <li>• 90 provides the best image quality, but produces a large file size.</li> </ul>
<b>Contrast</b> Best for content* 0 1 2 3 4 5	Specify the contrast of the output.
<b>Note:</b> An asterisk (*) next to a value indicates the factory default setting.	

Menu item	Description
<b>Background Removal</b> Background Detection Content-based* Fixed Level -4 to 4 (0*)	Adjust the amount of background visible on a scanned image.  <b>Note:</b> If you want to remove the background color from the original document, then set Background Detection to Content-based. If you want to remove image noise from a photo, then set Background Detection to Fixed.
<b>Mirror Image</b> Off* On	Create a mirror image of the original document.
<b>Negative Image</b> Off* On	Create a negative image of the original document.
<b>Shadow Detail</b> -4 to 4 (0*)	Adjust the amount of shadow detail visible on a scanned image.
<b>Scan Edge to Edge</b> Off* On	Allow edge-to-edge scanning of the original document.
<b>Sharpness</b> 1–5 (3*)	Adjust the sharpness of a scanned image.
<b>Temperature</b> -4 to 4 (0*)	Specify whether to generate a cooler or warmer output.
<b>Blank Pages</b> Blank Page Removal Blank Page Sensitivity	Specify whether to include blank pages.
<b>Note:</b> An asterisk (*) next to a value indicates the factory default setting.	

### Admin Controls

Menu item	Description
<b>Text Default</b> 5–95 (75*)	Set the quality of text on a scanned image.
<b>Text/Photo Default</b> 5–95 (75*)	Set the quality of text or photo image on a scanned image.
<b>Photo Default</b> 5–95 (50*)	Set the quality of a photo image on a scanned image.
<b>Use Multi-Page TIFF</b> On* Off	Choose between single- and multiple-page TIFF files.
<b>Note:</b> An asterisk (*) next to a value indicates the factory default setting.	

Menu item	Description
<b>TIFF Compression</b> LZW* JPEG	Set a compression option for TIFF files.
<b>Transmission Log</b> Print Log* Do Not Print Log Print Only For Error	Print a log for successful FTP scan transmission.
<b>Log Paper Source</b> Tray [x] (1*) Multipurpose Feeder	Specify the paper source for printing FTP logs.
<b>Custom Job Scanning</b> Off* On	Turn on scanning of custom jobs by default. <b>Note:</b> This menu item appears only when a hard disk is installed.
<b>Scan Preview</b> Off On*	Show a preview of the scan on the display. <b>Note:</b> This menu item appears only when a hard disk is installed.
<b>Allow Save as Shortcut</b> Off On*	Save custom FTP settings as shortcuts.
<b>Note:</b> An asterisk (*) next to a value indicates the factory default setting.	

## USB Drive

### Flash Drive Scan

Menu item	Description
<b>Format</b> PDF (.pdf)* TIFF (.tif) JPEG (.jpg) XPS (.xps) TXT (.txt) RTF (.rtf) DOCX (.docx)	Specify the file format for the scanned image. <b>Note:</b> The settings may vary depending on your printer model.
<b>Global OCR Settings</b> Recognized Languages Auto Rotate Despeckle Auto Contrast Enhance	Configure the settings for optical character recognition (OCR). <b>Note:</b> This menu appears only if you have purchased and installed an OCR solution.
<b>Note:</b> An asterisk (*) next to a value indicates the factory default setting.	

Menu item	Description
<p><b>PDF Settings</b></p> <ul style="list-style-type: none"> <li>PDF Version                             <ul style="list-style-type: none"> <li>1.3</li> <li>1.4</li> <li>1.5*</li> <li>1.6</li> <li>1.7</li> </ul> </li> <li>Archival Version                             <ul style="list-style-type: none"> <li>A-1a*</li> <li>A-1b</li> </ul> </li> <li>Highly Compressed                             <ul style="list-style-type: none"> <li>Off*</li> <li>On</li> </ul> </li> <li>Secure                             <ul style="list-style-type: none"> <li>Off*</li> <li>On</li> </ul> </li> <li>Searchable                             <ul style="list-style-type: none"> <li>Off*</li> <li>On</li> </ul> </li> <li>Archival (PDF/A)                             <ul style="list-style-type: none"> <li>Off*</li> <li>On</li> </ul> </li> </ul>	<p>Set the PDF format for the scanned image.</p>
<p><b>Content Type</b></p> <ul style="list-style-type: none"> <li>Text</li> <li>Text/Photo*</li> <li>Graphics</li> <li>Photo</li> </ul>	<p>Improve the output result based on the content of the original document.</p>
<p><b>Content Source</b></p> <ul style="list-style-type: none"> <li>Black and White Laser</li> <li>Color Laser*</li> <li>Inkjet</li> <li>Photo/Film</li> <li>Magazine</li> <li>Newspaper</li> <li>Press</li> <li>Other</li> </ul>	<p>Improve the output result based on the source of the original document.</p>
<p><b>Color</b></p> <ul style="list-style-type: none"> <li>Black and White</li> <li>Gray</li> <li>Color*</li> <li>Auto</li> </ul>	<p>Specify the color when scanning an image.</p>

**Note:** An asterisk (\*) next to a value indicates the factory default setting.

Menu item	Description
<b>Resolution</b> 75 dpi 150 dpi* 200 dpi 300 dpi 400 dpi 600 dpi	Set the resolution of the scanned image.
<b>Darkness</b> 1–9 (5*)	Adjust the darkness of the scanned image.
<b>Orientation</b> Portrait* Landscape	Specify the orientation of text and graphics on the page.
<b>Original Size</b> [List of paper sizes]	Set the paper size of the original document. <b>Notes:</b> <ul style="list-style-type: none"> <li>• Letter is the U.S. factory default setting. A4 is the international factory default setting.</li> <li>• This menu item may vary depending on your printer model.</li> </ul>
<b>Sides</b> Off* Long edge Short edge	Specify the page orientation of text and graphics when scanning a two-sided document.
<b>File Name</b>	Specify the file name of the scanned image.
<b>Note:</b> An asterisk (*) next to a value indicates the factory default setting.	

### Advanced Imaging

Menu item	Description
<b>Color Balance</b> Cyan to Red -4 to 4 (0*) Magenta to Green -4 to 4 (0*) Yellow to Blue -4 to 4 (0*)	Adjust the color intensity during scanning.
<b>Note:</b> An asterisk (*) next to a value indicates the factory default setting.	

Menu item	Description
<b>Color Dropout</b> Color Dropout None* Red Green Blue Default Red Threshold 0–255 (128*) Default Green Threshold 0–255 (128*) Default Blue Threshold 0–255 (128*)	Specify which color to drop during scanning, and adjust the dropout setting for that color.
<b>Auto Color Detect</b> Color Sensitivity 1–9 (5*) Area Sensitivity 1–9 (5*) E-mail Bit Depth 1 bit* 8 bit	Set the amount of color that the printer detects from the original document. <b>Note:</b> This menu item appears only when Color is set to Auto.
<b>JPEG Quality</b> Best for content* 5–95	Set the quality of a JPEG-format image. <b>Notes:</b> <ul style="list-style-type: none"> <li>• 5 reduces the file size, but lessens the image quality.</li> <li>• 90 provides the best image quality, but produces a large file size.</li> </ul>
<b>Contrast</b> Best for content* 0 1 2 3 4 5	Specify the contrast of the output.
<b>Background Removal</b> Background Detection Content-based* Fixed Level -4 to 4 (0*)	Adjust the amount of background visible on a scanned image. <b>Note:</b> If you want to remove the background color from the original document, then set Background Detection to Content-based. If you want to remove image noise from a photo, then set Background Detection to Fixed.
<b>Mirror Image</b> Off* On	Create a mirror image of the original document.
<b>Note:</b> An asterisk (*) next to a value indicates the factory default setting.	

Menu item	Description
<b>Negative Image</b> Off* On	Create a negative image of the original document.
<b>Shadow Detail</b> -4 to 4 (0*)	Adjust the amount of shadow detail visible on a scanned image.
<b>Scan Edge to Edge</b> Off* On	Allow edge-to-edge scanning of the original document.
<b>Sharpness</b> 1–5 (3*)	Adjust the sharpness of a scanned image.
<b>Temperature</b> -4 to 4 (0*)	Specify whether to generate a cooler or warmer output.
<b>Blank Pages</b> Blank Page Removal Blank Page Sensitivity	Specify whether to include blank pages.
<b>Note:</b> An asterisk (*) next to a value indicates the factory default setting.	

### Admin Controls

Menu item	Description
<b>Text Default</b> 5–95 (75*)	Set the quality of text on a scanned image.
<b>Text/Photo Default</b> 5–95 (75*)	Set the quality of text or photo on a scanned image.
<b>Photo Default</b> 5–95 (75*)	Set the quality of a photo on a scanned image.
<b>Use Multi-Page TIFF</b> On* Off	Choose between single- and multiple-page TIFF files.
<b>TIFF Compression</b> LZW* JPEG	Set the compression for TIFF files.
<b>Custom Job Scanning</b> Off* On	Turn on scanning of custom jobs by default. <b>Note:</b> This menu item appears only when a hard disk is installed.
<b>Scan Preview</b> Off On*	Show a preview of the scan on the display. <b>Note:</b> This menu item appears only when a hard disk is installed.
<b>Note:</b> An asterisk (*) next to a value indicates the factory default setting.	



## Flash Drive Print

Menu item	Description
<b>Number of Copies</b> 1–9999 (1*)	Set the number of copies.
<b>Paper Source</b> Tray [x] (1*) Multipurpose Feeder Manual Paper Manual Envelope	Specify the paper source for the print job.
<b>Collate</b> Off [1,1,1,2,2,2] On [1,2,1,2,1,2]*	Print multiple copies in a sequence.
<b>Sides</b> 1-Sided* 2-Sided	Specify whether to print on one side or two sides of the paper.
<b>Flip Style</b> Long Edge* Short Edge	Determine which side of the paper (long edge or short edge) is bound when performing two-sided printing.  <b>Note:</b> Depending on the option selected, the printer automatically offsets each printed information of the page to bind the job correctly.
<b>Pages per Side</b> Off* 2-Up 3-Up 4-Up 6-Up 9-Up 12-Up 16-Up	Print multiple page images on a sheet of paper.
<b>Pages per Side Ordering</b> Horizontal* Reverse Horizontal Reverse Vertical Vertical	Specify the positioning of multiple page images when using Pages per Side.  <b>Note:</b> The positioning depends on the number of page images and their page orientation.
<b>Pages per Side Orientation</b> Auto* Landscape Portrait	Specify the orientation of a multiple-page document when using Pages per Side.
<b>Pages per Side Border</b> None* Solid	Print a border around each page image when using Pages per Side.
<b>Note:</b> An asterisk (*) next to a value indicates the factory default setting.	

Menu item	Description
<b>Separator Sheets</b> Off* Between Copies Between Jobs Between Pages	Specify whether to insert blank separator sheets when printing.
<b>Separator Sheet Source</b> Tray [x] (1*) Multipurpose Feeder	Specify the paper source for the separator sheet.  <b>Note:</b> For Multipurpose Feeder to appear, set Configure MP to Cassette from the Paper menu.
<b>Blank Pages</b> Do Not Print* Print	Specify whether to include blank pages in a print job.
<b>Note:</b> An asterisk (*) next to a value indicates the factory default setting.	

## Network/Ports

### Network Overview

Menu item	Description
<b>Active Adapter</b> Auto* Standard Network	Specify how a network is connected.
<b>Network Status</b>	Show the connection status of the printer network.
<b>Display Network Status on Printer</b> On* Off	Show the network status on the display.
<b>Speed, Duplex</b>	Show the speed of the currently active network card.
<b>IPv4</b>	Show the IPv4 address.
<b>All IPv6 Addresses</b>	Show all IPv6 addresses.
<b>Reset Print Server</b>	Reset all active network connections to the printer.  <b>Note:</b> This setting removes all network configuration settings.
<b>Network Job Timeout</b> Off On* (90 seconds)	Set the time before the printer cancels a network print job.
<b>Banner Page</b> Off* On	Print a banner page.
<b>Note:</b> An asterisk (*) next to a value indicates the factory default setting.	

Menu item	Description
<b>Scan to PC Port Range</b> 9751:12000*	Specify a valid port range for printers that are behind a port blocking firewall.
<b>Note:</b> An asterisk (*) next to a value indicates the factory default setting.	

## Wireless

**Note:** This menu is available only in printers connected to a Wi-Fi network or printers that have a wireless network adapter.

Menu item	Description
<b>Setup Using Mobile App</b>	Configure the Wi-Fi connection using Lexmark Mobile Assistant.
<b>Setup On Printer Panel</b> Choose Network Add Wi-Fi Network Network Name Network Mode Infrastructure Wireless Security Mode Disabled* WEP WPA2/WPA - Personal WPA2 - Personal 802.1x - RADIUS	Configure the Wi-Fi connection using the control panel. <b>Note:</b> 802.1x - RADIUS can be configured only from the Embedded Web Server.
<b>Wi-Fi Protected Setup</b> WPS Auto Detect Off On* Start Push Button Method Start PIN Method	Establish a Wi-Fi network and enable network security. <b>Notes:</b> <ul style="list-style-type: none"> <li>WPS Auto Detect appears only when the Wireless Security Mode is set to WEP.</li> <li>Start Push-Button Method connects the printer to a Wi-Fi network when buttons on both the printer and the access point (wireless router) are pressed within a given time.</li> <li>Start PIN Method connects the printer to a Wi-Fi network when a PIN on the printer is entered into the wireless settings of the access point.</li> </ul>
<b>Network Mode</b> BSS Type Infrastructure*	Specify the network mode.
<b>Enable Wi-Fi Direct</b> On Off*	Enable Wi-Fi Direct-capable devices to connect directly to the printer.
<b>Compatibility</b> 802.11b/g/n (2.4GHz)* 802.11a/b/g/n/ac (2.4GHz/5GHz) 802.11a/n/ac (5GHz)	Specify the standard for the Wi-Fi network. <b>Note:</b> 802.11a/b/g/n/ac (2.4GHz/5GHz) and 802.11a/n/ac (5GHz) only appear when a Wi-Fi option is installed.

Menu item	Description
<b>Wireless Security Mode</b> Disabled* WEP WPA2/WPA-Personal WPA2-Personal 802.1x - RADIUS	Set the security mode for connecting the printer to Wi-Fi devices. <b>Note:</b> 802.1x - RADIUS can be configured only from the Embedded Web Server.
<b>WEP Authentication Mode</b> Auto* Open Shared	Set the type of Wireless Encryption Protocol (WEP) for the printer. <b>Note:</b> This menu item appears only when the Wireless Security Mode is set to WEP.
<b>Set WEP Key</b>	Specify a WEP password for secure Wi-Fi connection.
<b>WPA2/WPA Personal</b> AES	Enable Wi-Fi security through Wi-Fi Protected Access (WPA). <b>Note:</b> This menu item appears only when the Wireless Security Mode is set to WPA2/WPA-Personal.
<b>Set Pre-Shared Key</b>	Set the password for secure Wi-Fi connection.
<b>WPA2-Personal</b> AES	Enable Wi-Fi security through WPA2. <b>Note:</b> This menu item appears only when the Wireless Security Mode is set to WPA2-Personal.
<b>802.1x Encryption Mode</b> WPA+ WPA2*	Enable Wi-Fi security through 802.1x standard. <b>Notes:</b> <ul style="list-style-type: none"> <li>• This menu item appears only when the Wireless Security Mode is set to 802.1x - RADIUS.</li> <li>• 802.1x - RADIUS can be configured only from the Embedded Web Server.</li> </ul>
<b>IPv4</b> Enable DHCP On* Off Set Static IP Address IP Address Netmask Gateway	Enable and configure IPv4 settings in the printer.

Menu item	Description
<b>IPv6</b> Enable IPv6 On* Off Enable DHCPv6 On Off* Stateless Address Autoconfiguration On* Off DNS Server Address Manually Assigned IPv6 Address Manually Assigned IPv6 Router Address Prefix All IPv6 Addresses All IPv6 Router Addresses	Enable and configure IPv6 settings in the printer.
<b>Network Address</b> UAA LAA	View the network addresses.
<b>PCL SmartSwitch</b> Off On*	Set the printer to switch automatically to PCL emulation when a print job requires it, regardless of the default printer language.  <b>Note:</b> If PCL SmartSwitch is off, then the printer does not examine incoming data and uses the default printer language specified in the Setup menu.
<b>PS SmartSwitch</b> Off On*	Set the printer to switch automatically to PS emulation when a print job requires it, regardless of the default printer language.  <b>Note:</b> If PS SmartSwitch is off, then the printer does not examine incoming data and uses the default printer language specified in the Setup menu.
<b>Job Buffering</b> On Off*	Temporarily store print jobs in the printer hard disk before printing.  <b>Note:</b> This menu item appears only when a hard disk is installed.
<b>Mac Binary PS</b> Auto* On Off	Set the printer to process Macintosh binary PostScript print jobs.  <b>Notes:</b> <ul style="list-style-type: none"> <li>• On processes raw binary PostScript print jobs.</li> <li>• Off filters print jobs using the standard protocol.</li> </ul>

## Ethernet

Menu item	Description
<b>Network Speed</b>	Show the speed of an active network adapter.
<b>Note:</b> An asterisk (*) next to a value indicates the factory default setting.	

Menu item	Description
<b>IPv4</b> Enable DHCP On* Off	Enable Dynamic Host Configuration Protocol (DHCP).  <b>Note:</b> DHCP is a standard protocol that allows a server to dynamically distribute IP addressing and configuration information to clients.
<b>IPv4</b> Set Static IP Address IP Address Netmask Gateway	Set the static IP address of your printer.
<b>Enable IPv6</b> On* Off	Configure IPv6 in the printer.
<b>Enable DHCPv6</b> On Off*	Run DHCPv6 in an IPv6 network.
<b>Stateless Address Autoconfiguration</b> On* Off	Set the network adapter to accept the automatic IPv6 address configuration entries provided by a router.
<b>DNS Address</b>	Specify the DNS server address, IP address, and the router for IPv6 network.
<b>Manually Assigned IPv6 Address</b>	
<b>Manually Assigned IPv6 Router</b>	
<b>Address Prefix</b> 0–128 (64*)	
<b>All IPv6 Addresses</b>	Show all IP and router addresses used in an IPv6 network.
<b>All IPv6 Router Addresses</b>	
<b>Network Address</b> UAA LAA	Show the printer Media Access Control (MAC) addresses: Locally Administered Address (LAA) and Universally Administered Address (UAA).  <b>Note:</b> You can change the printer LAA manually.
<b>PCL SmartSwitch</b> On* Off	Set the printer to switch automatically to PCL emulation when a print job requires it, regardless of the default printer language.  <b>Note:</b> If PCL SmartSwitch is off, then the printer does not examine incoming data and uses the default printer language specified in the Setup menu.
<b>PS SmartSwitch</b> On* Off	Set the printer to switch automatically to PS emulation when a print job requires it, regardless of the default printer language.  <b>Note:</b> If PS SmartSwitch is off, then the printer does not examine incoming data and uses the default printer language specified in the Setup menu.
<b>Note:</b> An asterisk (*) next to a value indicates the factory default setting.	

Menu item	Description
<b>Mac Binary PS</b> Auto* On Off	Set the printer to process Macintosh binary PostScript print jobs.  <b>Notes:</b> <ul style="list-style-type: none"> <li>• On processes raw binary PostScript print jobs.</li> <li>• Off filters print jobs using the standard protocol.</li> </ul>
<b>Energy Efficient Ethernet</b> On* Off	Reduce power consumption when the printer receives no data from the Ethernet network.
<b>Note:</b> An asterisk (*) next to a value indicates the factory default setting.	

## TCP/IP

**Note:** This menu appears only in network printers or printers attached to print servers.

Menu item	Description
<b>Set Hostname</b>	Set the current TCP/IP host name.
<b>Domain Name</b>	Set the domain name.
<b>Allow DHCP/BOOTP to update NTP server</b> On* Off	Allow the DHCP and BOOTP clients to update the NTP settings of the printer.
<b>Zero Configuration Name</b>	Specify a service name for the zero configuration network.
<b>Enable Auto IP</b> On* Off	Assign an IP address automatically.
<b>DNS Address</b>	Specify the current Domain Name System (DNS) server address.
<b>Backup DNS Address</b>	Specify the backup DNS server addresses.
<b>Backup DNS Address 2</b>	
<b>Backup DNS Address 3</b>	
<b>Domain Search Order</b>	Specify a list of domain names to locate the printer and its resources that reside in different domains on the network.
<b>Enable DDNS</b> On* Off	Update Dynamic DNS settings.
<b>DDNS TTL</b>	Specify the current DDNS settings.
<b>Default TTL</b>	
<b>DDNS Refresh Time</b>	
<b>Note:</b> An asterisk (*) next to a value indicates the factory default setting.	

Menu item	Description
<b>Enable mDNS</b> Off On*	Update multicast DNS settings.
<b>WINS Address</b>	Specify a server address for Windows Internet Name Service (WINS).
<b>Enable BOOTP</b> Off* On	Allow the BOOTP to assign a printer IP address.
<b>Restricted Server List</b>	Specify an IP address for the TCP connections.  <b>Notes:</b> <ul style="list-style-type: none"> <li>• Use a comma to separate each IP address.</li> <li>• You can add up to 50 IP addresses.</li> </ul>
<b>Restricted Server List Options</b> Block All Ports* Block Printing Only Block Printing and HTTP Only	Specify how the IP addresses in the list can access the printer functionality.
<b>MTU</b>	Specify a maximum transmission unit (MTU) parameter for the TCP connections.
<b>Raw Print Port</b> 1–65535 (9100*)	Specify a raw port number for printers connected on a network.
<b>Outbound Traffic Maximum Speed</b> Off* 100 to 1000000	Enable the printer maximum transfer rate.
<b>Enhanced TLS Security</b> On Off*	Enhance printer privacy and data integrity.
<b>Note:</b> An asterisk (*) next to a value indicates the factory default setting.	

## SNMP

**Note:** This menu appears only in network printers or printers that are attached to print servers.



Menu item	Description
<p><b>SNMP Versions 1 and 2c</b></p> <ul style="list-style-type: none"> <li>Enabled</li> <li>Off</li> <li>On*</li> <li>Allow SNMP Set</li> <li>Off</li> <li>On*</li> <li>Enable PPM MIB</li> <li>Off</li> <li>On*</li> <li>SNMP Community</li> </ul>	<p>Configure Simple Network Management Protocol (SNMP) versions 1 and 2c to install print drivers and applications.</p>
<p><b>SNMP Version 3</b></p> <ul style="list-style-type: none"> <li>Enabled</li> <li>Off</li> <li>On*</li> <li>Set Read/Write Credentials                             <ul style="list-style-type: none"> <li>User Name</li> <li>Password</li> </ul> </li> <li>Set Read-only Credentials                             <ul style="list-style-type: none"> <li>User Name</li> <li>Password</li> </ul> </li> <li>Authentication Hash                             <ul style="list-style-type: none"> <li>MD5</li> <li>SHA1*</li> </ul> </li> <li>Minimum Authentication Level                             <ul style="list-style-type: none"> <li>No Authentication, No Privacy</li> <li>Authentication, No Privacy</li> <li>Authentication, Privacy*</li> </ul> </li> <li>Privacy Algorithm                             <ul style="list-style-type: none"> <li>DES</li> <li>AES-128*</li> </ul> </li> </ul>	<p>Configure SNMP version 3 to install and update printer security.</p>
<p><b>Note:</b> An asterisk (*) next to a value indicates the factory default setting.</p>	

## IPSec

**Note:** This menu appears only in network printers or printers that are attached to print servers.

Menu item	Description
<p><b>Enable IPSec</b></p> <ul style="list-style-type: none"> <li>Off*</li> <li>On</li> </ul>	<p>Enable Internet Protocol Security (IPSec).</p>
<p><b>Note:</b> An asterisk (*) next to a value indicates the factory default setting.</p>	

Menu item	Description
<b>Base Configuration</b> Default* Compatibility Secure	Set the IPSec base configuration. <b>Note:</b> This menu item appears only when Enable IPSec is set to On.
<b>DH (Diffie-Hellman) Group Proposal</b> modp2048 (14)* modp3072 (15) modp4069 (16) modp6144 (17) modp8192 (18)	Set the IPSec encryption. <b>Note:</b> This menu item appears only when Base Configuration is set to Compatibility.
<b>IKE SA Lifetime (Hours)</b> 1 2 4 8 24*	Set the amount of time before a new authentication key is generated. <b>Note:</b> These menu items appear only when Base Configuration is set to Secure.
<b>IPSec SA Lifetime (Hours)</b> 1 2 4 8 24*	
<b>Proposed Encryption Method</b> 3DES AES*	Specify the encryption and authentication methods to connect to a network securely. <b>Note:</b> These menu items appear only when Base Configuration is set to Compatibility.
<b>Proposed Authentication Method</b> SHA1 SHA256* SHA512	
<b>IPSec Device Certificate</b>	Specify an IPSec certificate. <b>Note:</b> This menu item appears only when Base Configuration is set to Compatibility.
<b>Pre-Shared Key Authenticated Connections</b> Host [x] Address Key	Configure the authenticated connections of the printer. <b>Note:</b> These menu items appear only when Enable IPSec is set to On.
<b>Certificate Authenticated Connections</b> Host [x] Address[/subnet] Address[/subnet]	
<b>Note:</b> An asterisk (*) next to a value indicates the factory default setting.	

## 802.1x

**Note:** This menu appears only in network printers or printers that are attached to print servers.

Menu item	Description
<b>Active</b> Off* On	Let the printer join networks that require authentication before allowing access.  <b>Note:</b> To configure the settings of this menu item, access the Embedded Web Server.
<b>Note:</b> An asterisk (*) next to a value indicates the factory default setting.	

## LPD Configuration

**Note:** This menu appears only in network printers or printers that are attached to print servers.

Menu item	Description
<b>LPD Timeout</b> 0–65535 seconds (90*)	Set the time-out value to stop the Line Printer Daemon (LPD) server from waiting indefinitely for hung or invalid print jobs.
<b>LPD Banner Page</b> Off* On	Print a banner page for all LPD print jobs.  <b>Note:</b> A banner page is the first page of a print job used as a separator of print jobs and to identify the originator of the print job request.
<b>LPD Trailer Page</b> Off* On	Print a trailer page for all LPD print jobs.  <b>Note:</b> A trailer page is the last page of a print job.
<b>LPD Carriage Return Conversion</b> Off* On	Enable carriage return conversion.  <b>Note:</b> Carriage return is a mechanism that commands the printer to move the position of the cursor to the first position on the same line.
<b>Note:</b> An asterisk (*) next to a value indicates the factory default setting.	

## HTTP/FTP Settings

**Note:** This menu appears only in network printers or printers attached to print servers.

Menu item	Description
<b>Enable HTTP Server</b> Off On*	Access the Embedded Web Server to monitor and manage the printer.
<b>Enable HTTPS</b> Off On*	Configure the Hypertext Transfer Protocol Secure (HTTPS) settings.
<b>Note:</b> An asterisk (*) next to a value indicates the factory default setting.	

Menu item	Description
<b>Enable FTP/TFTP</b> Off On*	Send files using FTP.
<b>Local Domains</b>	Specify domain names for HTTP and FTP servers. <b>Note:</b> This menu item appears only in some printer models.
<b>HTTP Proxy IP Address</b>	Configure the HTTP and FTP server settings. <b>Note:</b> These menu items appear only in some printer models.
<b>FTP Proxy IP Address</b>	
<b>HTTP Default IP Port</b> 1–65535 (80*)	
<b>HTTPS Device Certificate</b>	
<b>FTP Default IP Port</b> 1–65535 (21*)	
<b>Timeout for HTTP/FTP Requests</b> 1–299 (30*)	Specify the amount of time before the server connection stops.
<b>Retries for HTTP/FTP Requests</b> 1–299 (3*)	Set the number of retries to connect to the HTTP/FTP server.
<b>Note:</b> An asterisk (*) next to a value indicates the factory default setting.	

## ThinPrint

Menu item	Description
<b>Enable ThinPrint</b> Off On*	Print using ThinPrint.
<b>Port Number</b> 4000–4999 (4000*)	Set the port number for the ThinPrint server.
<b>Bandwidth (bits/sec)</b> 0* 100–1000000	Set the speed to transmit data in a ThinPrint environment.
<b>Packet Size (kbytes)</b> 0–64000 (0*)	Set the packet size for data transmission.
<b>Note:</b> An asterisk (*) next to a value indicates the factory default setting.	

## USB

Menu item	Description
<b>PCL SmartSwitch</b> Off On*	Set the printer to switch to PCL emulation when a print job received through a USB port requires it, regardless of the default printer language.  <b>Note:</b> If PCL SmartSwitch is off, then the printer does not examine incoming data and uses the default printer language specified in the Setup menu.
<b>PS SmartSwitch</b> Off On*	Set the printer to switch to PS emulation when a print job received through a USB port requires it, regardless of the default printer language.  <b>Note:</b> If PS SmartSwitch is off, then the printer does not examine incoming data and uses the default printer language specified in the Setup menu.
<b>NPA Mode</b> On Auto* Off	Set the printer to perform the special processing required for bidirectional communication, following the conventions defined by the NPA protocol.  <b>Note:</b> The printer restarts after changing the setting.
<b>Mac Binary PS</b> On Auto* Off	Set the printer to process Macintosh binary PostScript print jobs.  <b>Notes:</b> <ul style="list-style-type: none"> <li>• On processes raw binary PostScript print jobs.</li> <li>• Off filters print jobs using the standard protocol.</li> </ul>
<b>Enable USB Port</b> Off On*	Enable the standard USB port.
<b>Note:</b> An asterisk (*) next to a value indicates the factory default setting.	

## Google Cloud Print

Menu item	Description
<b>Registration</b> Register	Register the printer to the Google Cloud server.
<b>Options</b> Enable Google Cloud Print Off On*	Print directly from your Google account.
<b>Options</b> Enable Local Discovery Off On*	Allow higher bandwidth for data transmission.
<b>Options</b> Enable SSL Peer Verification Off On*	Verify authenticity of the peer certificate to connect to your Google account.
<b>Note:</b> An asterisk (*) next to a value indicates the factory default setting.	

Menu item	Description
<b>Options</b> Always Print As Image Off* On	Enable the Always Print As Image feature.
<b>Note:</b> An asterisk (*) next to a value indicates the factory default setting.	

## Wi-Fi Direct

**Note:** This menu appears only when a direct Wi-Fi network is the active network.

Menu item	Description
<b>SSID</b>	Specify the service set identifier (SSID) of the Wi-Fi network.
<b>Set Preshared Key</b>	Set the preshared key (PSK) to authenticate and validate users on a Wi-Fi connection.
<b>Show PSK on Setup Page</b> Off On*	Show the PSK on the Network Setup Page.
<b>Group Owner IP Address</b>	Specify the IP address of the group owner.
<b>Auto-Accept Push Button Requests</b> Off* On	Accept requests to connect to the network automatically. <b>Note:</b> Accepting clients automatically is not secured.
<b>Note:</b> An asterisk (*) next to a value indicates the factory default setting.	

# Security

## Login Methods

### Manage Permissions

Menu item	Description
<b>Function Access</b> Access Address Book in Apps Modify Address Book Manage Shortcuts Create Profiles Manage Bookmarks Flash Drive Print Flash Drive Scan Copy Function Color Dropout E-mail Function Fax Function FTP Function Release Held Faxes Held Jobs Access User Profiles Cancel Jobs at the Device Change Language Internet Printing Protocol (IPP) Initiate Scans Remotely B/W Print	Control access to the printer functions.
<b>Administrative Menus</b> Security Menu Network/Ports Menu Paper Menu Reports Menu Function Configuration Menus Supplies Menu Option Card Menu SE Menu Device Menu	Control access to the printer menu settings.
<b>Device Management</b> Remote Management Firmware Updates Apps Configuration Operator Panel Lock Import/Export All Settings Out of Service Erase	Control access to the printer management options.

Menu item	Description
<p><b>Apps</b></p> <ul style="list-style-type: none"> <li>New Apps</li> <li>Slideshow</li> <li>Change Wallpaper</li> <li>Screen Saver</li> <li>Card Copy</li> <li>Scan Center</li> <li>Scan Center Custom 1</li> <li>Scan Center Custom 2</li> <li>Scan Center Custom 3</li> <li>Scan Center Custom 4</li> <li>Scan Center Custom 5</li> <li>Scan Center Custom 6</li> <li>Scan Center Custom 7</li> <li>Scan Center Custom 8</li> <li>Scan Center Custom 9</li> <li>Scan Center Custom 10</li> <li>Forms and Favorites</li> </ul>	<p>Control access to printer applications.</p>

**Local Accounts**

Menu item	Description
<p><b>Manage Groups/Permissions</b></p> <ul style="list-style-type: none"> <li>Add Group                             <ul style="list-style-type: none"> <li>Import Access Controls</li> <li>Function Access</li> <li>Administrative Menus</li> <li>Device Management</li> <li>Apps</li> </ul> </li> <li>All Users                             <ul style="list-style-type: none"> <li>Import Access Controls</li> <li>Function Access</li> <li>Administrative Menus</li> <li>Device Management</li> <li>Apps</li> </ul> </li> <li>Admin</li> </ul>	<p>Control group or user access to the printer functions, applications, and security settings.</p>



Menu item	Description
<b>Add User</b> User Name/Password User Name Password PIN	Create local accounts to manage access to the printer functions.
<b>User Name/Password Accounts</b> Add User	
<b>User Name Accounts</b> Add User	
<b>Password Accounts</b> Add User	
<b>PIN Accounts</b> Add User	

### Schedule USB Devices

Menu item	Description
<b>Schedules</b> Add New Schedule	Schedule access to the USB ports.

### Security Audit Log

Menu item	Description
<b>Enable Audit</b> Off* On	Record the events in the secure audit log and remote syslog.
<b>Enable Remote Syslog</b> Off* On	Send audit logs to a remote server.
<b>Remote Syslog Server</b>	Specify the remote syslog server.
<b>Remote Syslog Port</b> 1-65535 (514*)	Specify the remote syslog port.
<b>Remote Syslog Method</b> Normal UDP* Stunnel	Specify a syslog method to transmit logged events to a remote server.

**Note:** An asterisk (\*) next to a value indicates the factory default setting.

Menu item	Description
<p><b>Remote Syslog Facility</b></p> <ul style="list-style-type: none"> <li>0 - Kernel Messages</li> <li>1 - User-Level Messages</li> <li>2 - Mail System</li> <li>3 - System Daemons</li> <li>4 - Security/Authorization Messages*</li> <li>5 - Messages Generated Internally by Syslogs</li> <li>6 - Line Printer Subsystem</li> <li>7 - Network News Subsystem</li> <li>8 - UUCP Subsystem</li> <li>9 - Clock Daemon</li> <li>10 - Security/Authorization Messages</li> <li>11 - FTP Daemon</li> <li>12 - NTP Subsystem</li> <li>13 - Log Audit</li> <li>14 - Log Alert</li> <li>15 - Clock Daemon</li> <li>16 - Local Use 0 (local0)</li> <li>17 - Local Use 1 (local1)</li> <li>18 - Local Use 2 (local2)</li> <li>19 - Local Use 3 (local3)</li> <li>20 - Local Use 4 (local4)</li> <li>21 - Local Use 5 (local5)</li> <li>22 - Local Use 6 (local6)</li> <li>23 - Local Use 7 (local7)</li> </ul>	<p>Specify a facility code that the printer uses when sending log events to a remote server.</p>
<p><b>Severity of Events to Log</b></p> <ul style="list-style-type: none"> <li>0 - Emergency</li> <li>1 - Alert</li> <li>2 - Critical</li> <li>3 - Error</li> <li>4 - Warning*</li> <li>5 - Notice</li> <li>6 - Informational</li> <li>7 - Debug</li> </ul>	<p>Specify the priority level cutoff for logging messages and events.</p>
<p><b>Remote Syslog Non-Logged Events</b></p> <ul style="list-style-type: none"> <li>Off*</li> <li>On</li> </ul>	<p>Send all events, regardless of severity level, to the remote server.</p>
<p><b>Admin's E-mail Address</b></p>	<p>Send e-mail notification of logged events to the administrator.</p>
<p><b>Note:</b> An asterisk (*) next to a value indicates the factory default setting.</p>	

Menu item	Description
<b>E-mail Log Cleared Alert</b> Off* On	Send e-mail notification to the administrator when a log entry is deleted.
<b>E-mail Log Wrapped Alert</b> Off* On	Send e-mail notification to the administrator when the log becomes full and begins to overwrite the oldest entries.
<b>Log Full Behavior</b> Wrap Over Older Entries* E-mail Log Then Delete All Entries	Resolve log storage issues when the log fills its allotted memory.
<b>E-mail % Full Alert</b> Off* On	Send e-mail notification to the administrator when the log fills its allotted memory.
<b>% Full Alert Level</b> 1–99 (90*)	
<b>E-mail Log Exported Alert</b> Off* On	Send e-mail notification to the administrator when a log is exported.
<b>E-mail Log Settings Changed Alert</b> Off* On	Send e-mail notification to the administrator when Enable Audit is set.
<b>Log Line Endings</b> LF (\n)* CR (\r) CRLF (\r\n)	Specify how the log file terminates the end of each line.
<b>Digitally Sign Exports</b> Off* On	Add a digital signature to each exported log file.
<b>Clear Log</b>	Delete all audit logs.
<b>Export Log</b> Syslog (RFC 5424) Syslog (RFC 3164) CSV	Export a security log to a flash drive.
<b>Note:</b> An asterisk (*) next to a value indicates the factory default setting.	

## Login Restrictions

Menu item	Description
<b>Login failures</b> 1–10 (3*)	Specify the number of failed login attempts before the user gets locked out.
<b>Failure time frame</b> 1–60 minutes (5*)	Specify the time frame between failed login attempts before the user gets locked out.
<b>Lockout time</b> 1–60 minutes (5*)	Specify the lockout duration.
<b>Web Login Timeout</b> 1–120 minutes (10*)	Specify the delay for a remote login before the user is logged off automatically.
<b>Note:</b> An asterisk (*) next to a value indicates the factory default setting.	

## Confidential Print Setup

Menu item	Description
<b>Max Invalid PIN</b> 2–10	Set the number of times an invalid PIN can be entered.  <b>Notes:</b> <ul style="list-style-type: none"> <li>• A value of zero turns off this setting.</li> <li>• When the limit is reached, the print jobs for that user name and PIN are deleted.</li> <li>• This menu item appears only when a hard disk is installed.</li> </ul>
<b>Confidential Job Expiration</b> Off* 1 Hour 4 Hours 24 Hours 1 Week	Set the expiration time for confidential print jobs.  <b>Notes:</b> <ul style="list-style-type: none"> <li>• If this menu item is changed while confidential print jobs reside in the printer memory or hard disk, then the expiration time for those print jobs does not change to the new default value.</li> <li>• If the printer is turned off, then all confidential jobs held in the printer memory are deleted.</li> </ul>
<b>Repeat Job Expiration</b> Off* 1 Hour 4 Hours 24 Hours 1 Week	Set the expiration time for a print job that you want to repeat.
<b>Verify Job Expiration</b> Off* 1 Hour 4 Hours 24 Hours 1 Week	Set the expiration time that the printer prints a copy for the user to examine its quality, before printing the remaining copies.
<b>Note:</b> An asterisk (*) next to a value indicates the factory default setting.	

Menu item	Description
<b>Reserve Job Expiration</b> Off* 1 Hour 4 Hours 24 Hours 1 Week	Set the expiration time that the printer stores print jobs for printing later.
<b>Require All Jobs to be Held</b> Off* On	Set the printer to hold all print jobs.
<b>Keep duplicate documents</b> Off* On	Set the printer to print other documents with the same file name without overwriting any of the print jobs.
<b>Note:</b> An asterisk (*) next to a value indicates the factory default setting.	

## Disk Encryption

**Note:** This menu appears only when a printer hard disk is installed.

Menu item	Description
<b>Status</b> Enabled Disabled	Determine whether Disk Encryption is enabled.
<b>Start encryption</b>	Prevent the loss of sensitive data in case the printer or its hard disk is stolen. <b>Note:</b> Enabling disk encryption erases all contents in the hard disk. If necessary, back up important data from the printer before starting the encryption.

## Erase Temporary Data Files

Menu item	Description
<b>Stored in onboard memory</b> Off* On	Delete all files stored on the printer memory.
<b>Stored on hard disk</b> 1 Pass Erase* 3 Pass Erase 7 Pass Erase	Delete all files stored on the printer hard disk.
<b>Note:</b> An asterisk (*) next to a value indicates the factory default setting.	

## Solutions LDAP Settings

Use	To
<b>Follow LDAP Referrals</b> Off* On	Search the different servers in the domain for the logged-in user account.
<b>LDAP Certificate Verification</b> No* Yes	Enable verification of LDAP certificates.

## Mobile Services Management

Use	To
<b>AirPrint</b> Print Scan Fax	Enable functions in the AirPrint software feature.

## Miscellaneous

Menu item	Description
<b>Protected Features</b> Show* Hide	Show all the features that Function Access Control (FAC) protects regardless of the security permission that the user has.  <b>Note:</b> FAC manages access to specific menus and functions or disables them entirely.
<b>Print Permission</b> Off* On	Let the user log in before printing.
<b>Default Print Permission Login</b>	Set the default login for Print Permission.
<b>Security Reset Jumper</b> Enable "Guest" access* No Effect	Specify the effect of using the security reset jumper.  <b>Notes:</b> <ul style="list-style-type: none"> <li>• The jumper is located beside a lock icon on the controller board.</li> <li>• Enable "Guest" access provides full access control to users who are not logged in.</li> <li>• No Effect means that the reset has no effect on the printer security configuration.</li> </ul>
<b>Minimum Password Length</b> 0–32 (0*)	Specify the minimum characters that are allowed for a password.
<b>Note:</b> An asterisk (*) next to a value indicates the factory default setting.	

## Reports

### Menu Settings Page

Menu item	Description
<b>Menu Settings Page</b>	Print a report that contains the printer preferences, settings, and configurations.

### Device

Menu item	Description
<b>Device Information</b>	Print a report that contains information about the printer.
<b>Device Statistics</b>	Print a report about printer usage and supply status.
<b>Profiles List</b>	Print a list of profiles that are stored in the printer.

### Print

Menu item	Description
<b>Print Fonts</b> PCL Fonts PS Fonts	Print samples and information about the fonts that are available in each printer language.
<b>Print Directory</b>	Print the resources that are stored in the flash drive or printer hard disk. <b>Note:</b> This menu item appears only when a flash drive or printer hard disk is installed.

### Shortcuts

Menu item	Description
<b>All Shortcuts</b>	Print a report that lists the shortcuts that are stored in the printer.
<b>Fax Shortcuts</b>	
<b>Copy Shortcuts</b>	
<b>E-mail Shortcuts</b>	
<b>FTP Shortcuts</b>	
<b>Network Folder Shortcuts</b>	

### Fax

Menu item	Description
<b>Fax Job Log</b>	Print a report about the last 200 completed fax jobs. <b>Note:</b> This menu item appears only when Enable Job Log is set to On.

Menu item	Description
<b>Fax Call Log</b>	Print a report about the last 100 attempted, received, and blocked calls. <b>Note:</b> This menu item appears only when Enable Job Log is set to On.

## Network

Menu item	Description
<b>Network Setup Page</b>	Print a page that shows the configured network and wireless settings on the printer. <b>Note:</b> This menu item appears only in network printers or printers connected to print servers.

## Help

Menu item	Description
Print All Guides	Prints all the guides
Media Guide	Provides information about loading paper and specialty media
Copy Guide	Provides information about making copies and configuring the settings
E-mail Guide	Provides information about sending e-mails and configuring the settings
Fax Guide	Provides information about sending faxes and configuring the settings
Scan Guide	Provides information about scanning documents and configuring the settings
Print Quality Guide	Provides information about solving print quality issues
Mono Quality Guide	Provides information about mono print quality settings
Information Guide	Provides more information sources about the printer
Connection Guide	Provides information about connecting the printer locally (USB) or to a network
Moving Guide	Provides information about moving, locating, or shipping the printer
Supplies Guide	Provides information about ordering supplies

## Troubleshooting

### Troubleshooting

Menu item	Description
<b>Print Quality Test Pages</b>	Print sample pages to identify and correct print quality defects.
<b>Cleaning the Scanner</b>	Print instructions on how to clean the scanner.



## Printing the Menu Settings Page

From the home screen, touch **Settings > Reports > Menu Settings Page**.

# Securing the printer

## Locating the security slot

The printer is equipped with a security lock feature. Attach a security lock compatible with most laptop computers in the location shown to secure the printer in place.

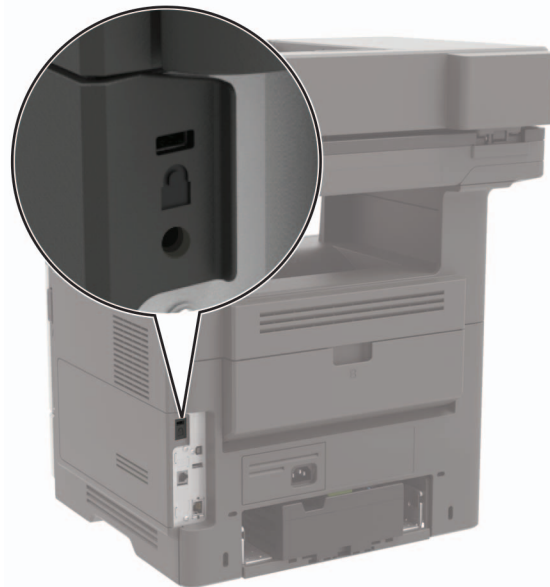

## Erasing printer memory

To erase volatile memory or buffered data in your printer, turn off the printer.

To erase non-volatile memory or individual settings, device and network settings, security settings, and embedded solutions, do the following:

- 1 From the home screen, touch **Settings > Device > Maintenance > Out of Service Erase**.
- 2 Select the **Sanitize all information on nonvolatile memory** check box, and then touch **ERASE**.
- 3 Follow the instructions on the display.

## Erasing printer hard disk memory

- 1 From the home screen, touch **Settings > Device > Maintenance > Out of Service Erase**.
- 2 Select the **Sanitize all information on hard disk** check box, and then touch **ERASE**.
- 3 Follow the instructions on the display.

**Note:** This process can take from several minutes to more than an hour, making the printer unavailable for other tasks.

## Configuring printer hard disk encryption

1 From the home screen, touch **Settings > Security > Disk Encryption > Start Encryption**.

**Note:** Enabling disk encryption erases the contents of the hard disk. If necessary, back up important data from the printer before starting the encryption.

2 Follow the instructions on the display.

**Notes:**

- Do not turn off the printer during the encryption process. Loss of data can occur.
- Disk encryption can take from several minutes to more than an hour, making the printer unavailable for other tasks.
- After encryption, the printer returns to the home screen.

## Restoring factory default settings

From the home screen, touch **Settings > Device > Restore Factory Defaults > Restore Settings > Restore all settings > RESTORE > Start**.

For more information, see [“Erasing printer memory” on page 138](#).

## Statement of Volatility

Type of memory	Description
Volatile memory	The printer uses standard random access memory (RAM) to buffer temporarily user data during simple print and copy jobs.
Non-volatile memory	The printer may use two forms of non-volatile memory: EEPROM and NAND (flash memory). Both types are used to store the operating system, printer settings, network information, scanner and bookmark settings, and embedded solutions.
Hard disk memory	Some printers may have a hard disk drive installed. The printer hard disk is designed for printer-specific functionality. The hard disk lets the printer retain buffered user data from complex print jobs, form data, and font data.

Erase the content of any installed printer memory in the following circumstances:

- The printer is decommissioned.
- The printer hard disk is replaced.
- The printer is moved to a different department or location.
- The printer is serviced by someone from outside your organization.
- The printer is removed from your premises for service.
- The printer is sold to another organization.

**Disposing of a printer hard disk**

- **Degaussing**—Flushes the hard disk with a magnetic field that erases stored data
- **Crushing**—Physically compresses the hard disk to break component parts and render them unreadable
- **Milling**—Physically shreds the hard disk into small metal bits

**Note:** To guarantee that all data are completely erased, destroy physically each hard disk where data is stored.

# Maintaining the printer

**Warning—Potential Damage:** Failure to maintain optimum printer performance, or to replace parts and supplies, may cause damage to your printer.

## Adjusting the speaker volume

### Adjusting the default internal speaker volume

**Note:** The speaker is available only in some printer models.

- 1 From the control panel, touch **Settings > Device > Preferences > Audio Feedback**.
- 2 Adjust the volume.

**Notes:**

- If Quiet Mode is enabled, then audible alerts are turned off. This setting also slows the printer performance.
- The volume resets to the default value after the session is logged out or when the printer wakes from Sleep or Hibernate mode.

### Adjusting the default headphone volume

**Note:** The headphone jack is available only in some printer models.

- 1 From the control panel, navigate to:  
**Settings > Device > Accessibility**
- 2 Adjust Headphone Volume.

**Note:** The volume resets to the default value after the session is logged out or when the printer wakes from Sleep or Hibernate mode.

### Configuring the fax speaker settings

**Note:** This feature is available only in some printer models.

- 1 From the control panel, navigate to:  
**Settings > Fax > Analog Fax Setup > Speaker Settings**

For non-touch-screen printer models, press  to navigate through the settings.

- 2 Do the following:
  - Set the Speaker Mode to **Always On**.
  - Set the Speaker Volume to **High**.
  - Activate the Ringer Volume.

# Networking

## Connecting the printer to a Wi-Fi network

1 From the printer control panel, navigate to:

**Settings > Network/Ports > Wireless**

For non-touch-screen printer models, press  to navigate through the settings.

2 Select **Setup On Printer Panel** and then follow the instructions on the display.

**Note:** For Wi-Fi-network-ready printer models, a prompt for Wi-Fi network setup appears during initial setup.

## Connecting the printer to a wireless network using Wi-Fi Protected Setup (WPS)

Before you begin, make sure that:

- The access point (wireless router) is WPS-certified or WPS-compatible. For more information, see the documentation that came with your access point.
- A wireless network adapter is installed in your printer. For more information, see the instructions that came with the adapter.

### Using the Push Button method

1 From the control panel, navigate to:

**Settings > Network/Ports > Wireless > Wi-Fi Protected Setup > Start Push Button Method**

2 Follow the instructions on the display.

### Using the personal identification number (PIN) method

1 From the control panel, navigate to:

**Settings > Network/Ports > Wireless > Wi-Fi Protected Setup > Start PIN Method**

2 Copy the eight-digit WPS PIN.

3 Open a Web browser, and then type the IP address of your access point in the address field.

#### Notes:

- View the printer IP address on the printer home screen. The IP address appears as four sets of numbers separated by periods, such as 123.123.123.123.
- If you are using a proxy server, then temporarily disable it to load the Web page correctly.

4 Access the WPS settings. For more information, see the documentation that came with your access point.

5 Enter the eight-digit PIN, and then save the changes.

## Deactivating the Wi-Fi network

1 From the printer control panel, navigate to:

**Settings > Network/Ports > Network Overview > Active Adapter > Standard Networking**

For non-touch-screen printer models, press  to navigate through the settings.

2 Follow the instructions on the display.

## Changing the printer port settings after installing an internal solutions port

### Notes:

- If the printer has a static IP address, then do not change the configuration.
- If the computers are configured to use the network name instead of an IP address, then do not change the configuration.
- If you are adding a wireless internal solutions port (ISP) to a printer previously configured for an Ethernet connection, then disconnect the printer from the Ethernet network.

### For Windows users

- 1 Open the printers folder.
- 2 From the shortcut menu of the printer with the new ISP, open the printer properties.
- 3 Configure the port from the list.
- 4 Update the IP address.
- 5 Apply the changes.

### For Macintosh users

- 1 From System Preferences in the Apple menu, navigate to the list of printers, and then select + > **IP**.
- 2 Type the IP address in the address field.
- 3 Apply the changes.

## Setting up serial printing (Windows only)

- 1 Set the parameters in the printer.
  - a From the control panel, navigate to the menu for the port settings.
  - b Locate the menu for the serial port settings, and then adjust the settings, if necessary.
  - c Apply the changes.
- 2 From your computer, open the printers folder, and then select your printer.
- 3 Open the printer properties, and then select the COM port from the list.
- 4 Set the COM port parameters in Device Manager.

### Notes:

- Serial printing reduces printing speed.

- Make sure that the serial cable is connected to the serial port on your printer.

## Cleaning printer parts

### Cleaning the printer



**CAUTION—SHOCK HAZARD:** To avoid the risk of electrical shock when cleaning the exterior of the printer, unplug the power cord from the electrical outlet and disconnect all cables from the printer before proceeding.

#### Notes:

- Perform this task after every few months.
- Damage to the printer caused by improper handling is not covered by the printer warranty.

- 1** Turn off the printer, and then unplug the power cord from the electrical outlet.
- 2** Remove paper from the standard bin and multipurpose feeder.
- 3** Remove any dust, lint, and pieces of paper around the printer using a soft brush or vacuum.
- 4** Wipe the outside of the printer with a damp, soft, lint-free cloth.

#### Notes:

- Do not use household cleaners or detergents, as they may damage the finish of the printer.
- Make sure that all areas of the printer are dry after cleaning.

- 5** Connect the power cord to the electrical outlet, and then turn on the printer.



**CAUTION—POTENTIAL INJURY:** To avoid the risk of fire or electrical shock, connect the power cord to an appropriately rated and properly grounded electrical outlet that is near the product and easily accessible.



## Cleaning the scanner

- 1 Open the scanner cover.



- 2 Using a damp, soft, lint-free cloth, wipe the following areas:

- ADF glass



- ADF glass pad



- Scanner glass



- Scanner glass pad



**3** Close the scanner cover.

**4** Open the ADF cover.

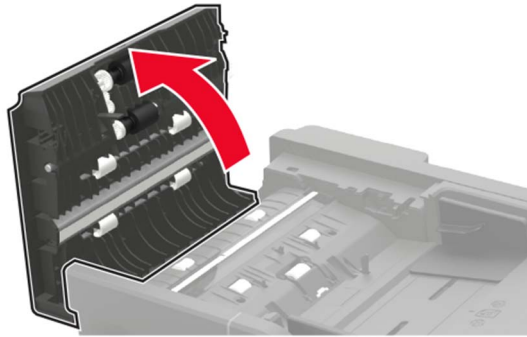

**5** Using a damp, soft, lint-free cloth, wipe the following areas:

- ADF glass pad in the ADF cover

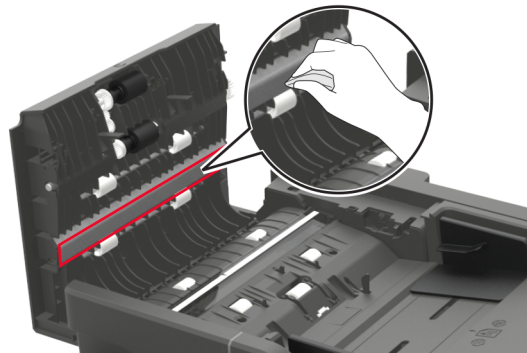

- ADF glass in the ADF cover

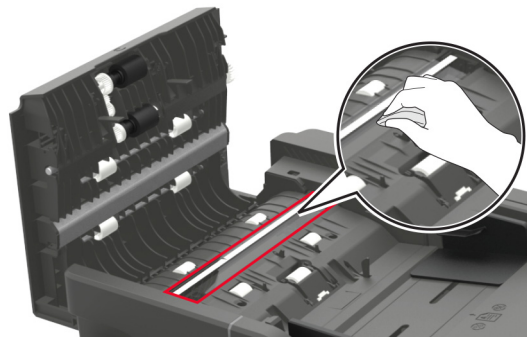

**6** Close the ADF cover.

## Ordering parts and supplies

To order parts and supplies in the U.S., contact 1-800-539-6275 for information about Lexmark authorized dealers in your area. In other countries or regions, go to [www.lexmark.com](http://www.lexmark.com) or contact the place where you purchased the printer.

**Note:** All life estimates for printer supplies assume printing on letter- or A4-size plain paper.

## Using genuine Lexmark parts and supplies

Your Lexmark printer is designed to function best with genuine Lexmark parts and supplies. Use of third-party supplies or parts may affect the performance, reliability, or life of the printer and its imaging components. It can also affect warranty coverage. Damage caused by the use of third-party parts and supplies is not covered by the warranty. All life indicators are designed to function with Lexmark parts and supplies, and may deliver unpredictable results if third-party parts and supplies are used. Imaging component usage beyond the intended life may damage your Lexmark printer or its associated components.

## Checking the status of parts and supplies

- From the control panel, navigate to:  
**Settings > Reports > Device > Device Statistics**

For non-touch-screen printer models, press  to navigate through the settings.

- From the Supply Information section of the pages printed, check the status of parts and supplies.

## Ordering a toner cartridge

**Notes:**

- The estimated cartridge yield is based on the ISO/IEC 19752 standard.
- Extremely low print coverage for extended periods of time may negatively affect actual yield.

### MX622 Return Program toner cartridges

Item	United States and Canada	European Economic Area	Rest of Asia Pacific	Latin America	Rest of Europe, Middle East, and Africa	Australia and New Zealand
Return Program toner cartridge	56F1000	56F2000	56F3000	56F4000	56F5000	56F6000
High yield Return Program toner cartridge	56F1H00	56F2H00	56F3H00	56F4H00	56F5H00	56F6H00

Item	United States and Canada	European Economic Area	Rest of Asia Pacific	Latin America	Rest of Europe, Middle East, and Africa	Australia and New Zealand
Extra high yield Return Program toner cartridge	56F1X00	56F2X00	56F3X00	56F4X00	56F5X00	56F6X00
Ultra high yield Return Program toner cartridge	56F1U00	56F2U00	56F3U00	56F4U00	56F5U00	56F6U00
High yield Corporate Return Program toner cartridge*	56F1H0E	56F2H0E	56F3H0E	56F4H0E	56F5H0E	56F6H0E
Extra high yield Corporate Return Program toner cartridge*	56F1X0E	56F2X0E	56F3X0E	56F4X0E	56F5X0E	56F6X0E
Ultra high yield Corporate Return Program toner cartridge*	56F1U0E	56F2U0E	56F3U0E	56F4U0E	56F5U0E	56F6U0E

\* This cartridge is available only for contract-managed printers. For more information, contact your Lexmark representative or system administrator.

**MX622 regular toner cartridge**

Item	Worldwide
Regular toner cartridge	56F0UA0

**XM3250 Return Program toner cartridge**

Item	United States, Canada, Australia, and New Zealand	European Economic Area	Rest of Asia Pacific	Latin America
Return Program toner cartridge	24B6887	24B6890	24B6893	24B6896

**MB2650 Return Program toner cartridges**

Item	United States and Canada	European Economic Area	Rest of Asia Pacific	Latin America	Rest of Europe, Middle East, and Africa	Australia and New Zealand
Return Program toner cartridge	SB231000	SB232000	SB233000	SB234000	SB235000	SB236000
High yield Return Program toner cartridge	SB241H00	SB242H00	SB243H00	SB244H00	SB245H00	SB246H00
Extra high yield Return Program toner cartridge	SB251X00	SB252X00	SB253X00	SB254X00	SB255X00	SB256X00
Ultra high yield Return Program toner cartridge	SB261U00	SB262U00	SB263U00	SB264U00	SB265U00	SB266U00

**MB2650 Regular toner cartridge**

Item	Worldwide
Regular toner cartridge	SB260UA0

**Ordering an imaging unit**

Extremely low print coverage for extended periods of time may cause imaging unit parts to fail before the toner is exhausted.

Item	Part Number
Return Program imaging unit	56F0Z00
Regular imaging unit	56F0ZA0
Corporate Return Program imaging unit*	56F0Z0E

\* This imaging unit is available only for contract-managed printers. For more information, contact your Lexmark representative or system administrator.

**Ordering a maintenance kit**

Match the maintenance kit to the printer voltage.

**Notes:**

- Using certain types of paper may require more frequent replacement of the maintenance kit.
- The maintenance kit includes a fuser, MPF pick roller and separator pad, pick tires, separator roller assembly, and transfer roller. These parts may be individually ordered and replaced if necessary.

Item	Part number
200K maintenance kit, 100 V	41X1227
200K maintenance kit, 110 V	41X1225
200K maintenance kit, 220 V	41X1226

**Note:** Only an authorized service technician can replace the maintenance kit. Contact your service provider.

## Ordering staple cartridges

Part name	Part number
Staple cartridges	35S8500

## Configuring supply notifications

- 1 Open a web browser, and then type the printer IP address in the address field.

**Notes:**

- View the printer IP address on the printer home screen. The IP address appears as four sets of numbers separated by periods, such as 123.123.123.123.
- If you are using a proxy server, then temporarily disable it to load the web page correctly.

- 2 Click **Settings > Device > Notifications**.
- 3 From the Supplies menu, click **Custom Supply Notifications**.
- 4 Select a notification for each supply item.
- 5 Apply the changes.

## Replacing supplies

### Replacing the toner cartridge

- 1 Open door A.

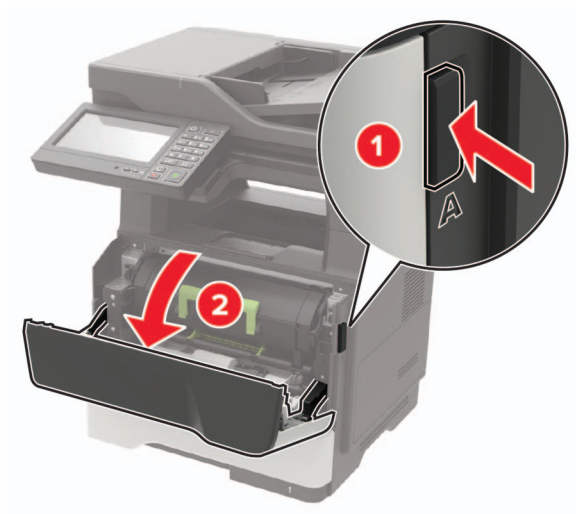

- 2 Remove the used toner cartridge.





- 3** Unpack the new toner cartridge, and then shake it three times to redistribute the toner.

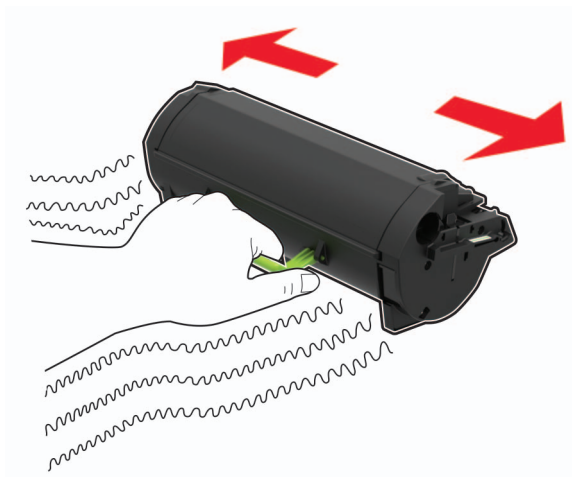

- 4** Insert the new toner cartridge.

**Note:** Use the arrows inside the printer as guides.



- 5** Close door A.

## Replacing the imaging unit

1 Open door A.

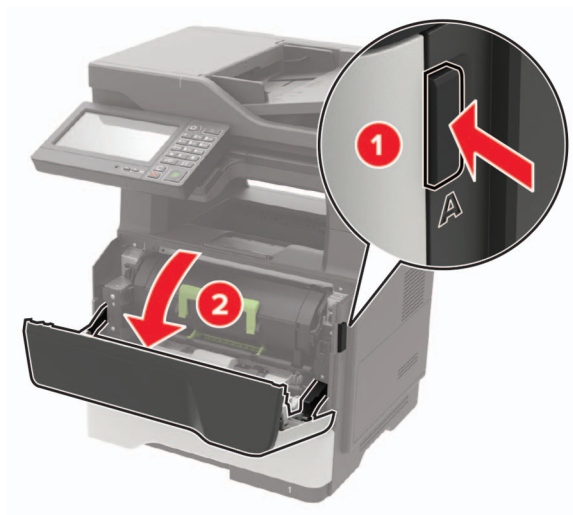

2 Remove the toner cartridge.



3 Remove the used imaging unit.



- 4 Unpack the new imaging unit, and then shake it three times to redistribute the toner.

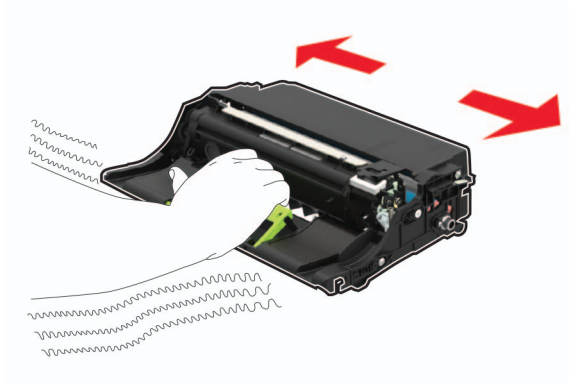

**Warning—Potential Damage:** Do not expose the imaging unit to direct light for more than 10 minutes. Extended exposure to light may cause print quality problems.

**Warning—Potential Damage:** Do not touch the photoconductor drum. Doing so may affect the quality of future print jobs.



- 5 Insert the new imaging unit.

**Note:** Use the arrows inside the printer as guides.



- 6 Insert the toner cartridge.

**Note:** Use the arrows inside the printer as guides.



**7** Close door A.

## Replacing the staple cartridge

**1** Open the stapler access door.

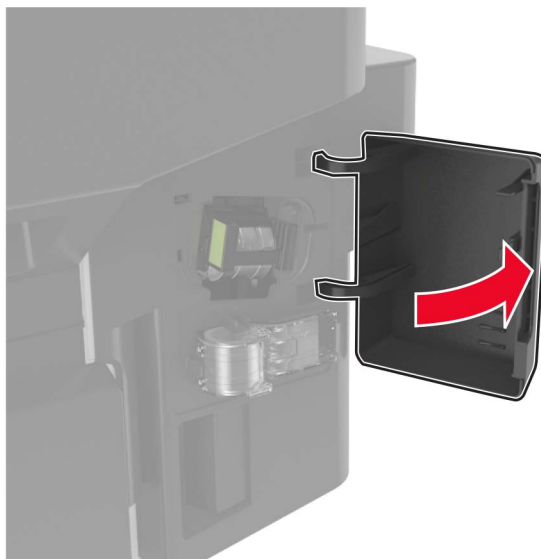

**2** Remove the staple cartridge.

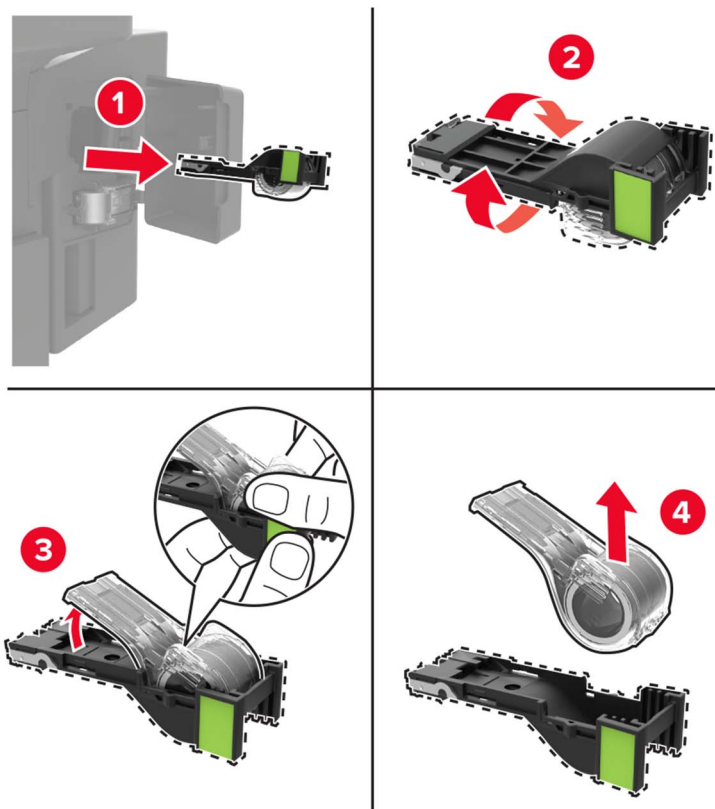

**3** Remove the spare staple cartridge.

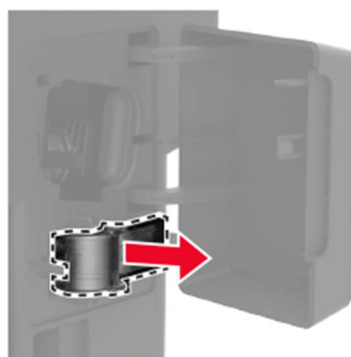

4 Insert the spare staple cartridge.

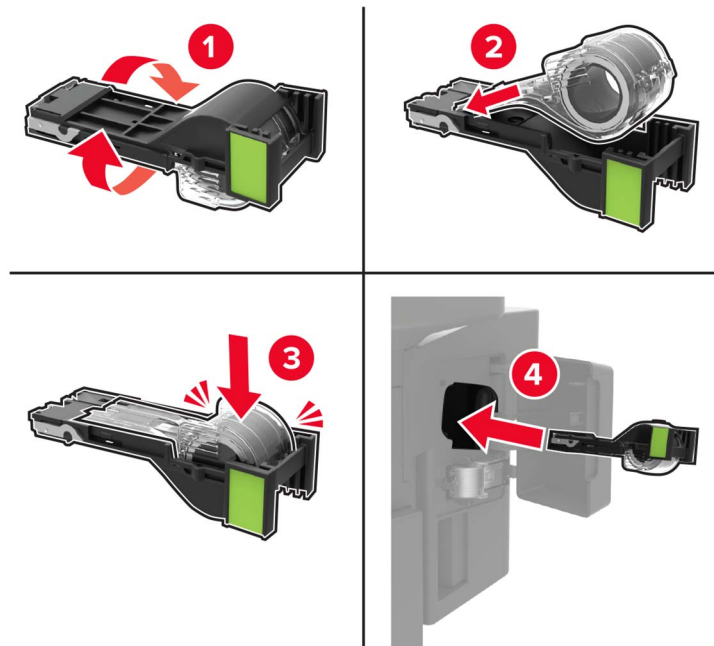

**Note:** Replace the spare staple cartridge for future use.

5 Close the stapler access door.

## Replacing the pick tires

- 1 Turn off the printer.
- 2 Unplug the power cord from the electrical outlet, and then from the printer.
- 3 Remove the tray.

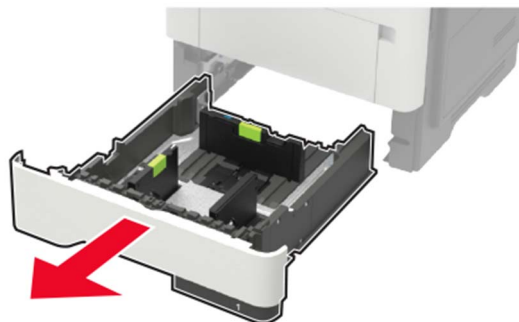

4 Remove the used pick tires one after the other.

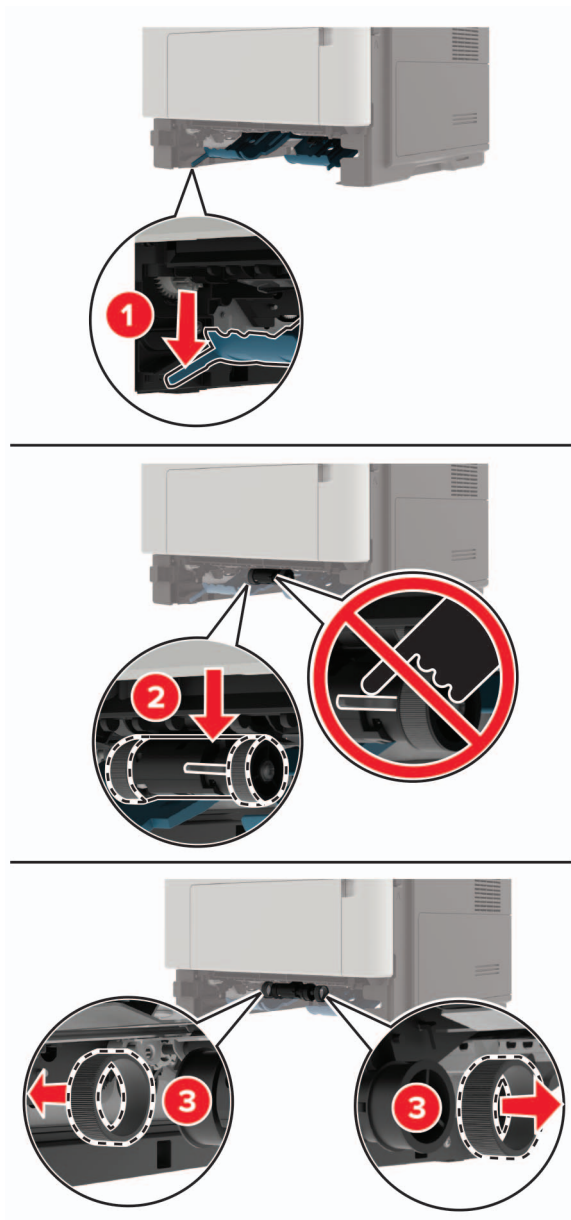

5 Unpack the new pick tires.

- 6 Insert the new pick tires.

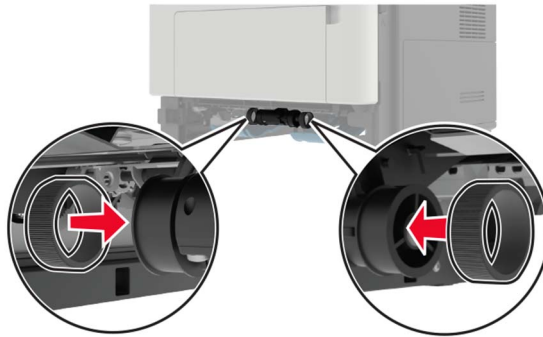

- 7 Insert the tray.
- 8 Connect the power cord to the printer, and then to the electrical outlet.

**⚠ CAUTION—POTENTIAL INJURY:** To avoid the risk of fire or electrical shock, connect the power cord to an appropriately rated and properly grounded electrical outlet that is near the product and easily accessible.

- 9 Turn on the printer.

## Replacing the pick roller assembly

- 1 Turn off the printer.
- 2 Unplug the power cord from the electrical outlet, and then from the printer.
- 3 Remove the optional tray.

**⚠ CAUTION—POTENTIAL INJURY:** If the printer weight is greater than 18 kg (40 lb), then it requires two or more trained personnel to lift it safely.



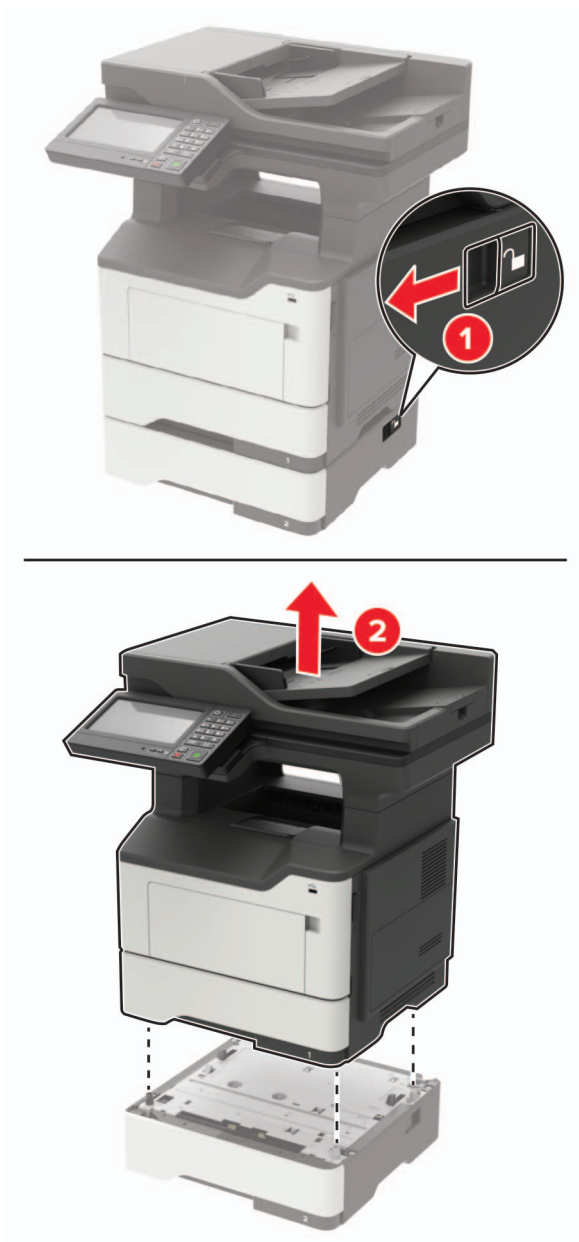

**4** Remove the tray insert, and then flip the tray base.

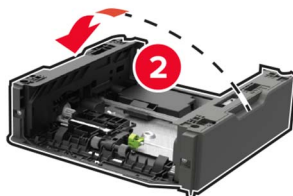
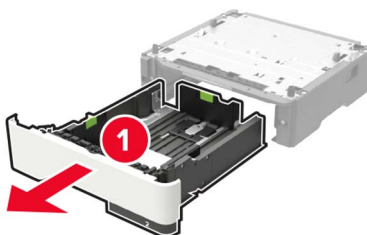

**5** Remove the used pick roller assembly.

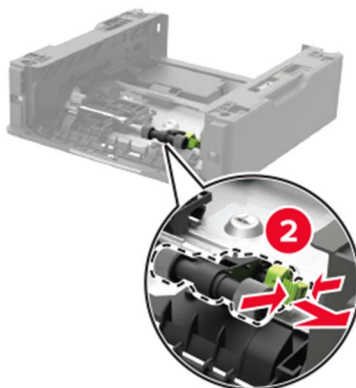
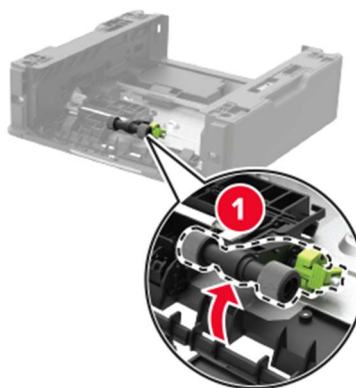

**6** Unpack the new pick roller assembly.

**7** Insert the new pick roller assembly.

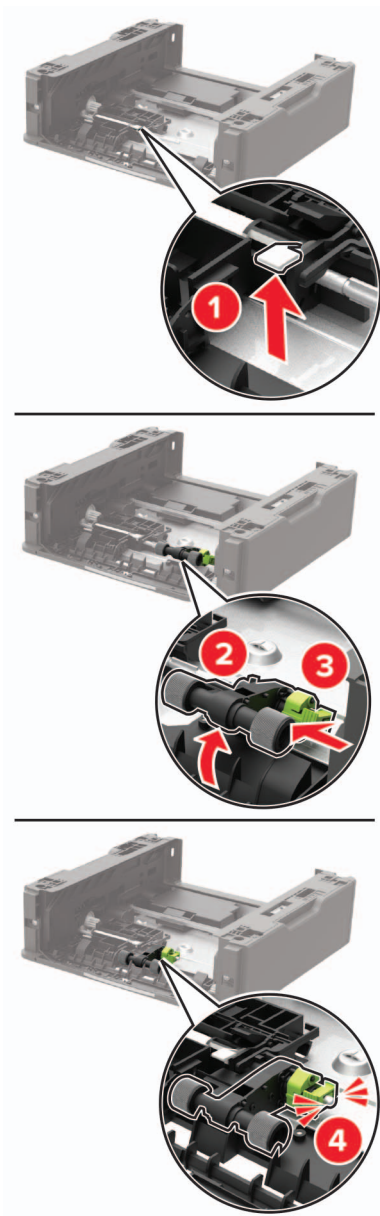

**8** Flip the tray base, and then insert the tray insert.

- 9 Align the printer with the optional tray, and then lower the printer until it *clicks* into place.



- 10 Connect the power cord to the printer, and then to the electrical outlet.

**CAUTION—POTENTIAL INJURY:** To avoid the risk of fire or electrical shock, connect the power cord to an appropriately rated and properly grounded electrical outlet that is near the product and easily accessible.

- 11 Turn on the printer.

## Moving the printer

### Moving the printer to another location

**CAUTION—POTENTIAL INJURY:** If the printer weight is greater than 18 kg (40 lb), then it requires two or more trained personnel to lift it safely.

**CAUTION—POTENTIAL INJURY:** To avoid the risk of fire or electrical shock, use only the power cord provided with this product or the manufacturer's authorized replacement.

**CAUTION—POTENTIAL INJURY:** When moving the printer, follow these guidelines to avoid personal injury or printer damage:

- Make sure that all doors and trays are closed.
- Turn off the printer, and then unplug the power cord from the electrical outlet.
- Disconnect all cords and cables from the printer.
- If the printer has separate floor-standing optional trays or output options attached to it, then disconnect them before moving the printer.
- If the printer has a caster base, then carefully roll it to the new location. Use caution when passing over thresholds and breaks in flooring.
- If the printer does not have a caster base but is configured with optional trays or output options, then remove the output options and lift the printer off the trays. Do not try to lift the printer and any options at the same time.
- Always use the handholds on the printer to lift it.

- Any cart used to move the printer must have a surface able to support the full footprint of the printer.
- Any cart used to move the hardware options must have a surface able to support the dimensions of the options.
- Keep the printer in an upright position.
- Avoid severe jarring movements.
- Make sure that your fingers are not under the printer when you set it down.
- Make sure that there is adequate clearance around the printer.

**Note:** Damage to the printer caused by improper moving is not covered by the printer warranty.

## Shipping the printer

For shipping instructions, go to <http://support.lexmark.com> or contact customer support.

## Saving energy and paper

### Setting up power saver modes

#### Eco-Mode

- 1 From the home screen, touch **Settings > Device > Power Management > Eco-Mode**.
- 2 Select a setting.

#### Sleep mode

- 1 From the home screen, touch **Settings > Device > Power Management > Timeouts > Sleep Mode**.
- 2 Enter the number of minutes the printer stays idle before it enters Sleep mode.

#### Hibernate mode

- 1 From the home screen, touch **Settings > Device > Power Management > Timeouts > Hibernate Timeout**.
- 2 Select the amount of time before the printer enters hibernate mode.

#### Notes:

- Make sure to wake the printer from hibernate mode before sending a print job.
- The Embedded Web Server is disabled when the printer is in hibernate mode.

## Adjusting the brightness of the printer display

- 1 From the home screen, touch **Settings > Device > Preferences > Screen Brightness**.
- 2 Adjust the setting.

## Conserving supplies

- Print on both sides of the paper.

**Note:** Two-sided printing is the default setting in the print driver.

- Print multiple pages on a single sheet of paper.
- Use the preview feature to see how the document looks like before printing it.
- Print one copy of the document to check its content and format for accuracy.

## Recycling

### Recycling Lexmark products

To return Lexmark products for recycling:

- 1 Go to [www.lexmark.com/recycle](http://www.lexmark.com/recycle).
- 2 Select the product you want to recycle.

**Note:** Printer supplies and hardware not listed in the Lexmark Collection and Recycling Program may be recycled through your local recycling center.

### Recycling Lexmark packaging

Lexmark continually strives to minimize packaging. Less packaging helps to ensure that Lexmark printers are transported in the most efficient and environmentally sensitive manner and that there is less packaging to dispose of. These efficiencies result in fewer greenhouse emissions, energy savings, and natural resource savings. Lexmark also offers recycling of packaging components in some countries or regions. For more information, go to [www.lexmark.com/recycle](http://www.lexmark.com/recycle), and then choose your country or region. Information on available packaging recycling programs is included with the information on product recycling.

Lexmark cartons are 100% recyclable where corrugated recycling facilities exist. Facilities may not exist in your area.

The foam used in Lexmark packaging is recyclable where foam recycling facilities exist. Facilities may not exist in your area.

When you return a cartridge to Lexmark, you can reuse the box that the cartridge came in. Lexmark recycles the box.

### Returning Lexmark cartridges for reuse or recycling

The Lexmark Cartridge Collection Program allows you to return used cartridges for free to Lexmark for reuse or recycling. One hundred percent of the empty cartridges returned to Lexmark are either reused or demanufactured for recycling. The boxes used to return the cartridges are also recycled.

To return Lexmark cartridges for reuse or recycling, do the following:

- 1 Go to [www.lexmark.com/recycle](http://www.lexmark.com/recycle).
- 2 Select the product that you want to recycle.

# Clearing jams

## Avoiding jams

### Load paper properly

- Make sure that the paper lies flat in the tray.

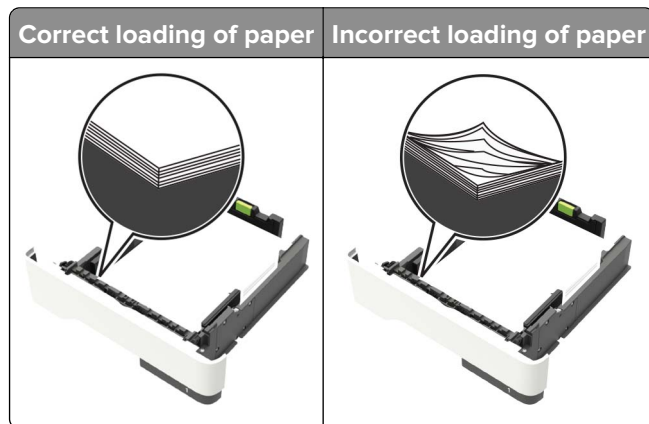

- Do not load or remove a tray while the printer is printing.
- Do not load too much paper. Make sure that the stack height is below the maximum paper fill indicator.
- Do not slide paper into the tray. Load paper as shown in the illustration.

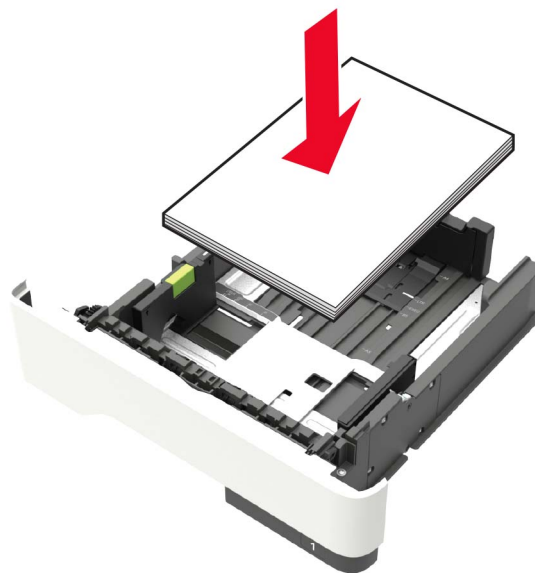

- Make sure that the paper guides are positioned correctly and are not pressing tightly against the paper or envelopes.
- Push the tray firmly into the printer after loading paper.

### Use recommended paper

- Use only recommended paper or specialty media.
- Do not load paper that is wrinkled, creased, damp, bent, or curled.
- Flex, fan, and align the paper edges before loading.

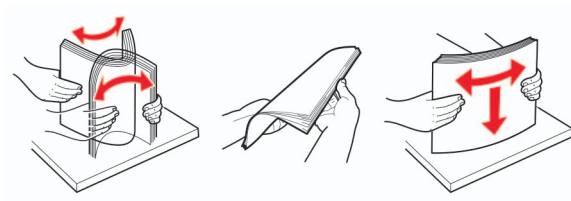

- Do not use paper that has been cut or trimmed by hand.
- Do not mix paper sizes, weights, or types in the same tray.
- Make sure that the paper size and type are set correctly on the computer or printer control panel.
- Store paper according to manufacturer recommendations.

## Identifying jam locations

### Notes:

- When Jam Assist is set to On, the printer automatically flushes blank pages or partially printed pages with after a jammed page is cleared. Check your printed output for blank pages.
- When Jam Recovery is set to On or Auto, the printer reprints jammed pages.

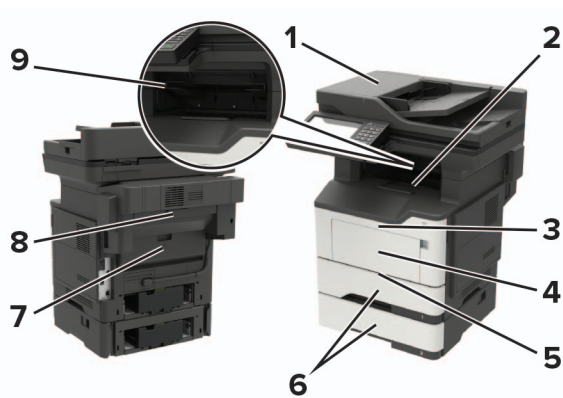

	Jam location
1	Automatic document feeder
2	Standard bin
3	Door A
4	Multipurpose feeder
5	Duplex unit
6	Trays
7	Door B



	Jam location
8	Optional staple finisher
9	Finisher bin

## Paper jam in door A

- 1 Remove the tray.

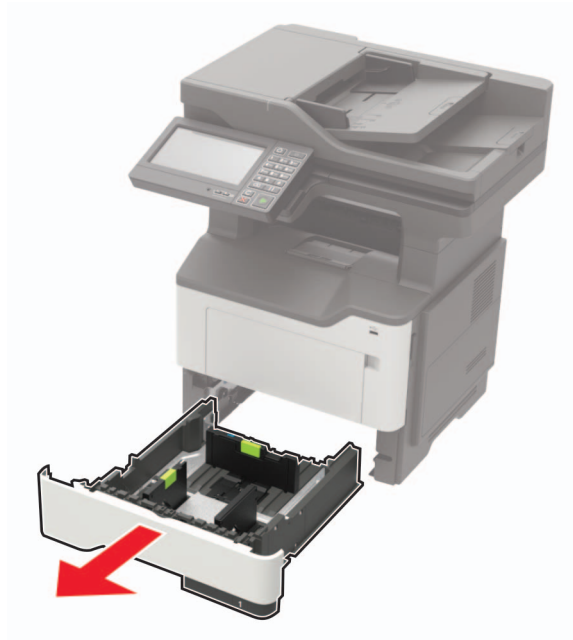

- 2 Open door A.

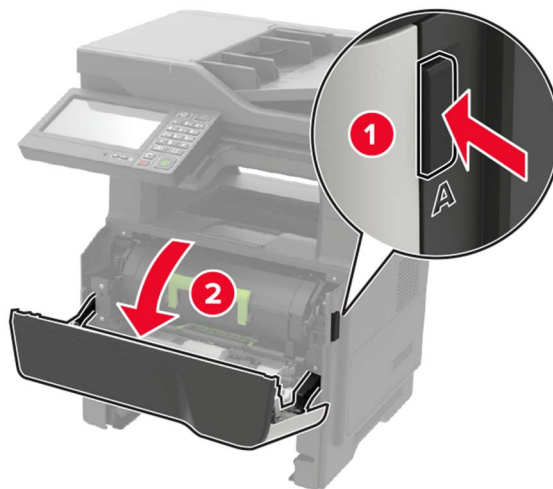

- 3 Remove the toner cartridge.



- 4 Remove the imaging unit.



**Warning—Potential Damage:** Do not expose the imaging unit to direct light for more than 10 minutes. Extended exposure to light may cause print quality problems.

**Warning—Potential Damage:** Do not touch the photoconductor drum. Doing so may affect the quality of future print jobs.



5 Remove the jammed paper.



**CAUTION—HOT SURFACE:** The inside of the printer might be hot. To reduce the risk of injury from a hot component, allow the surface to cool before touching it.

**Note:** Make sure that all paper fragments are removed.

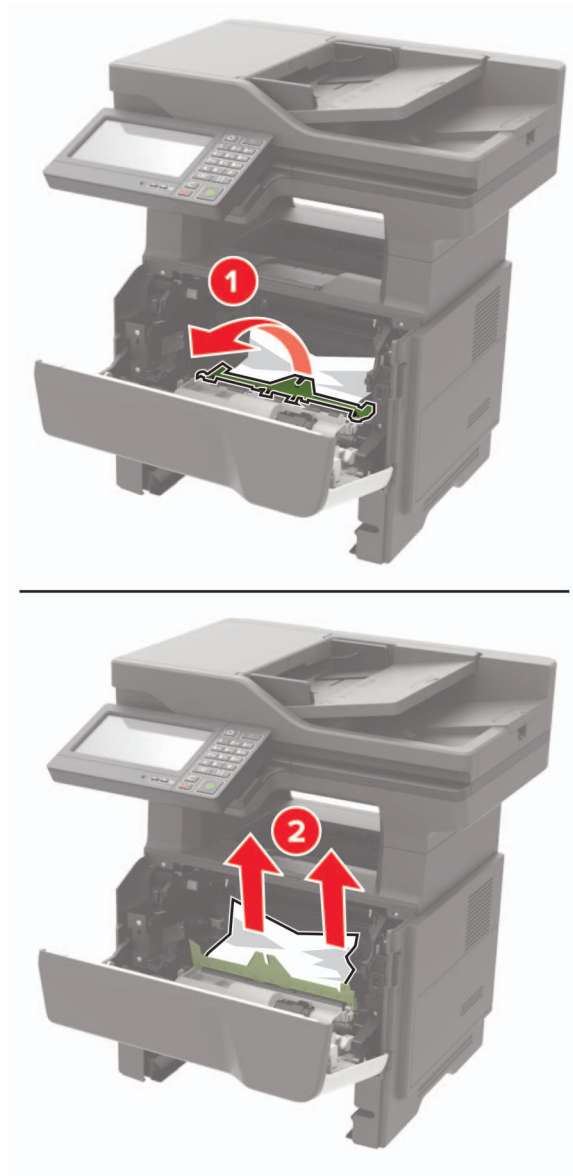

6 Insert the imaging unit.

**Note:** Use the arrows inside the printer as guides.



- 7 Insert the toner cartridge.

**Note:** Use the arrows inside the printer as guides.



- 8 Close door A.
- 9 Insert the tray.

## Paper jam in door B

- 1 Open door B.

 **CAUTION—HOT SURFACE:** The inside of the printer might be hot. To reduce the risk of injury from a hot component, allow the surface to cool before touching it.

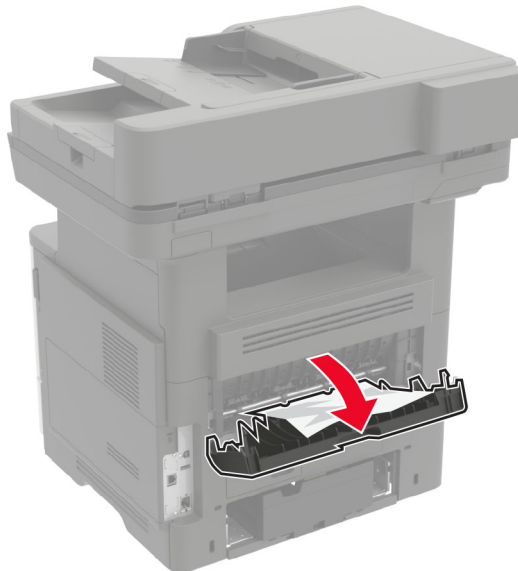

- 2 Remove the jammed paper.

**Note:** Make sure that all paper fragments are removed.

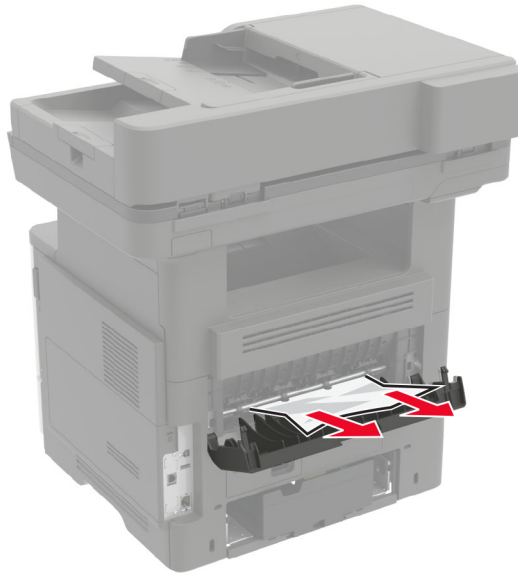

**3** Close door B.

## Paper jam in the standard bin

Remove the jammed paper.

**Note:** Make sure that all paper fragments are removed.



## Paper jam in the duplex unit

- 1 Remove the tray.

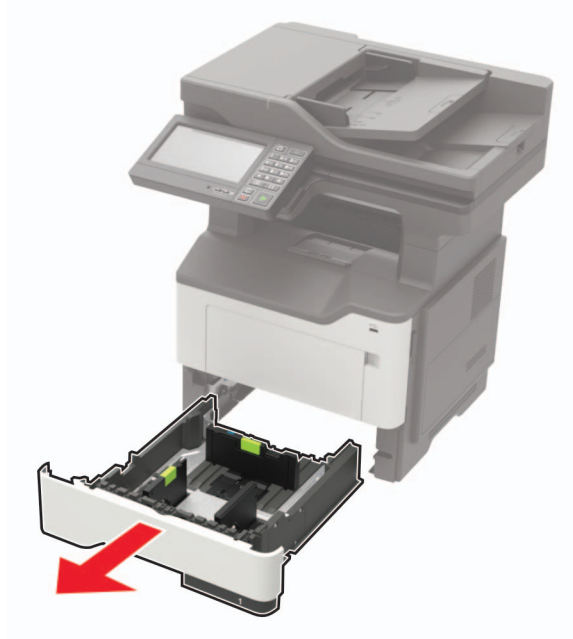

- 2 Remove the jammed paper.

**Note:** Make sure that all paper fragments are removed.



- 3 Insert the tray.

## Paper jam in trays

- 1 Remove the tray.

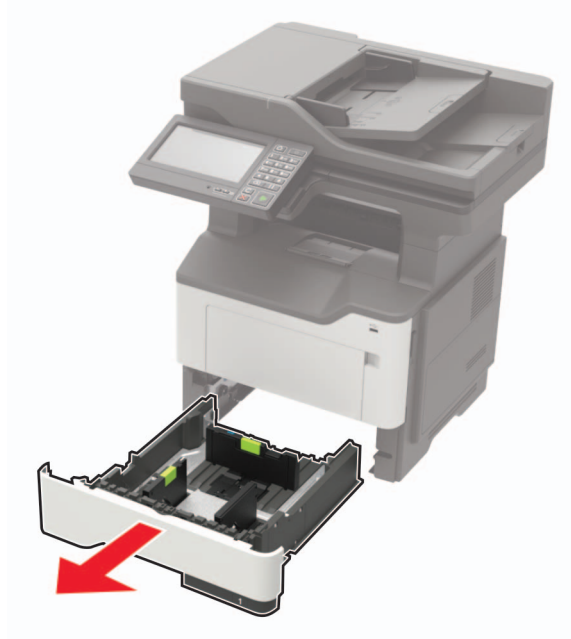

- 2 Remove the jammed paper.

**Note:** Make sure that all paper fragments are removed.

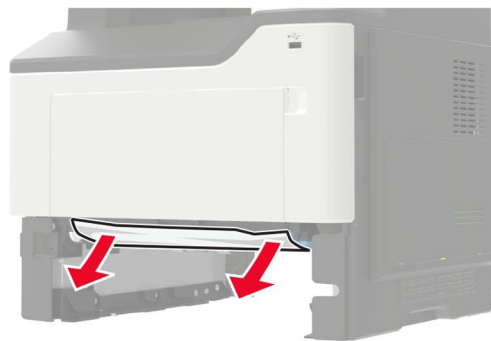

- 3 Insert the tray.

## Paper jam in the multipurpose feeder

- 1 Remove paper from the multipurpose feeder.
- 2 Remove the jammed paper.

**Note:** Make sure that all paper fragments are removed.





**3** Flex, fan, and align the paper edges before loading.

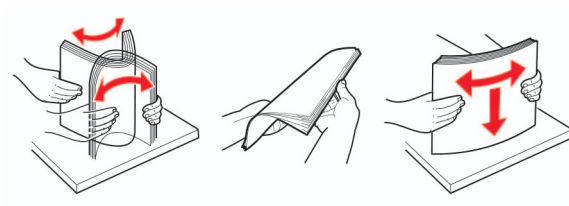

**4** Reload paper, and then adjust the paper guide.



## Paper jam in the automatic document feeder

- 1** Remove all original documents from the ADF tray.
- 2** Open the ADF cover.

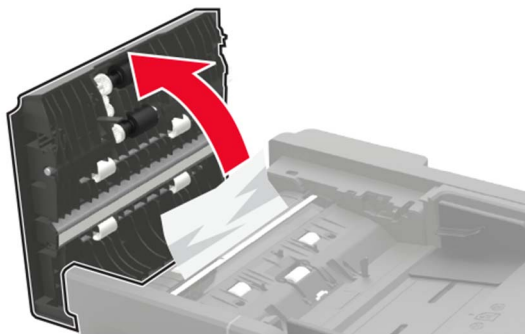

**3** Remove the jammed paper.

**Note:** Make sure that all paper fragments are removed.

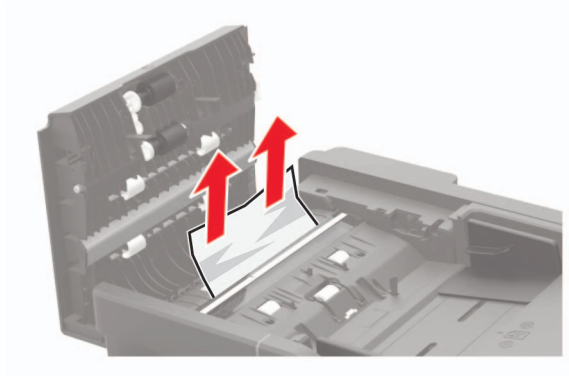

**4** Close the ADF cover.

## Paper jam in the finisher

### Paper jam in the finisher bin

**1** Remove paper from the finisher bin.



**2** Remove the jammed paper.

**Note:** Make sure that all paper fragments are removed.



## Paper jam in the finisher rear door

- 1 Open the finisher rear door.

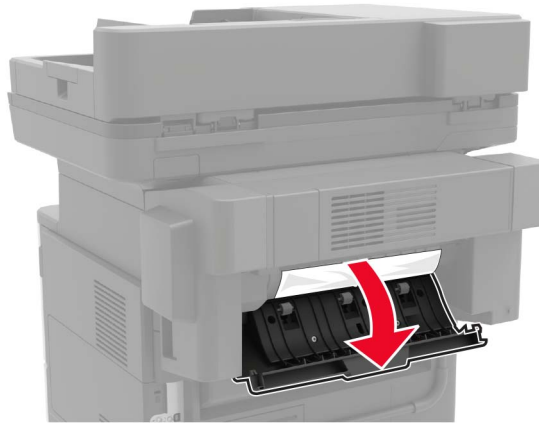

- 2 Remove the jammed paper.

**Note:** Make sure that all paper fragments are removed.

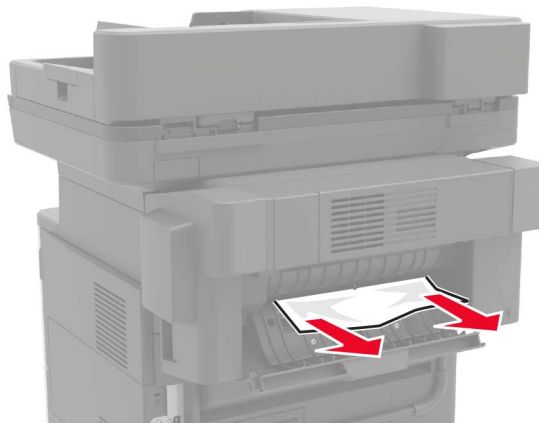

- 3 Open the finisher narrow door, and then remove any paper fragments.

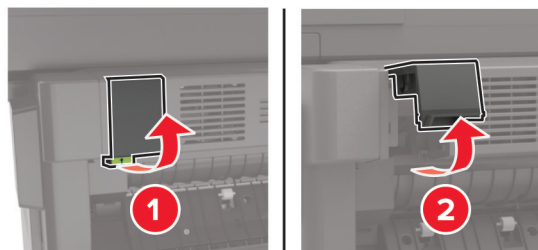

- 4 Close the doors.

## Staple jam in the finisher

- 1 Open the staple access door.

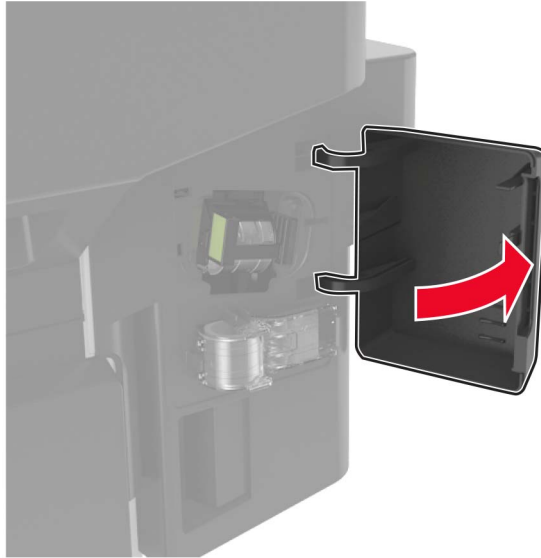

- 2 Remove the staple cartridge holder.



- 3 Lift the staple guard, and then remove the loose staples.

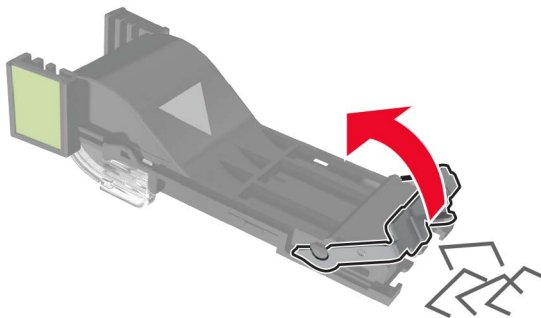

**4** Close the staple guard.

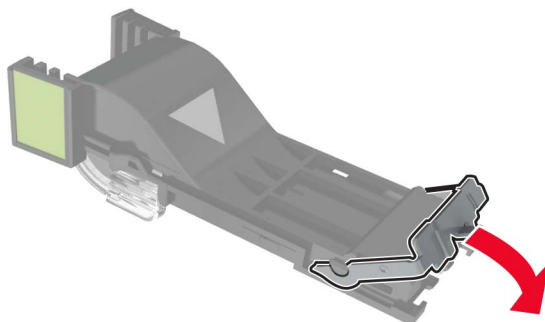

**5** Insert the staple cartridge holder.

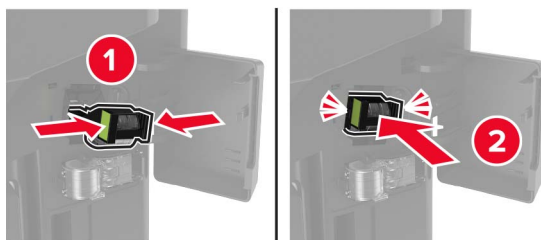

**6** Close the staple access door.

# Troubleshooting

## Network connection problems

### Cannot open Embedded Web Server

Action	Yes	No
<p><b>Step 1</b> Check if the printer is on.</p> <p>Is the printer on?</p>	Go to step 2.	Turn on the printer.
<p><b>Step 2</b> Make sure that the printer IP address is correct.</p> <p>View the printer IP address:</p> <ul style="list-style-type: none"> <li>• From the home screen</li> <li>• From the TCP/IP section in the Network/Ports menu</li> <li>• By printing a network setup page or menu settings page, and then finding the TCP/IP section</li> </ul> <p><b>Note:</b> An IP address appears as four sets of numbers separated by periods, such as 123.123.123.123.</p> <p>Is the printer IP address correct?</p>	Go to step 3.	Type the correct printer IP address in the address field.
<p><b>Step 3</b> Check if you are using a supported browser:</p> <ul style="list-style-type: none"> <li>• Internet Explorer® version 11 or later</li> <li>• Microsoft Edge™</li> <li>• Safari version 6 or later</li> <li>• Google Chrome™ version 32 or later</li> <li>• Mozilla Firefox version 24 or later</li> </ul> <p>Is your browser supported?</p>	Go to step 4.	Install a supported browser.
<p><b>Step 4</b> Check if the network connection is working.</p> <p>Is the network connection working?</p>	Go to step 5.	Contact your administrator.
<p><b>Step 5</b> Make sure that the cable connections to the printer and print server are secure. For more information, see the documentation that came with the printer.</p> <p>Are the cable connections secure?</p>	Go to step 6.	Secure the cable connections.

Action	Yes	No
<p><b>Step 6</b> Check if the web proxy servers are disabled.</p> <p>Are the web proxy servers disabled?</p>	Go to step 7.	Contact your administrator.
<p><b>Step 7</b> Access the Embedded Web Server.</p> <p>Did the Embedded Web Server open?</p>	The problem is solved.	Contact <a href="#">customer support</a> .

### Unable to read flash drive

Action	Yes	No
<p><b>Step 1</b> Check if the printer is not busy processing another print, copy, scan, or fax job.</p> <p>Is the printer ready?</p>	Go to step 2.	Wait for the printer to finish processing the other job.
<p><b>Step 2</b> Check if the flash drive is inserted into the front USB port.</p> <p><b>Note:</b> The flash drive does not work when it is inserted into the rear USB port.</p> <p>Is the flash drive inserted into the correct port?</p>	Go to step 3.	Insert the flash drive into the correct port.
<p><b>Step 3</b> Check if the flash drive is supported. For more information, see <a href="#">“Supported flash drives and file types” on page 35</a>.</p> <p>Is the flash drive supported?</p>	Go to step 4.	Insert a supported flash drive.
<p><b>Step 4</b></p> <p><b>a</b> Check if the USB port is enabled. For more information, see <a href="#">“Enabling the USB port” on page 183</a>.</p> <p><b>b</b> Remove, and then insert the flash drive.</p> <p>Does the printer recognize the flash drive?</p>	The problem is solved.	Contact <a href="#">customer support</a> .

### Enabling the USB port

From the home screen, touch **Settings > Network/Ports > USB > Enable USB Port**.

## Checking the printer connectivity

- 1 From the home screen, touch **Settings > Reports > Network > Network Setup Page**.
- 2 Check the first section of the network setup page, and confirm that the status is connected.  
If the status is not connected, then the LAN drop may be inactive, or the network cable may be malfunctioning. Contact your administrator for assistance.

## Hardware options problems

### Cannot detect internal option

Action	Yes	No
<p><b>Step 1</b> Turn off the printer, wait for about 10 seconds, and then turn on the printer.</p> <p>Does the internal option operate correctly?</p>	The problem is solved.	Go to step 2.
<p><b>Step 2</b> Print the Menu Settings Page, and then check if the internal option appears in the Installed Features list.</p> <p>Is the internal option listed in the menu settings page?</p>	Go to step 4.	Go to step 3.
<p><b>Step 3</b> Check if the internal option is installed properly into the controller board.</p> <ul style="list-style-type: none"> <li>a Turn off the printer, and then unplug the power cord from the electrical outlet.</li> <li>b Make sure that the internal option is installed in the appropriate connector in the controller board.</li> <li>c Connect the power cord to the electrical outlet, and then turn on the printer.</li> </ul> <p> <b>CAUTION—POTENTIAL INJURY:</b> To avoid the risk of fire or electrical shock, connect the power cord to an appropriately rated and properly grounded electrical outlet that is near the product and easily accessible.</p> <p>Does the internal option operate correctly?</p>	The problem is solved.	Go to step 4.



Action	Yes	No
<p><b>Step 4</b></p> <p><b>a</b> Check if the internal option is available in the print driver.</p> <p><b>Note:</b> If necessary, manually add the internal option in the print driver to make it available for print jobs. For more information, see <a href="#">“Adding available options in the print driver” on page 242.</a></p> <p><b>b</b> Resend the print job.</p> <p>Does the internal option operate correctly?</p>	<p>The problem is solved.</p>	<p>Contact <a href="#">customer support.</a></p>

### Internal solutions port does not operate correctly

Action	Yes	No
<p><b>Step 1</b></p> <p>Print a menu settings page, and then check if the internal solutions port (ISP) appears in the Installed Features list.</p> <p>Is the ISP listed in the Installed Features list?</p>	<p>Go to step 3.</p>	<p>Go to step 2.</p>
<p><b>Step 2</b></p> <p>Remove, and then install the ISP. For more information, see <a href="#">“Installing an internal solutions port” on page 234.</a></p> <p><b>Note:</b> Use a supported ISP.</p> <p>Does the ISP operate correctly?</p>	<p>The problem is solved.</p>	<p>Go to step 3.</p>
<p><b>Step 3</b></p> <p>Check the cable and the ISP connection.</p> <p><b>a</b> Use the correct cable, and then make sure that it is securely connected to the ISP.</p> <p><b>b</b> Check if the ISP solution interface cable is securely connected into the receptacle of the controller board.</p> <p>Does the ISP operate correctly?</p>	<p>The problem is solved.</p>	<p>Contact <a href="#">customer support.</a></p>

### Defective flash detected

Try one or more of the following:

- Replace the defective flash memory.
- From the printer control panel, select **Continue** to ignore the message and continue printing.
- Cancel the current print job.

## Not enough free space in flash memory for resources

Try one or more of the following:

- From the printer control panel, select **Continue** to clear the message and continue printing.
- Delete fonts, macros, and other data stored in the flash memory.
- Install flash memory with larger capacity.

**Note:** Downloaded fonts and macros that are not previously stored in the flash memory are deleted.

## Unformatted flash detected

Try one or more of the following:

- From the control panel, select **Continue** to stop the defragmentation and continue printing.
- Format the flash memory.

**Note:** If the error message remains, then the flash memory may be defective and needs to be replaced.

## Issues with supplies

### Replace cartridge, printer region mismatch

To correct this problem, purchase a cartridge with the correct region that matches the printer region, or purchase a worldwide cartridge.

- The first number in the message after 42 indicates the region of the printer.
- The second number in the message after 42 indicates the region of the cartridge.

#### Printer and toner cartridge regions

Region	Numeric code
Worldwide or Undefined region	0
North America (United States, Canada)	1
European Economic Area, Western Europe, Nordic countries, Switzerland	2
Asia Pacific	3
Latin America	4
Rest of Europe, Middle East, Africa	5
Australia, New Zealand	6
Invalid region	9

**Note:** To find the region settings of the printer and toner cartridge, print the print quality test pages. From the control panel, navigate to: **Settings > Troubleshooting > Print Quality Test Pages.**

## Non-Lexmark supply

The printer has detected a non-Lexmark supply or part installed in the printer.

Your Lexmark printer is designed to function best with genuine Lexmark supplies and parts. Use of third-party supplies or parts may affect the performance, reliability, or life of the printer and its imaging components.

All life indicators are designed to function with Lexmark supplies and parts and may deliver unpredictable results if third-party supplies or parts are used. Imaging component usage beyond the intended life may damage your Lexmark printer or associated components.

**Warning—Potential Damage:** Use of third-party supplies or parts can affect warranty coverage. Damage caused by the use of third-party supplies or parts may not be covered by the warranty.

To accept any and all of these risks and to proceed with the use of non-genuine supplies or parts in your printer, from the control panel, press and hold **X** and **#** simultaneously for 15 seconds.

If you do not want to accept these risks, then remove the third-party supply or part from your printer and install a genuine Lexmark supply or part. For more information, see [“Using genuine Lexmark parts and supplies” on page 148](#).

If the printer does not print after pressing and holding **X** and **#** simultaneously for 15 seconds, then reset the supply usage counter.

- 1 From the control panel, navigate to:  
**Settings > Device > Maintenance > Configuration Menu > Supply Usage And Counters**
- 2 Select the part or supply that you want to reset, and then select **Start**.
- 3 Read the warning message, and then select **Continue**.
- 4 Press and hold **X** and **#** simultaneously for 15 seconds to clear the message.

**Note:** If you are unable to reset the supply usage counters, then return the item to the place of purchase.

## Paper feed problems

### Envelope seals when printing

Action	Yes	No
<p><b>Step 1</b></p> <p><b>a</b> Use an envelope that has been stored in a dry environment. <b>Note:</b> Printing on envelopes with high moisture content can seal the flaps.</p> <p><b>b</b> Send the print job.</p> <p>Does the envelope seal when printing?</p>	Go to step 2.	The problem is solved.

Action	Yes	No
<p><b>Step 2</b></p> <p><b>a</b> Make sure that paper type is set to Envelope. From the control panel, navigate to: <b>Settings &gt; Paper &gt; Tray Configuration &gt; Paper Size/Type</b></p> <p>For non-touch-screen printer models, press  to navigate through the settings.</p> <p><b>b</b> Send the print job.</p> <p>Does the envelope seal when printing?</p>	<p>Contact <a href="#">customer support</a>.</p>	<p>The problem is solved.</p>

### Collated printing does not work

Action	Yes	No
<p><b>Step 1</b></p> <p><b>a</b> From the printer control panel, navigate to: <b>Settings &gt; Print &gt; Layout &gt; Collate</b></p> <p>For non-touch-screen printer models, press  to navigate through the settings.</p> <p><b>b</b> Set Collate to <b>On</b>.</p> <p><b>c</b> Print the document.</p> <p>Are the pages collated correctly?</p>	<p>The problem is solved.</p>	<p>Go to step 2.</p>
<p><b>Step 2</b></p> <p><b>a</b> From the document that you are trying to print, open the Print dialog, and then select <b>Collate</b>.</p> <p><b>b</b> Print the document.</p> <p>Are the pages collated correctly?</p>	<p>The problem is solved.</p>	<p>Go to step 3.</p>
<p><b>Step 3</b></p> <p><b>a</b> Reduce the number of pages to print.</p> <p><b>b</b> Print the document.</p> <p>Are the pages collated correctly?</p>	<p>The problem is solved.</p>	<p>Contact <a href="#">customer support</a>.</p>

### Tray linking does not work

Action	Yes	No
<p><b>Step 1</b></p> <p><b>a</b> Check if the trays contain the same paper size and paper type.</p> <p><b>b</b> Check if the paper guides are positioned correctly.</p> <p><b>c</b> Print the document.</p> <p>Do the trays link correctly?</p>	The problem is solved.	Go to step 2.
<p><b>Step 2</b></p> <p><b>a</b> From the control panel, navigate to:  <b>Settings &gt; Paper &gt; Tray Configuration &gt; Paper Size/Type</b></p> <p>For non-touch-screen printer models, press  to navigate through the settings.</p> <p><b>b</b> Set the paper size and paper type to match the paper loaded in the linked trays.</p> <p><b>c</b> Print the document.</p> <p>Do the trays link correctly?</p>	The problem is solved.	Go to step 3.
<p><b>Step 3</b></p> <p><b>a</b> Make sure that Tray Linking is set to Automatic. For more information, see <a href="#">“Linking trays” on page 29</a>.</p> <p><b>b</b> Print the document.</p> <p>Do the trays link correctly?</p>	The problem is solved.	Contact <a href="#">customer support</a> .

### Paper frequently jams

Action	Yes	No
<p><b>Step 1</b></p> <p><b>a</b> Remove the tray.</p> <p><b>b</b> Check if paper is loaded correctly.</p> <p><b>Notes:</b></p> <ul style="list-style-type: none"> <li>• Make sure that the paper guides are positioned correctly.</li> <li>• Make sure that the stack height is below the maximum paper fill indicator.</li> <li>• Make sure to print on recommended paper size and type.</li> </ul> <p><b>c</b> Insert the tray.</p> <p><b>d</b> Print the document.</p> <p>Do paper jams occur frequently?</p>	Go to step 2.	The problem is solved.

Action	Yes	No
<p><b>Step 2</b></p> <p><b>a</b> From the control panel, navigate to:  <b>Settings &gt; Paper &gt; Tray Configuration &gt; Paper Size/Type</b></p> <p>For non-touch-screen printer models, press  to navigate through the settings.</p> <p><b>b</b> Set the correct paper size and type.</p> <p><b>c</b> Print the document.</p> <p>Do paper jams occur frequently?</p>	<p>Go to step 3.</p>	<p>The problem is solved.</p>
<p><b>Step 3</b></p> <p><b>a</b> Load paper from a fresh package.</p> <p><b>Note:</b> Paper absorbs moisture due to high humidity. Store paper in its original wrapper until you are ready to use it.</p> <p><b>b</b> Print the document.</p> <p>Do paper jams occur frequently?</p>	<p>Contact <a href="#">customer support</a>.</p>	<p>The problem is solved.</p>

### Jammed pages are not reprinted

Action	Yes	No
<p><b>a</b> From the home screen, touch <b>Settings &gt; Device &gt; Notifications &gt; Jam Content Recovery</b>.</p> <p><b>b</b> Select <b>On</b> or <b>Auto</b>.</p> <p><b>c</b> Apply the changes.</p> <p>Are the jammed pages reprinted?</p>	<p>The problem is solved.</p>	<p>Contact <a href="#">customer support</a>.</p>

## Printing problems

### Print quality is poor

#### Blank or white pages



**Note:** Before solving the problem, print the Print Quality Test Pages. From the control panel, navigate to **Settings > Troubleshooting > Print Quality Test Pages**. For non-touch-screen printer models, press  to navigate through the settings.

Action	Yes	No
<p><b>Step 1</b></p> <p><b>a</b> Check if the printer is using a genuine and supported Lexmark toner cartridge.</p> <p><b>Note:</b> If the cartridge is not supported, then install a supported one.</p> <p><b>b</b> Print the document.</p> <p>Is the printer printing blank or white pages?</p>	Go to step 2.	The problem is solved.
<p><b>Step 2</b></p> <p><b>a</b> Remove any packing material that is left on the imaging unit.</p> <p><b>1</b> Remove the toner cartridge, and then remove the imaging unit.</p> <p><b>Warning—Potential Damage:</b> Do not expose the imaging unit to direct light for more than 10 minutes. Extended exposure to light may cause print quality problems.</p> <p><b>Warning—Potential Damage:</b> Do not touch the photoconductor drum under the imaging unit. Doing so may affect the quality of future print jobs.</p> <p><b>2</b> Check the imaging unit for signs of damage, and replace if necessary.</p> <p><b>Note:</b> Make sure that the photoconductor drum contact is not bent or out of place.</p> <p><b>3</b> Firmly shake the imaging unit to redistribute the toner.</p> <p><b>4</b> Insert the imaging unit, and then insert the toner cartridge.</p> <p><b>b</b> Print the document.</p> <p>Is the printer printing blank or white pages?</p>	Go to step 3.	The problem is solved.
<p><b>Step 3</b></p> <p>Check the status of the toner cartridge, and replace if necessary.</p> <p><b>a</b> From the control panel, navigate to:</p> <p><b>Status/Supplies &gt; Supplies</b></p> <p><b>b</b> Print the document.</p> <p>Is the printer printing blank or white pages?</p>	Contact <a href="#">customer support</a> .	The problem is solved.

## Dark print

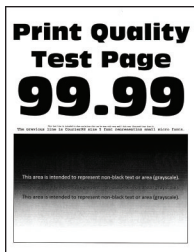

**Note:** Before solving the problem, print the Print Quality Test Pages. From the control panel, navigate to **Settings > Troubleshooting > Print Quality Test Pages**. For non-touch-screen printer models, press **OK** to navigate through the settings.

Action	Yes	No
<p><b>Step 1</b></p> <p><b>a</b> Check if the printer is using a genuine and supported Lexmark toner cartridge.</p> <p><b>Note:</b> If the cartridge is not supported, then install a supported one.</p> <p><b>b</b> Print the document.</p> <p>Is the print dark?</p>	Go to step 2.	The problem is solved.
<p><b>Step 2</b></p> <p><b>a</b> Turn off the printer, wait for about 10 seconds, and then turn on the printer.</p> <p><b>b</b> Reduce toner darkness. From the control panel, navigate to: <b>Settings &gt; Print &gt; Quality</b></p> <p><b>c</b> Print the document.</p> <p>Is the print dark?</p>	Go to step 3.	The problem is solved.
<p><b>Step 3</b></p> <p><b>a</b> Depending on your operating system, specify the paper type from the Printing Preferences or Print dialog.</p> <p><b>Notes:</b></p> <ul style="list-style-type: none"> <li>• Make sure that the setting matches the paper loaded.</li> <li>• You can also change the setting on the printer control panel.</li> </ul> <p><b>b</b> Print the document.</p> <p>Is the print dark?</p>	Go to step 4.	The problem is solved.
<p><b>Step 4</b></p> <p>Check if the paper has texture or rough finishes.</p> <p>Are you printing on textured or rough paper?</p>	Go to step 5.	Go to step 6.



Action	Yes	No
<p><b>Step 5</b></p> <p><b>a</b> Replace textured paper with plain paper.</p> <p><b>b</b> Print the document.</p> <p>Is the print dark?</p>	Go to step 6.	The problem is solved.
<p><b>Step 6</b></p> <p><b>a</b> Load paper from a fresh package.</p> <p><b>Note:</b> Paper absorbs moisture due to high humidity. Store paper in its original wrapper until you are ready to use it.</p> <p><b>b</b> Print the document.</p> <p>Is the print dark?</p>	Go to step 7.	The problem is solved.
<p><b>Step 7</b></p> <p><b>a</b> Remove, and then insert the imaging unit.</p> <p><b>Warning—Potential Damage:</b> Do not expose the imaging unit to direct light for more than 10 minutes. Extended exposure to light may cause print quality problems.</p> <p><b>Warning—Potential Damage:</b> Do not touch the photoconductor drum under the imaging unit. Doing so may affect the quality of future print jobs.</p> <p><b>b</b> Print the document.</p> <p>Is the print dark?</p>	Go to step 8.	The problem is solved.
<p><b>Step 8</b></p> <p><b>a</b> Replace the imaging unit.</p> <p><b>b</b> Print the document.</p> <p>Is the print dark?</p>	Contact <a href="#">customer support</a> .	The problem is solved.

### Fine lines are not printed correctly

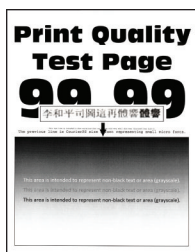

**Note:** Before solving the problem, print the Print Quality Test Pages. From the control panel, navigate to **Settings > Troubleshooting > Print Quality Test Pages**. For non-touch-screen printer models, press **OK** to navigate through the settings.

Action	Yes	No
<p><b>Step 1</b></p> <p><b>a</b> Check if the printer is using a genuine and supported Lexmark toner cartridge.</p> <p><b>Note:</b> If the cartridge is not supported, then install a supported one.</p> <p><b>b</b> Print the document.</p> <p>Are fine lines not printed correctly?</p>	Go to step 2.	The problem is solved.
<p><b>Step 2</b></p> <p><b>a</b> Adjust the print quality settings.</p> <p><b>1</b> From the control panel, navigate to: <b>Settings &gt; Print &gt; Quality &gt; Pixel Boost &gt; Fonts</b></p> <p><b>2</b> Adjust Toner Darkness to 7. From the control panel, navigate to: <b>Settings &gt; Print &gt; Quality</b></p> <p><b>b</b> Print the document.</p> <p>Are fine lines not printed correctly?</p>	Contact <a href="#">customer support</a> .	The problem is solved.

### Folded or wrinkled paper

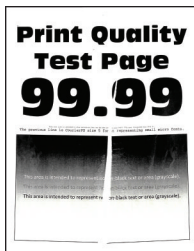



**Note:** Before solving the problem, print the Print Quality Test Pages. From the control panel, navigate to **Settings > Troubleshooting > Print Quality Test Pages**. For non-touch-screen printer models, press  to navigate through the settings.

Action	Yes	No
<p><b>Step 1</b></p> <p><b>a</b> Check if the printer is using a genuine and supported Lexmark toner cartridge.</p> <p><b>Note:</b> If the cartridge is not supported, then install a supported one.</p> <p><b>b</b> Print the document.</p> <p>Is the paper folded or wrinkled?</p>	Go to step 2.	The problem is solved.

Action	Yes	No
<p><b>Step 2</b></p> <p><b>a</b> Load paper from a fresh package.</p> <p><b>Note:</b> Paper absorbs moisture due to high humidity. Store paper in its original wrapper until you are ready to use it.</p> <p><b>b</b> Print the document.</p> <p>Is the paper folded or wrinkled?</p>	Go to step 3.	The problem is solved.
<p><b>Step 3</b></p> <p><b>a</b> Depending on your operating system, specify the paper type from the Printing Preferences or Print dialog.</p> <p><b>Notes:</b></p> <ul style="list-style-type: none"> <li>• Make sure that the setting matches the paper loaded.</li> <li>• You can also change the setting from the printer control panel.</li> </ul> <p><b>b</b> Print the document.</p> <p>Is the paper folded or wrinkled?</p>	Contact <a href="#">customer support</a> .	The problem is solved.

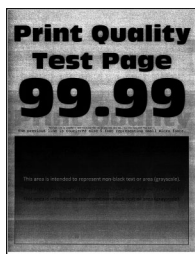
**Gray background**



**Note:** Before solving the problem, print the Print Quality Test Pages. From the control panel, navigate to **Settings > Troubleshooting > Print Quality Test Pages**. For non-touch-screen printer models, press  to navigate through the settings.

Action	Yes	No
<p><b>Step 1</b></p> <p><b>a</b> Turn off the printer, wait for 10 seconds, and then turn on the printer.</p> <p><b>b</b> Increase toner darkness.</p> <p>From the control panel, navigate to:</p> <p><b>Settings &gt; Print &gt; Quality</b></p> <p><b>c</b> Print the document.</p> <p>Does gray background appear on prints?</p>	Go to step 2.	The problem is solved.

Action	Yes	No
<p><b>Step 2</b></p> <p><b>a</b> Check if the printer is using a genuine and supported Lexmark toner cartridge.</p> <p><b>Note:</b> If the toner cartridge is not supported, then install a supported one.</p> <p><b>b</b> Print the document.</p> <p>Does gray background appear on prints?</p>	<p>Go to step 3.</p>	<p>The problem is solved.</p>
<p><b>Step 3</b></p> <p><b>a</b> Depending on your operating system, specify the paper type from the Printing Preferences or Print dialog.</p> <p><b>Notes:</b></p> <ul style="list-style-type: none"> <li>• Make sure that the setting matches the paper loaded.</li> <li>• You can also change the setting from the printer control panel.</li> </ul> <p><b>b</b> Print the document.</p> <p>Does gray background appear on prints?</p>	<p>Go to step 4.</p>	<p>The problem is solved.</p>
<p><b>Step 4</b></p> <p>Check the status of the toner cartridge, and replace if necessary.</p> <p><b>a</b> From the control panel, navigate to:</p> <p><b>Status/Supplies &gt; Supplies</b></p> <p><b>b</b> Print the document.</p> <p>Does gray background appear on prints?</p>	<p>Go to step 5.</p>	<p>The problem is solved.</p>

Action	Yes	No
<p><b>Step 5</b></p> <p><b>a</b> Remove the imaging unit.</p> <p><b>Warning—Potential Damage:</b> Do not expose the imaging unit to direct light for more than 10 minutes. Extended exposure to light may cause print quality problems.</p> <p><b>Warning—Potential Damage:</b> Do not touch the photoconductor drum under the imaging unit. Doing so may affect the quality of future print jobs.</p> <p><b>b</b> Remove any packing material that is stuck on the imaging unit.</p>  <p><b>Note:</b> Make sure to remove any obstruction between the charge roller and photoconductor drum.</p> <p><b>c</b> Insert the imaging unit.</p> <p><b>d</b> Print the document.</p> <p>Does gray background appear on prints?</p>	<p>Go to step 6.</p>	<p>The problem is solved.</p>
<p><b>Step 6</b></p> <p><b>a</b> Replace the imaging unit.</p> <p><b>b</b> Print the document.</p> <p>Does gray background appear on prints?</p>	<p>Contact <a href="#">customer support</a>.</p>	<p>The problem is solved.</p>

### Horizontal light bands



**Note:** Before solving the problem, print the Print Quality Test Pages. From the control panel, navigate to **Settings > Troubleshooting > Print Quality Test Pages**. For non-touch-screen printer models, press  to navigate through the settings.

Action	Yes	No
<p><b>a</b> Check if the printer is using a genuine and supported Lexmark toner cartridge.</p> <p><b>Note:</b> If the cartridge is not supported, then install a supported one.</p> <p><b>b</b> Print the document.</p> <p>Do horizontal light bands appear on prints?</p>	Contact <a href="#">customer support</a> .	The problem is solved.

### Incorrect margins



Action	Yes	No
<p><b>Step 1</b></p> <p><b>a</b> Adjust the paper guides to the correct position for the paper loaded.</p> <p><b>b</b> Print the document.</p> <p>Are the margins correct?</p>	The problem is solved.	Go to step 2.
<p><b>Step 2</b></p> <p><b>a</b> Depending on your operating system, specify the paper size from the Printing Preferences or Print dialog.</p> <p><b>Notes:</b></p> <ul style="list-style-type: none"> <li>• Make sure that the setting matches the paper loaded.</li> <li>• You can also change the setting from the printer control panel.</li> </ul> <p><b>b</b> Print the document.</p> <p>Are the margins correct?</p>	The problem is solved.	Contact <a href="#">customer support</a> .

### Light print

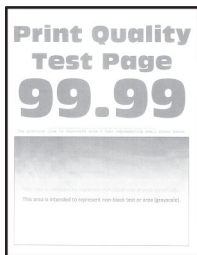

**Note:** Before solving the problem, print the Print Quality Test Pages. From the control panel, navigate to **Settings > Troubleshooting > Print Quality Test Pages**. For non-touch-screen printer models, press **OK** to navigate through the settings.

Action	Yes	No
<p><b>Step 1</b></p> <p><b>a</b> Check if the printer is using a genuine and supported Lexmark toner cartridge.</p> <p><b>Note:</b> If the cartridge is not supported, then install a supported one.</p> <p><b>b</b> Print the document.</p> <p>Is the print light?</p>	Go to step 2.	The problem is solved.
<p><b>Step 2</b></p> <p><b>a</b> Turn off the printer, wait for about 10 seconds, and then turn on the printer.</p> <p><b>b</b> Increase toner darkness. From the control panel, navigate to: <b>Settings &gt; Print &gt; Quality</b></p> <p><b>c</b> Print the document.</p> <p>Is the print light?</p>	Go to step 3.	The problem is solved.
<p><b>Step 3</b></p> <p><b>a</b> Depending on your operating system, specify the paper type from the Printing Preferences or Print dialog.</p> <p><b>Notes:</b></p> <ul style="list-style-type: none"> <li>• Make sure that the setting matches the paper loaded.</li> <li>• You can also change the setting on the printer control panel.</li> </ul> <p><b>b</b> Print the document.</p> <p>Is the print light?</p>	Go to step 4.	The problem is solved.

Action	Yes	No
<p><b>Step 4</b>                      Check the status of the toner cartridge, and replace if necessary.</p> <ul style="list-style-type: none"> <li><b>a</b> From the control panel, navigate to:  <b>Status/Supplies &gt; Supplies</b></li> <li><b>b</b> Print the document.</li> </ul> <p>Is the print light?</p>	<p>Go to step 5.</p>	<p>The problem is solved.</p>
<p><b>Step 5</b>  <b>a</b> Remove the toner cartridge, and then remove the imaging unit.</p> <p><b>Warning—Potential Damage:</b> Do not expose the imaging unit to direct light for more than 10 minutes. Extended exposure to light can cause print quality problems.</p> <p><b>Warning—Potential Damage:</b> Do not touch the photoconductor drum under the imaging unit. Doing so may affect the quality of future print jobs.</p> <p><b>b</b> Push either side of the transfer roller, located below the imaging unit, to check if it depresses and bounces back into place.</p> <p> <b>CAUTION—HOT SURFACE:</b> The inside of the printer might be hot. To reduce the risk of injury from a hot component, allow the surface to cool before touching it.</p> <p><b>c</b> If the transfer roller does not depress and bounce back into place, then remove and insert it.</p> <ul style="list-style-type: none"> <li><b>1</b> Pull up one end of the transfer roller and push it down until it <i>clicks</i> into place.</li> <li><b>2</b> If necessary, repeat the step on the other end.</li> </ul> <p><b>d</b> Firmly shake the imaging unit to redistribute the toner, and then insert it.</p> <p><b>e</b> Insert the toner cartridge.</p> <p><b>f</b> Turn off the printer, wait for 10 seconds, and then turn on the printer.</p> <p><b>g</b> Print the document.</p> <p>Is the print light?</p>	<p>Go to step 6.</p>	<p>The problem is solved.</p>
<p><b>Step 6</b>  <b>a</b> If the issue happens after installing a new maintenance kit, then check whether the transfer roller included with the kit is installed.</p> <p><b>Note:</b> If necessary, replace the transfer roller.</p> <p><b>b</b> Print the document.</p> <p>Is the print light?</p>	<p>Go to step 7.</p>	<p>The problem is solved.</p>



Action	Yes	No
<p><b>Step 7</b></p> <p>Check the status of the imaging unit. From the control panel, navigate to:</p> <p><b>Status/Supplies &gt; Supplies</b></p> <p>Is the imaging unit near End of Life?</p>	Go to step 8.	Contact <a href="#">customer support</a> .
<p><b>Step 8</b></p> <p><b>a</b> Replace the imaging unit.</p> <p><b>b</b> Print the document.</p> <p>Is the print light?</p>	Contact <a href="#">customer support</a> .	The problem is solved.

### Mottled print and dots



**Note:** Before solving the problem, print the Print Quality Test Pages. From the control panel, navigate to **Settings > Troubleshooting > Print Quality Test Pages**. For non-touch-screen printer models, press **OK** to navigate through the settings.

Action	Yes	No
<p><b>Step 1</b></p> <p><b>a</b> Check if the printer is using a genuine and supported Lexmark toner cartridge.</p> <p><b>Note:</b> If the toner cartridge is not supported, then install a supported one.</p> <p><b>b</b> Print the document.</p> <p>Is the print mottled?</p>	Go to step 2.	The problem is solved.
<p><b>Step 2</b></p> <p>Check the printer for leaked toner contamination.</p> <p>Is the printer free of leaked toner?</p>	Go to step 4.	Go to step 3.
<p><b>Step 3</b></p> <p><b>a</b> Replace the toner cartridge.</p> <p><b>b</b> Print the document.</p> <p>Is the print mottled?</p>	Go to step 4.	The problem is solved.

Action	Yes	No
<p><b>Step 4</b></p> <p>Check the status of the imaging unit. From the control panel, navigate to:</p> <p><b>Status/Supplies &gt; Supplies</b></p> <p>Is the imaging unit near end of life?</p>	Go to step 5.	Contact <a href="#">customer support</a> .
<p><b>Step 5</b></p> <p><b>a</b> Replace the imaging unit.</p> <p><b>b</b> Print the document.</p> <p>Is the print mottled?</p>	Contact <a href="#">customer support</a> .	The problem is solved.

### Paper curl



**Note:** Before solving the problem, print the Print Quality Test Pages. From the control panel, navigate to **Settings > Troubleshooting > Print Quality Test Pages**. For non-touch-screen printer models, press  to navigate through the settings.

Action	Yes	No
<p><b>Step 1</b></p> <p><b>a</b> Check if the printer is using a genuine and supported Lexmark toner cartridge.</p> <p><b>Note:</b> If the cartridge is not supported, then install a supported one.</p> <p><b>b</b> Print the document.</p> <p>Is the paper curled?</p>	Go to step 2.	The problem is solved.
<p><b>Step 2</b></p> <p><b>a</b> Adjust the guides in the tray to the correct position for the paper loaded.</p> <p><b>b</b> Print the document.</p> <p>Is the paper curled?</p>	Go to step 3.	The problem is solved.

Action	Yes	No
<p><b>Step 3</b></p> <p><b>a</b> Depending on your operating system, specify the paper size and paper type from the Printing Preferences or Print dialog.</p> <p><b>Notes:</b></p> <ul style="list-style-type: none"> <li>• Make sure that the settings match the paper loaded.</li> <li>• You can also change the settings from the printer control panel.</li> </ul> <p><b>b</b> Print the document.</p> <p>Is the paper curled?</p>	Go to step 4.	The problem is solved.
<p><b>Step 4</b></p> <p><b>a</b> Remove paper from the tray, and then turn over the paper.</p> <p><b>b</b> Print the document.</p> <p>Is the paper curled?</p>	Go to step 5.	The problem is solved.
<p><b>Step 5</b></p> <p><b>a</b> Load paper from a fresh package.</p> <p><b>Note:</b> Paper absorbs moisture due to high humidity. Store paper in its original wrapper until you are ready to use it.</p> <p><b>b</b> Print the document.</p> <p>Is the paper curled?</p>	Go to step 6.	The problem is solved.
<p><b>Step 6</b></p> <p><b>a</b> Check if the paper loaded is supported.</p> <p><b>Note:</b> If paper is not supported, then load a supported paper.</p> <p><b>b</b> Print the document.</p> <p>Is the paper curled?</p>	Contact <a href="#">customer support</a> .	The problem is solved.

### Print crooked or skewed



**Note:** Before solving the problem, print the Print Quality Test Pages. From the control panel, navigate to **Settings > Troubleshooting > Print Quality Test Pages**. For non-touch-screen printer models, press  to navigate through the settings.

Action	Yes	No
<p><b>Step 1</b></p> <p><b>a</b> Adjust the guides in the tray to the correct position for the paper loaded.</p> <p><b>b</b> Print the document.</p> <p>Is the print crooked or skewed?</p>	Go to step 2.	The problem is solved.
<p><b>Step 2</b></p> <p><b>a</b> Check if the paper loaded is supported.</p> <p><b>Note:</b> If paper is not supported, then load a supported paper.</p> <p><b>b</b> Print the document.</p> <p>Is the print crooked or skewed?</p>	Go to step 3.	The problem is solved.
<p><b>Step 3</b></p> <p><b>a</b> Check the pick tire in the tray for signs of damage and contamination, and replace if necessary.</p> <p><b>b</b> Print the document.</p> <p>Is the print crooked or skewed?</p>	Contact <a href="#">customer support</a> .	The problem is solved.

**Repeating defects**





**Note:** Before solving the problem, print the Print Quality Test Pages. From the control panel, navigate to **Settings > Troubleshooting > Print Quality Test Pages**. For non-touch-screen printer models, press  to navigate through the settings.

Action	Yes	No
<p><b>Step 1</b></p> <p>Using the Print Quality Test Pages, check if the distance between the repeating defects is equal to any of the following:</p> <ul style="list-style-type: none"> <li>• 97 mm (3.82 in.)</li> <li>• 47 mm (1.85 in.)</li> <li>• 38 mm (1.5 in.)</li> </ul> <p>Does the distance between the repeating defects match any of the measurements?</p>	Go to step 2.	Take note of the distance, and then contact <a href="#">customer support</a> .

Action	Yes	No
<p><b>Step 2</b></p> <p><b>a</b> Replace the imaging unit.</p> <p><b>b</b> Print the document.</p> <p>Do the repeating defects appear?</p>	<p>Contact <a href="#">customer support</a>.</p>	<p>The problem is solved.</p>

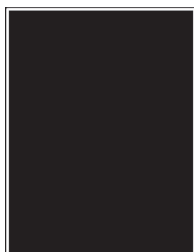
### Solid black pages



**Note:** Before solving the problem, print the Print Quality Test Pages. From the control panel, navigate to **Settings > Troubleshooting > Print Quality Test Pages**. For non-touch-screen printer models, press  to navigate through the settings.

Action	Yes	No
<p><b>Step 1</b></p> <p><b>a</b> Check if the printer is using a genuine and supported Lexmark toner cartridge.</p> <p><b>Note:</b> If the toner cartridge is not supported, then install a supported one.</p> <p><b>b</b> Print the document.</p> <p>Is the printer printing solid black pages?</p>	<p>Go to step 2.</p>	<p>The problem is solved.</p>
<p><b>Step 2</b></p> <p><b>a</b> Remove, and then insert the imaging unit.</p> <p><b>Warning—Potential Damage:</b> Do not expose the imaging unit to direct light for more than 10 minutes. Extended exposure to light may cause print quality problems.</p> <p><b>Warning—Potential Damage:</b> Do not touch the photoconductor drum under the imaging unit. Doing so may affect the quality of future print jobs.</p> <p><b>b</b> Print the document.</p> <p>Is the printer printing solid black pages?</p>	<p>Go to step 3.</p>	<p>The problem is solved.</p>

Action	Yes	No
<p><b>Step 3</b></p> <p><b>a</b> Remove the imaging unit.</p> <p><b>Warning—Potential Damage:</b> Do not expose the imaging unit to direct light for more than 10 minutes. Extended exposure to light may cause print quality problems.</p> <p><b>Warning—Potential Damage:</b> Do not touch the photoconductor drum under the imaging unit. Doing so may affect the quality of future print jobs.</p> <p><b>b</b> Remove any packing material that is stuck on the imaging unit.</p>  <p><b>Note:</b> Make sure to remove any obstruction between the charge roller and photoconductor drum.</p> <p><b>c</b> Insert the imaging unit.</p> <p><b>d</b> Print the document.</p> <p>Is the printer printing solid black pages?</p>	<p>Go to step 4.</p>	<p>The problem is solved.</p>
<p><b>Step 4</b></p> <p>Check the imaging unit for signs of damage.</p> <p>Is the imaging unit free from damage?</p>	<p>Contact <a href="#">customer support</a>.</p>	<p>Go to step 5.</p>
<p><b>Step 5</b></p> <p><b>a</b> Replace the imaging unit.</p> <p><b>b</b> Print the document.</p> <p>Is the printer printing solid black pages?</p>	<p>Contact <a href="#">customer support</a>.</p>	<p>The problem is solved.</p>

**Text or images cut off**



**Note:** Before solving the problem, print the Print Quality Test Pages. From the control panel, navigate to **Settings > Troubleshooting > Print Quality Test Pages**. For non-touch-screen printer models, press  to navigate through the settings.

Action	Yes	No
<p><b>Step 1</b></p> <p><b>a</b> Check if the printer is using a genuine and supported Lexmark toner cartridge.</p> <p><b>Note:</b> If the toner cartridge is not supported, then install a supported one.</p> <p><b>b</b> Print the document.</p> <p>Are text or images cut off?</p>	<p>Go to step 2.</p>	<p>The problem is solved.</p>
<p><b>Step 2</b></p> <p><b>a</b> Remove, and then insert the imaging unit.</p> <p><b>Warning—Potential Damage:</b> Do not expose the imaging unit to direct light for more than 10 minutes. Extended exposure to light may cause print quality problems.</p> <p><b>Warning—Potential Damage:</b> Do not touch the photoconductor drum under the imaging unit. Doing so may affect the quality of future print jobs.</p> <p><b>b</b> Print the document.</p> <p>Are text or images cut off?</p>	<p>Go to step 3.</p>	<p>The problem is solved.</p>
<p><b>Step 3</b></p> <p><b>a</b> Remove the imaging unit.</p> <p><b>Warning—Potential Damage:</b> Do not expose the imaging unit to direct light for more than 10 minutes. Extended exposure to light may cause print quality problems.</p> <p><b>Warning—Potential Damage:</b> Do not touch the photoconductor drum under the imaging unit. Doing so may affect the quality of future print jobs.</p> <p><b>b</b> Remove any packing material that is stuck on the imaging unit.</p> <div data-bbox="402 1373 776 1514" data-label="Image"> </div> <p><b>Note:</b> Make sure to remove any obstruction between the charge roller and photoconductor drum.</p> <p><b>c</b> Insert the imaging unit.</p> <p><b>d</b> Print the document.</p> <p>Are text or images cut off?</p>	<p>Go to step 4.</p>	<p>The problem is solved.</p>
<p><b>Step 4</b></p> <p><b>a</b> Replace the imaging unit.</p> <p><b>b</b> Print the document.</p> <p>Are text or images cut off?</p>	<p>Contact <a href="#">customer support</a>.</p>	<p>The problem is solved.</p>

### Toner easily rubs off



**Note:** Before solving the problem, print the Print Quality Test Pages. From the control panel, navigate to **Settings > Troubleshooting > Print Quality Test Pages**. For non-touch-screen printer models, press **OK** to navigate through the settings.

Action	Yes	No
<p><b>Step 1</b></p> <p><b>a</b> Check if the printer is using a genuine and supported Lexmark toner cartridge.</p> <p><b>Note:</b> If the toner cartridge is not supported, then install a supported one.</p> <p><b>b</b> Print the document.</p> <p>Does the toner easily rub off?</p>	<p>Go to step 2.</p>	<p>The problem is solved.</p>
<p><b>Step 2</b></p> <p><b>a</b> Depending on your operating system, specify the paper type from the Printing Preferences or Print dialog.</p> <p><b>Notes:</b></p> <ul style="list-style-type: none"> <li>• Make sure that the setting matches the paper loaded.</li> <li>• You can also change the setting on the printer control panel.</li> </ul> <p><b>b</b> Print the document.</p> <p>Does the toner easily rub off?</p>	<p>Contact <a href="#">customer support</a>.</p>	<p>The problem is solved.</p>

### Vertical dark bands

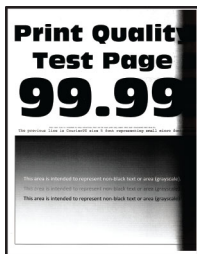



**Note:** Before solving the problem, print the Print Quality Test Pages. From the control panel, navigate to **Settings > Troubleshooting > Print Quality Test Pages**. For non-touch-screen printer models, press **OK** to navigate through the settings.

Action	Yes	No
<p><b>Step 1</b></p> <p><b>a</b> Check if the printer is using a genuine and supported Lexmark toner cartridge.</p> <p><b>Note:</b> If the toner cartridge is not supported, then install a supported one.</p> <p><b>b</b> Print the document.</p> <p>Do vertical dark bands appear on prints?</p>	Go to step 2.	The problem is solved.
<p><b>Step 2</b></p> <p><b>a</b> Remove the toner cartridge, and then remove the imaging unit.</p> <p><b>Warning—Potential Damage:</b> Do not expose the imaging unit to direct light for more than 10 minutes. Extended exposure to light may cause print quality problems.</p> <p><b>Warning—Potential Damage:</b> Do not touch the photoconductor drum under the imaging unit. Doing so may affect the quality of future print jobs.</p> <p><b>b</b> Insert the imaging unit, and then insert the cartridge.</p> <p><b>c</b> Print the document.</p> <p>Do vertical dark bands appear on prints?</p>	Go to step 3.	The problem is solved.
<p><b>Step 3</b></p> <p><b>a</b> Remove the imaging unit.</p> <p><b>Warning—Potential Damage:</b> Do not expose the imaging unit to direct light for more than 10 minutes. Extended exposure to light may cause print quality problems.</p> <p><b>Warning—Potential Damage:</b> Do not touch the photoconductor drum under the imaging unit. Doing so may affect the quality of future print jobs.</p> <p><b>b</b> Remove any packing material that is stuck on the imaging unit.</p>  <p><b>Note:</b> Make sure to remove any obstruction between the charge roller and photoconductor drum.</p> <p><b>c</b> Insert the imaging unit.</p> <p><b>d</b> Print the document.</p> <p>Do vertical dark bands appear on prints?</p>	Go to step 4.	The problem is solved.

Action	Yes	No
<p><b>Step 4</b></p> <p><b>a</b> Check if a bright light enters the right side of the printer, and move the printer if necessary.</p> <p><b>b</b> Print the document.</p> <p>Do vertical dark bands appear on prints?</p>	<p>Contact <a href="#">customer support</a>.</p>	<p>The problem is solved.</p>

### Vertical dark lines or streaks



Action	Yes	No
<p><b>Step 1</b></p> <p><b>a</b> From the control panel, navigate to: <b>Settings &gt; Troubleshooting &gt; Cleaning the scanner</b></p> <p><b>b</b> Print the document.</p> <p>Do vertical dark lines or streaks appear on prints?</p>	<p>Go to step 3.</p>	<p>Go to step 2.</p>
<p><b>Step 2</b></p> <p><b>a</b> Using a damp, soft, lint-free cloth, clean the scanner. For more information, see <a href="#">“Cleaning the scanner” on page 145</a>.</p> <p><b>b</b> Copy the document using the ADF.</p> <p>Do vertical dark lines or streaks appear on prints?</p>	<p>Contact <a href="#">customer support</a>.</p>	<p>The problem is solved.</p>
<p><b>Step 3</b></p> <p><b>a</b> Check if the printer is using a genuine and supported Lexmark toner cartridge.</p> <p><b>Note:</b> If the toner cartridge is not supported, then install a supported one.</p> <p><b>b</b> Print the document.</p> <p>Do vertical dark lines or streaks appear on prints?</p>	<p>Go to step 4.</p>	<p>The problem is solved.</p>

Action	Yes	No
<p><b>Step 4</b></p> <p><b>a</b> Remove, and then insert the imaging unit.</p> <p><b>Warning—Potential Damage:</b> Do not expose the imaging unit to direct light for more than 10 minutes. Extended exposure to light can cause print quality problems.</p> <p><b>Warning—Potential Damage:</b> Do not touch the photoconductor drum under the imaging unit. Doing so may affect the quality of future print jobs.</p> <p><b>b</b> Print the document.</p> <p>Do vertical dark lines or streaks appear on prints?</p>	Go to step 5.	The problem is solved.
<p><b>Step 5</b></p> <p><b>a</b> Replace the imaging unit.</p> <p><b>b</b> Print the document.</p> <p>Do vertical dark lines or streaks appear on prints?</p>	Contact <a href="#">customer support</a> .	The problem is solved.

**Vertical dark streaks with print missing**

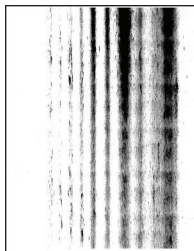

**Note:** Before solving the problem, print the Print Quality Test Pages. From the control panel, navigate to **Settings > Troubleshooting > Print Quality Test Pages**. For non-touch-screen printer models, press **OK** to navigate through the settings.

Action	Yes	No
<p><b>Step 1</b></p> <p><b>a</b> Remove the imaging unit.</p> <p><b>Warning—Potential Damage:</b> Do not expose the imaging unit to direct light for more than 10 minutes. Extended exposure to light may cause print quality problems.</p> <p><b>Warning—Potential Damage:</b> Do not touch the photoconductor drum under the imaging unit. Doing so may affect the quality of future print jobs.</p> <p><b>b</b> Remove any packing material that is stuck on the imaging unit.</p>  <p><b>Note:</b> Make sure to remove any obstruction between the charge roller and photoconductor drum.</p> <p><b>c</b> Insert the imaging unit.</p> <p><b>d</b> Print the document.</p> <p>Do vertical dark streaks with missing images appear on prints?</p>	<p>Go to step 2.</p>	<p>The problem is solved.</p>
<p><b>Step 2</b></p> <p><b>a</b> Check if the printer is using a genuine and supported Lexmark toner cartridge.</p> <p><b>Note:</b> If the toner cartridge is not supported, then install a supported one.</p> <p><b>b</b> Print the document.</p> <p>Do vertical dark streaks with missing images appear on prints?</p>	<p>Contact <a href="#">customer support</a>.</p>	<p>The problem is solved.</p>

### Vertical light bands



**Note:** Before solving the problem, print the Print Quality Test Pages. From the control panel, navigate to **Settings > Troubleshooting > Print Quality Test Pages**. For non-touch-screen printer models, press  to navigate through the settings.

Action	Yes	No
<p><b>a</b> Check if the printer is using a genuine and supported Lexmark toner cartridge.</p> <p><b>Note:</b> If the cartridge is not supported, then install a supported one.</p> <p><b>b</b> Print the document.</p> <p>Do vertical light bands appear on prints?</p>	Contact <a href="#">customer support</a> .	The problem is solved.

### Vertical white lines



**Note:** Before solving the problem, print the Print Quality Test Pages. From the control panel, navigate to **Settings > Troubleshooting > Print Quality Test Pages**. For non-touch-screen printer models, press  to navigate through the settings.

Action	Yes	No
<p><b>Step 1</b></p> <p><b>a</b> Check if the printer is using a genuine and supported Lexmark toner cartridge.</p> <p><b>Note:</b> If the cartridge is not supported, then install a supported one.</p> <p><b>b</b> Print the document.</p> <p>Do vertical white lines appear on prints?</p>	Go to step 2.	The problem is solved.
<p><b>Step 2</b></p> <p><b>a</b> Depending on your operating system, specify the paper type from the Printing Preferences or Print dialog.</p> <p><b>Notes:</b></p> <ul style="list-style-type: none"> <li>• Make sure that the setting matches the paper loaded.</li> <li>• You can also change the setting on the printer control panel.</li> </ul> <p><b>b</b> Print the document.</p> <p>Do vertical white lines appear on prints?</p>	Contact <a href="#">customer support</a> .	The problem is solved.

## Confidential and other held documents do not print

Action	Yes	No
<p><b>Step 1</b></p> <p><b>a</b> From the control panel, check if the documents appear in the Held Jobs list.</p> <p><b>Note:</b> If the documents are not listed, then print the documents using the Print and Hold options.</p> <p><b>b</b> Print the documents.</p> <p>Are the documents printed?</p>	The problem is solved.	Go to step 2.
<p><b>Step 2</b></p> <p>The print job may contain a formatting error or invalid data.</p> <ul style="list-style-type: none"> <li>• Delete the print job, and then send it again.</li> <li>• For PDF files, generate a new file, and then print the documents.</li> </ul> <p>Are the documents printed?</p>	The problem is solved.	Go to step 3.
<p><b>Step 3</b></p> <p>If you are printing from the Internet, then the printer may be reading the multiple job titles as duplicates.</p> <p><b>For Windows users</b></p> <p><b>a</b> Open the Printing Preferences dialog.</p> <p><b>b</b> From the Print and Hold section, select <b>Keep duplicate documents</b>.</p> <p><b>c</b> Enter a PIN.</p> <p><b>d</b> Resend the print job.</p> <p><b>For Macintosh users</b></p> <p><b>a</b> Save and name each job differently.</p> <p><b>b</b> Send the job individually.</p> <p>Are the documents printed?</p>	The problem is solved.	Go to step 4.
<p><b>Step 4</b></p> <p><b>a</b> Delete some held jobs to free up printer memory.</p> <p><b>b</b> Resend the print job.</p> <p>Are the documents printed?</p>	The problem is solved.	Go to step 5.
<p><b>Step 5</b></p> <p><b>a</b> Add printer memory.</p> <p><b>b</b> Resend the print job.</p> <p>Are the documents printed?</p>	The problem is solved.	Contact <a href="#">customer support</a> .

## Slow printing

Action	Yes	No
<p><b>Step 1</b></p> <p><b>a</b> Make sure that the printer is not in Eco-Mode and Quiet Mode.</p> <p><b>b</b> Print the document.</p> <p>Is the printer still printing slow?</p>	Go to step 2.	The problem is solved.
<p><b>Step 2</b></p> <p><b>a</b> Depending on your operating system, specify the paper type from the Printing Preferences or Print dialog.</p> <p><b>Notes:</b></p> <ul style="list-style-type: none"> <li>• Make sure that the setting matches the paper loaded in the tray.</li> <li>• You can also change the setting from the Paper menu on the printer control panel.</li> </ul> <p><b>b</b> Print the document.</p> <p>Is the printer still printing slow?</p>	Go to step 3.	The problem is solved.
<p><b>Step 3</b></p> <p><b>a</b> Reduce the number of pages to print.</p> <p><b>b</b> Print the document.</p> <p>Is the printer still printing slow?</p>	Go to step 4.	The problem is solved.
<p><b>Step 4</b></p> <p><b>a</b> Connect the printer cable securely to the printer and the computer, print server, option, or other network device.</p> <p><b>b</b> Print the document.</p> <p>Is the printer still printing slow?</p>	Go to step 5.	The problem is solved.
<p><b>Step 5</b></p> <p><b>a</b> From the Quality menu on the control panel, set Print Resolution to 600 dpi.</p> <p><b>b</b> Print the document.</p> <p>Is the printer still printing slow?</p>	Go to step 6.	The problem is solved.

Action	Yes	No
<p><b>Step 6</b></p> <p><b>a</b> Make sure that the printer is not overheating.</p> <p><b>Notes:</b></p> <ul style="list-style-type: none"> <li>• Allow the printer to cool down after a very long print job.</li> <li>• Observe the recommended ambient temperature for the printer. For more information, see <a href="#">“Selecting a location for the printer” on page 11.</a></li> </ul> <p><b>b</b> Print the document.</p> <p>Is the printer still printing slow?</p>	Go to step 7.	The problem is solved.
<p><b>Step 7</b></p> <p><b>a</b> Add more printer memory.</p> <p><b>b</b> Print the document.</p> <p>Is the printer still printing slow?</p>	Contact <a href="#">customer support</a> .	The problem is solved.

### Print jobs do not print

Action	Yes	No
<p><b>Step 1</b></p> <p><b>a</b> From the document you are trying to print, open the Print dialog, and then check if you have selected the correct printer.</p> <p><b>b</b> Print the document.</p> <p>Is the document printed?</p>	The problem is solved.	Go to step 2.
<p><b>Step 2</b></p> <p><b>a</b> Check if the printer is on.</p> <p><b>b</b> Resolve any error messages that appear on the display.</p> <p><b>c</b> Print the document.</p> <p>Is the document printed?</p>	The problem is solved.	Go to step 3.
<p><b>Step 3</b></p> <p><b>a</b> Check if the ports are working and if the cables are securely connected to the computer and the printer. For more information, see the setup documentation that came with the printer.</p> <p><b>b</b> Print the document.</p> <p>Is the document printed?</p>	The problem is solved.	Go to step 4.



Action	Yes	No
<p><b>Step 4</b></p> <p><b>a</b> Turn off the printer, wait for about 10 seconds, and then turn on the printer.</p> <p><b>b</b> Print the document.</p> <p>Is the document printed?</p>	The problem is solved.	Go to step 5.
<p><b>Step 5</b></p> <p><b>a</b> Remove, and then reinstall the print driver.</p> <p><b>b</b> Print the document.</p> <p>Is the document printed?</p>	The problem is solved.	Contact <a href="#">customer support</a> .

## Adjusting toner darkness

- From the control panel, navigate to:  
**Settings > Print > Quality > Toner Darkness**

For non-touch-screen printer models, press  to navigate through the settings.

- Adjust the setting.
- Apply the changes.

## The printer is not responding

Action	Yes	No
<p><b>Step 1</b></p> <p>Check if the power cord is connected to the electrical outlet.</p> <p> <b>CAUTION—POTENTIAL INJURY:</b> To avoid the risk of fire or electrical shock, connect the power cord to an appropriately rated and properly grounded electrical outlet that is near the product and easily accessible.</p> <p>Is the printer responding?</p>	The problem is solved.	Go to step 2.
<p><b>Step 2</b></p> <p>Check if the electrical outlet is turned off by a switch or breaker.</p> <p>Is the electrical outlet turned off by a switch or breaker?</p>	Turn on the switch or reset the breaker.	Go to step 3.
<p><b>Step 3</b></p> <p>Check if the printer is on.</p> <p>Is the printer on?</p>	Go to step 4.	Turn on the printer.

Action	Yes	No
<p><b>Step 4</b> Check if the printer is in Sleep or Hibernate mode.</p> <p>Is the printer in Sleep or Hibernate mode?</p>	Press the power button to wake the printer.	Go to step 5.
<p><b>Step 5</b> Check if the cables connecting the printer and the computer are inserted to the correct ports.</p> <p>Are the cables inserted to the correct ports?</p>	Go to step 6.	Insert the cables to the correct ports.
<p><b>Step 6</b> Turn off the printer, install the hardware options, and then turn on the printer. For more information, see the documentation that came with the option.</p> <p>Is the printer responding?</p>	The problem is solved.	Go to step 7.
<p><b>Step 7</b> Install the correct print driver.</p> <p>Is the printer responding?</p>	The problem is solved.	Go to step 8.
<p><b>Step 8</b> Turn off the printer, wait for about 10 seconds, and then turn on the printer.</p> <p>Is the printer responding?</p>	The problem is solved.	Contact <a href="#">customer support</a> .

### Job prints from the wrong tray or on the wrong paper

Action	Yes	No
<p><b>Step 1</b></p> <p><b>a</b> Check if you are printing on the correct paper. <b>b</b> Print the document.</p> <p>Is the document printed on the correct paper?</p>	Go to step 2.	Load the correct paper size and paper type.

Action	Yes	No
<p><b>Step 2</b></p> <p><b>a</b> Depending on your operating system, specify the paper size and paper type from the Printing Preferences or Print dialog.</p> <p><b>Note:</b> You can also change the settings on the printer control panel. Navigate to:</p> <p><b>Settings &gt; Paper &gt; Tray Configuration &gt; Paper Size/Type</b></p> <p>For non-touch-screen printer models, press  to navigate through the settings.</p> <p><b>b</b> Make sure that the settings match the paper loaded.</p> <p><b>c</b> Print the document.</p> <p>Is the document printed on the correct paper?</p>	<p>The problem is solved.</p>	<p>Go to step 3.</p>
<p><b>Step 3</b></p> <p><b>a</b> Check if the trays are linked.</p> <p>For more information, see <a href="#">“Linking trays” on page 29</a>.</p> <p><b>b</b> Print the document.</p> <p>Is the document printed from the correct tray?</p>	<p>The problem is solved.</p>	<p>Contact <a href="#">customer support</a>.</p>

## Faxing problems

### Cannot send or receive faxes

Action	Yes	No
<p><b>Step 1</b></p> <p>Resolve any error messages that appear on the display.</p> <p>Can you send or receive a fax?</p>	<p>The problem is solved.</p>	<p>Go to step 2.</p>
<p><b>Step 2</b></p> <p>Make sure that the cable connections for the following equipment are secure:</p> <ul style="list-style-type: none"> <li>• Telephone</li> <li>• Handset</li> <li>• Answering machine</li> </ul> <p>Can you send or receive a fax?</p>	<p>The problem is solved.</p>	<p>Go to step 3.</p>

Action	Yes	No
<p><b>Step 3</b></p> <p>Check for a dial tone.</p> <ul style="list-style-type: none"> <li>• Call the fax number to check if it is working properly.</li> <li>• If you are using the On Hook Dial feature, then turn up the volume to check if you hear a dial tone.</li> </ul> <p>Can you hear a dial tone?</p>	<p>Go to step 5.</p>	<p>Go to step 4.</p>
<p><b>Step 4</b></p> <p>Check the telephone wall jack.</p> <ol style="list-style-type: none"> <li>a Connect the analog telephone directly to the wall jack.</li> <li>b Listen for a dial tone.</li> <li>c If you do not hear a dial tone, then use a different telephone cable.</li> <li>d If you still do not hear a dial tone, then connect the analog telephone to a different wall jack.</li> <li>e If you hear a dial tone, then connect the printer to that wall jack.</li> </ol> <p>Can you send or receive a fax?</p>	<p>The problem is solved.</p>	<p>Go to step 5.</p>
<p><b>Step 5</b></p> <p>Check if the printer is connected to an analog phone service or to the correct digital connector.</p> <ul style="list-style-type: none"> <li>• If you are using an Integrated Services for Digital Network (ISDN) telephone service, then connect to an analog telephone port of an ISDN terminal adapter. For more information, contact your ISDN provider.</li> <li>• If you are using DSL, then connect to a DSL filter or router that supports analog use. For more information, contact your DSL provider.</li> <li>• If you are using a private branch exchange (PBX) telephone service, then make sure that you are connecting to an analog connection on the PBX. If none exists, then consider installing an analog telephone line for the fax machine.</li> </ul> <p>Can you send or receive a fax?</p>	<p>The problem is solved.</p>	<p>Go to step 6.</p>
<p><b>Step 6</b></p> <p>Temporarily disconnect other equipment and disable other telephone services.</p> <ol style="list-style-type: none"> <li>a Disconnect other equipment (such as answering machines, computers, modems, or telephone line splitters) between the printer and the telephone line.</li> <li>b Disable call waiting and voice mail. For more information, contact your telephone company.</li> </ol> <p>Can you send or receive a fax?</p>	<p>The problem is solved.</p>	<p>Go to step 7.</p>

Action	Yes	No
<p><b>Step 7</b> Scan the original document one page at a time.</p> <ul style="list-style-type: none"> <li><b>a</b> Dial the fax number.</li> <li><b>b</b> Scan the document.</li> </ul> <p>Can you send or receive a fax?</p>	The problem is solved.	Contact <a href="#">customer support</a> .

### Can receive but not send faxes

Action	Yes	No
<p><b>Step 1</b> Load the original document properly into the ADF tray or on the scanner glass.</p> <p>Can you send faxes?</p>	The problem is solved.	Go to step 2.
<p><b>Step 2</b> Set up the shortcut number properly.</p> <ul style="list-style-type: none"> <li>• Check if the shortcut number is set for the telephone number that you want to dial.</li> <li>• Dial the telephone number manually.</li> </ul> <p>Can you send faxes?</p>	The problem is solved.	Contact <a href="#">customer support</a> .

### Can send but not receive faxes

Action	Yes	No
<p><b>Step 1</b> Make sure that the tray or multipurpose feeder is not empty.</p> <p>Can you receive faxes?</p>	The problem is solved.	Go to step 2.
<p><b>Step 2</b> Check the ring count delay settings.</p> <ul style="list-style-type: none"> <li><b>a</b> From the home screen, touch <b>Settings &gt; Fax &gt; Analog Fax Setup &gt; Fax Receive Settings &gt; Rings to Answer</b>.</li> <li><b>b</b> If necessary, configure the setting.</li> </ul> <p>Can you receive faxes?</p>	The problem is solved.	Go to step 3.
<p><b>Step 3</b> Replace the toner cartridge. For more information, see the instruction sheet that came with the supply.</p> <p>Can you receive faxes?</p>	The problem is solved.	Contact <a href="#">customer support</a> .

## Poor fax print quality

Action	Yes	No
<p><b>Step 1</b> Enhance the print quality.</p> <p><b>a</b> From the home screen, touch <b>Settings &gt; Print &gt; Quality</b>.</p> <p><b>b</b> Adjust the settings.</p> <p>Is the fax print quality satisfactory?</p>	The problem is solved.	Go to step 2.
<p><b>Step 2</b> Decrease the incoming fax transmission speed.</p> <p><b>a</b> From the home screen, touch <b>Settings &gt; Fax &gt; Analog Fax Setup &gt; Fax Receive Settings &gt; Admin Controls &gt; Max Speed</b>.</p> <p><b>b</b> Select a lower transmission speed.</p> <p>Is the fax print quality satisfactory?</p>	The problem is solved.	Go to step 3.
<p><b>Step 3</b> Replace the toner cartridge.</p> <p>For more information, see the instruction sheet that came with the supply.</p> <p>Is the fax print quality satisfactory?</p>	The problem is solved.	Contact <a href="#">customer support</a> .

## Scanning problems

### Cannot scan from a computer

Action	Yes	No
<p><b>Step 1</b></p> <p><b>a</b> Turn off the printer, wait for about 10 seconds, and then turn it back on.</p> <p><b>b</b> Resend the scan job.</p> <p>Can you send the scan job?</p>	The problem is solved.	Go to step 2.
<p><b>Step 2</b></p> <p><b>a</b> Make sure that the cables between the printer and the print server are secure.</p> <p>For more information, see the setup documentation that came with the printer.</p> <p><b>b</b> Resend the scan job.</p> <p>Can you send the scan job?</p>	The problem is solved.	Contact <a href="#">customer support</a> .

### Partial copies of document or photo

Action	Yes	No
<p><b>Step 1</b></p> <p><b>a</b> Make sure that the document or photo is loaded facedown on the upper left corner of the scanner glass.</p> <p><b>b</b> Copy the document or photo.</p> <p>Is the document or photo copied correctly?</p>	The problem is solved.	Go to step 2.
<p><b>Step 2</b></p> <p><b>a</b> Match the paper size setting and the paper loaded in the tray.</p> <p><b>b</b> Copy the document or photo.</p> <p>Is the document or photo copied correctly?</p>	The problem is solved.	Contact <a href="#">customer support</a> .

### Poor copy quality

Action	Yes	No
<p><b>Step 1</b></p> <p><b>a</b> Clean the scanner glass and the ADF glass with a damp, soft, lint-free cloth. If your printer has a second ADF glass inside the ADF, then also clean that glass.</p> <p>For more information, see <a href="#">“Cleaning the scanner” on page 145</a>.</p> <p><b>b</b> Make sure that the document or photo is loaded facedown on the upper left corner of the scanner glass.</p> <p><b>c</b> Copy the document or photo.</p> <p>Is the copy quality satisfactory?</p>	The problem is solved.	Go to step 2.
<p><b>Step 2</b></p> <p><b>a</b> Check the quality of the original document or photo.</p> <p><b>b</b> Adjust the scan quality settings.</p> <p><b>c</b> Copy the document or photo.</p> <p>Is the copy quality satisfactory?</p>	The problem is solved.	Contact <a href="#">customer support</a> .

### Vertical dark streaks on output when scanning from the ADF

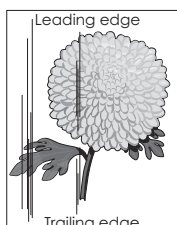
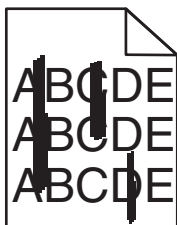

Action	Yes	No
<p><b>Step 1</b></p> <p><b>a</b> Open the scanner cover.</p> <p><b>b</b> Using a damp, soft, lint-free cloth, wipe the ADF glass and the white underside of the ADF cover.</p> <p><b>c</b> Close the scanner cover.</p> <p>Do vertical streaks still appear on scanned documents?</p>	Go to step 2.	The problem is solved.
<p><b>Step 2</b></p> <p><b>a</b> Open door C.</p> <p><b>b</b> Using a damp, soft, lint-free cloth, wipe the ADF glass and the white underside of the ADF cover.</p> <p><b>c</b> Close the door.</p> <p>Do vertical streaks still appear on scanned documents?</p>	Contact <a href="#">customer support</a> .	The problem is solved.

### Scan job was not successful

Action	Yes	No
<p><b>Step 1</b></p> <p>Check the cable connections.</p> <p><b>a</b> Make sure that the Ethernet or USB cable is securely connected to the computer and the printer.</p> <p><b>b</b> Resend the scan job.</p> <p>Is the scan job successful?</p>	The problem is solved.	Go to step 2.
<p><b>Step 2</b></p> <p>Check the file you want to scan.</p> <p><b>a</b> Make sure that the file name is not already used in the destination folder.</p> <p><b>b</b> Make sure that the document or photo you want to scan is not open in another application.</p> <p><b>c</b> Resend the scan job.</p> <p>Is the scan job successful?</p>	The problem is solved.	Go to step 3.
<p><b>Step 3</b></p> <p><b>a</b> Make sure that the <b>Append time stamp</b> or the <b>Overwrite existing file</b> check box is selected in the destination configuration settings.</p> <p><b>b</b> Resend the scan job.</p> <p>Is the scan job successful?</p>	The problem is solved.	Contact <a href="#">customer support</a> .



### Scanner does not close

Action	Yes	No
Remove obstructions that keep the scanner unit open.  Did the scanner unit close correctly?	The problem is solved.	Contact <a href="#">customer support</a> .

### Scanning takes too long or freezes the computer

Action	Yes	No
Close all applications that are interfering with the scan.  Does scanning take too long or freeze the computer?	Contact <a href="#">customer support</a> .	The problem is solved.

### Scanner does not respond

Action	Yes	No
<p><b>Step 1</b></p> <p><b>a</b> Check if the power cord is connected properly to the printer and the electrical outlet.</p> <p> <b>CAUTION—POTENTIAL INJURY:</b> To avoid the risk of fire or electrical shock, connect the power cord to an appropriately rated and properly grounded electrical outlet that is near the product and easily accessible.</p> <p><b>b</b> Copy or scan the document.</p> <p>Is the scanner responding?</p>	The problem is solved.	Go to step 2.
<p><b>Step 2</b></p> <p><b>a</b> Check if the printer is turned on.</p> <p><b>b</b> Resolve any error messages that appear on the display.</p> <p><b>c</b> Copy or scan the document.</p> <p>Is the scanner responding?</p>	The problem is solved.	Go to step 3.
<p><b>Step 3</b></p> <p><b>a</b> Turn off the printer, wait for about 10 seconds, and then turn the printer on.</p> <p><b>b</b> Copy or scan the document.</p> <p>Is the scanner responding?</p>	The problem is solved.	Contact <a href="#">customer support</a> .

## Adjusting scanner registration

- 1 From the control panel, navigate to:  
**Settings > Maintenance > Configuration Menu > Scanner Configuration > Scanner Manual Registration**
- 2 From the Print Quick Test menu, touch **Start**.
- 3 Place the Print Quick Test page on the scanner glass, and then touch **Flatbed Registration**.
- 4 From the Copy Quick Test menu, touch **Start**.
- 5 Compare the Copy Quick Test page with the original document.  
**Note:** If the margins of the test page are different from the original document, then adjust Left Margin and Top Margin.
- 6 Repeat [step 4](#) and [step 5](#) until the margins of the Copy Quick Test page closely match the original document.

## Adjusting ADF registration

- 1 From the control panel, navigate to:  
**Settings > Maintenance > Configuration Menu > Scanner Configuration > Scanner Manual Registration**
- 2 From the Print Quick Test menu, touch **Start**.
- 3 Place the Print Quick Test page on the ADF tray.
- 4 Touch **Front ADF Registration** or **Rear ADF Registration**.  
**Notes:**
  - To align Front ADF Registration, place the test page faceup, short edge first into the ADF.
  - To align Rear ADF Registration, place the test page facedown, short edge first into the ADF.
- 5 From the Copy Quick Test menu, touch **Start**.
- 6 Compare the Copy Quick Test page with the original document.  
**Note:** If the margins of the test page are different from the original document, then adjust Horizontal Adjust and Top Margin.
- 7 Repeat [step 5](#) and [step 6](#) until the margins of the Copy Quick Test page closely match the original document.

## Contacting customer support

Before contacting customer support, make sure to have the following information:

- Printer problem
- Error message
- Printer model type and serial number

Go to <http://support.lexmark.com> to receive e-mail or chat support, or browse through the library of manuals, support documentation, drivers, and other downloads.

Technical support via telephone is also available. In the U.S. or Canada, call 1-800-539-6275. For other countries or regions, go to <http://support.lexmark.com>.

# Upgrading and migrating

## Hardware

### Available internal options

- Flash memory
- Font cards
- Firmware cards
  - Forms and Bar Code
  - IPDS
  - PRESCRIBE
- Internal solutions port
  - RS-232C Serial Interface Card
  - Parallel 1284-B Interface Card
  - MarkNet N8230 Fiber Ethernet

### Accessing the controller board



**CAUTION—SHOCK HAZARD:** To avoid the risk of electrical shock, if you are accessing the controller board or installing optional hardware or memory devices sometime after setting up the printer, then turn the printer off, and unplug the power cord from the electrical outlet before continuing. If you have any other devices attached to the printer, then turn them off as well, and unplug any cables going into the printer.

- 1 Turn off the printer.
- 2 Unplug the power cord from the electrical outlet, and then from the printer.
- 3 Using a flat-head screwdriver, open the controller board access cover.

**Warning—Potential Damage:** Controller board electronic components are easily damaged by static electricity. Touch a metal surface on the printer before touching any controller board components or connectors.

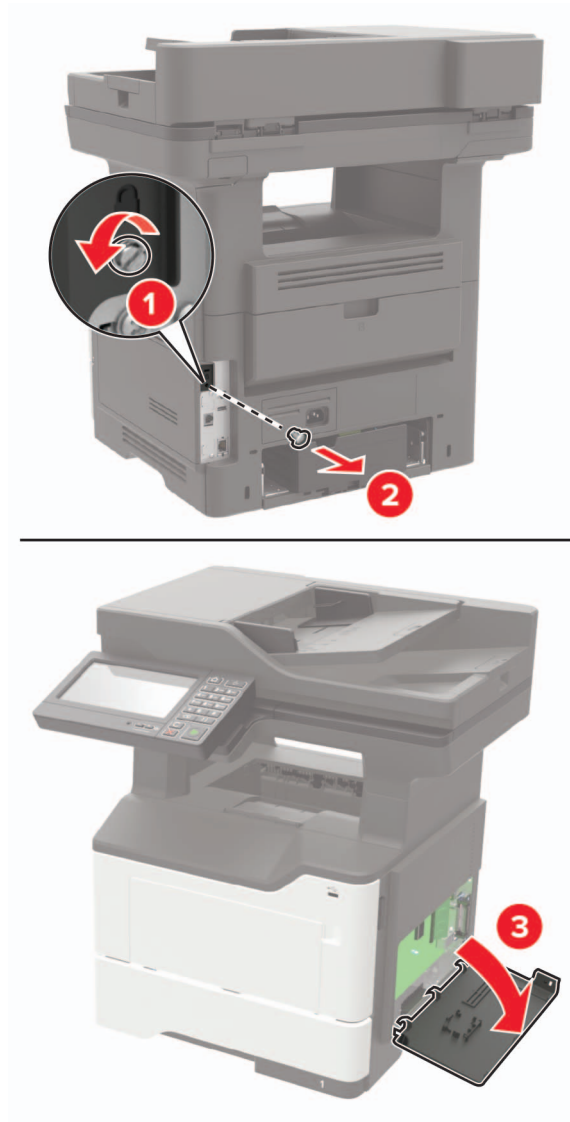

- 4 Close the access cover.
- 5 Connect the power cord to the printer, and then to the electrical outlet.
- 6 Turn on the printer.

## Installing a memory card

**⚠ CAUTION—SHOCK HAZARD:** To avoid the risk of electrical shock, if you are accessing the controller board or installing optional hardware or memory devices sometime after setting up the printer, then turn the printer off, and unplug the power cord from the electrical outlet before continuing. If you have any other devices attached to the printer, then turn them off as well, and unplug any cables going into the printer.

- 1 Turn off the printer.
- 2 Unplug the power cord from the electrical outlet, and then from the printer.
- 3 Open the controller board access cover.

**Warning—Potential Damage:** Controller board electronic components are easily damaged by static electricity. Touch a metal surface on the printer before touching any controller board components or connectors.

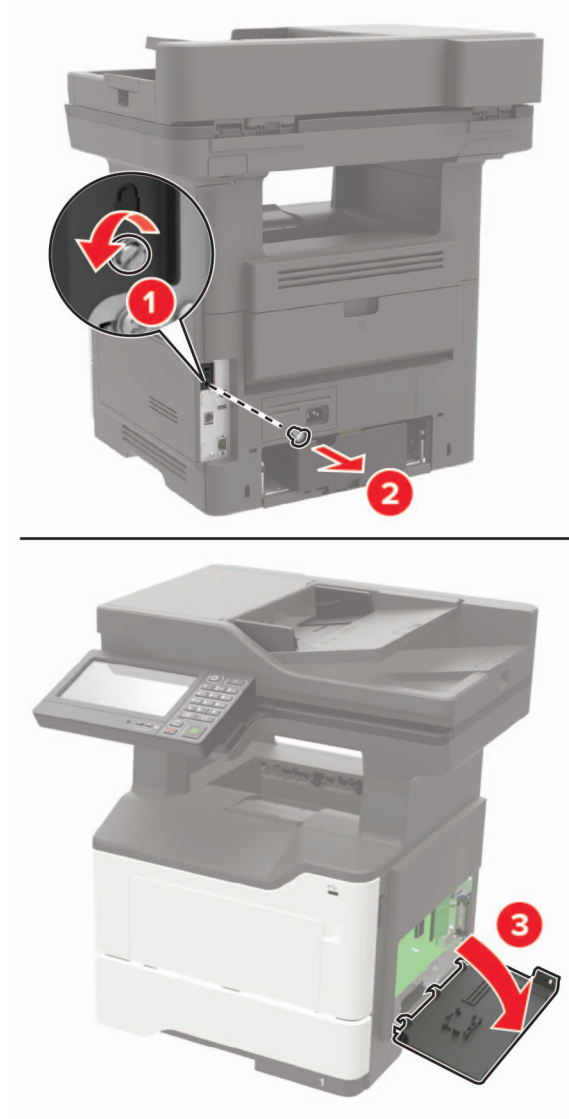

**4** Unpack the memory card.

**Warning—Potential Damage:** Do not touch the connection points along the edge of the card.

**5** Insert the memory card until it *clicks* into place.

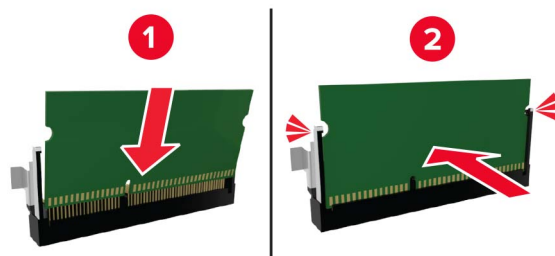

- 6 Close the controller board access cover.
- 7 Connect the power cord to the printer, and then to the electrical outlet.

 **CAUTION—POTENTIAL INJURY:** To avoid the risk of fire or electrical shock, connect the power cord to an appropriately rated and properly grounded electrical outlet that is near the product and easily accessible.

- 8 Turn on the printer.

## Installing an optional card

 **CAUTION—SHOCK HAZARD:** To avoid the risk of electrical shock, if you are accessing the controller board or installing optional hardware or memory devices sometime after setting up the printer, then turn the printer off, and unplug the power cord from the electrical outlet before continuing. If you have any other devices attached to the printer, then turn them off as well, and unplug any cables going into the printer.

- 1 Turn off the printer.
- 2 Unplug the power cord from the electrical outlet, and then from the printer.
- 3 Open the controller board access cover.

**Warning—Potential Damage:** Controller board electronic components are easily damaged by static electricity. Touch a metal surface on the printer before touching any components or connectors.

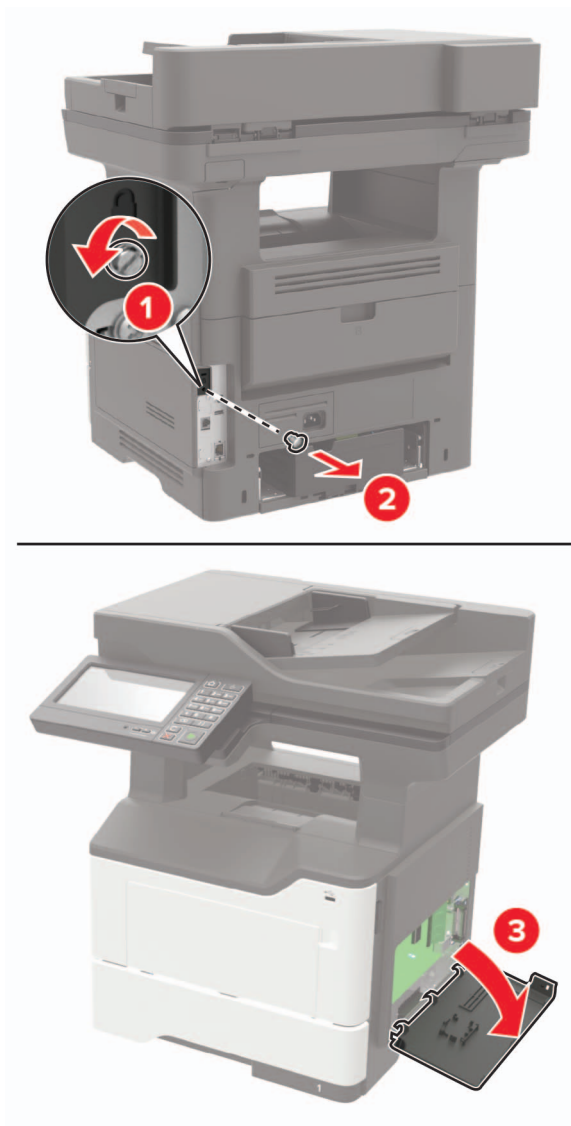

4 Unpack the optional card.

**Warning—Potential Damage:** Do not touch the connection points along the edge of the card.

- 5 Push the card firmly into place.

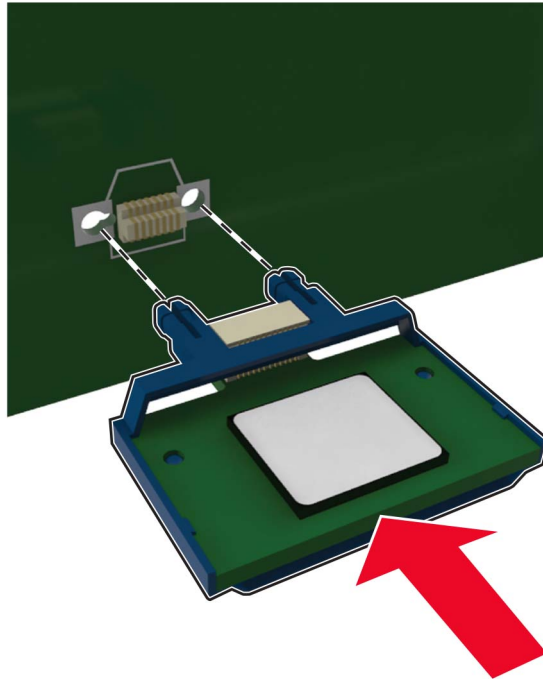

**Note:** The entire length of the connector on the card must touch and be flush against the controller board.

**Warning—Potential Damage:** Improper installation of the card may cause damage to the card and the controller board.

- 6 Close the access cover.
- 7 Connect the power cord to the printer, and then to the electrical outlet.

**CAUTION—POTENTIAL INJURY:** To avoid the risk of fire or electrical shock, connect the power cord to an appropriately rated and properly grounded electrical outlet that is near the product and easily accessible.

- 8 Turn on the printer.

## Installing a printer hard disk

**CAUTION—SHOCK HAZARD:** To avoid the risk of electrical shock, if you are accessing the controller board or installing optional hardware or memory devices sometime after setting up the printer, then turn the printer off, and unplug the power cord from the electrical outlet before continuing. If you have any other devices attached to the printer, then turn them off as well, and unplug any cables going into the printer.

- 1 Turn off the printer.
- 2 Unplug the power cord from the electrical outlet, and then from the printer.
- 3 Open the controller board access cover.



**Warning—Potential Damage:** Controller board electronic components are easily damaged by static electricity. Touch a metal surface on the printer before touching any controller board components or connectors.

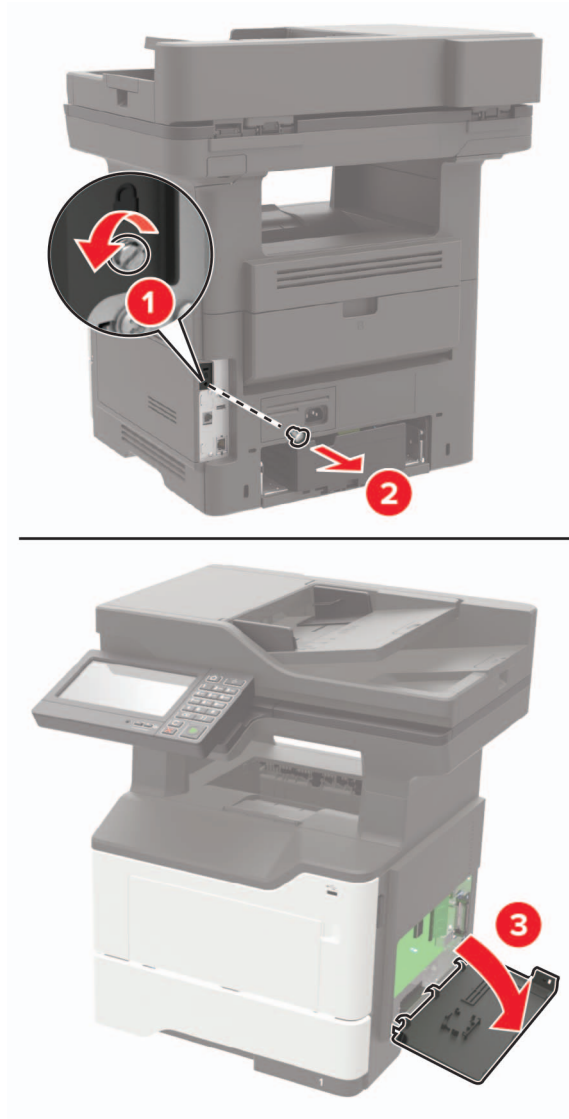

**4** Unpack the hard disk.

**5** Attach the hard disk to the controller board.

**Warning—Potential Damage:** Do not touch or press the center of the hard disk.

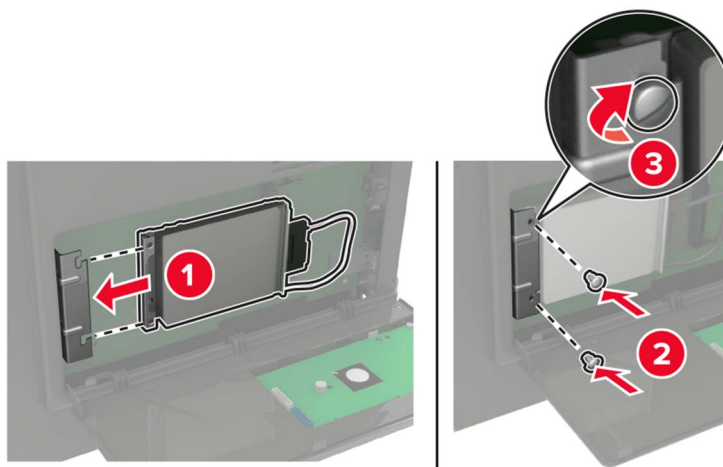

- 6 Attach the hard disk interface cable to the controller board.

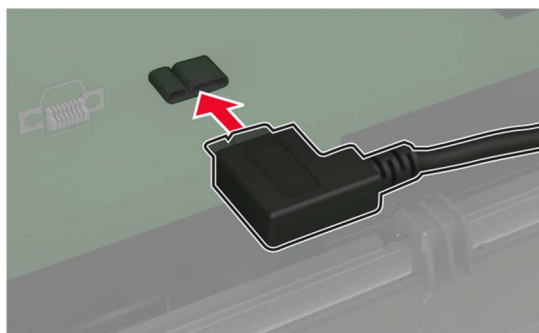

- 7 Close the access cover.  
8 Connect the power cord to the printer, and then to the electrical outlet.

**⚠ CAUTION—POTENTIAL INJURY:** To avoid the risk of fire or electrical shock, connect the power cord to an appropriately rated and properly grounded electrical outlet that is near the product and easily accessible.

- 9 Turn on the printer.

## Installing an internal solutions port

**⚠ CAUTION—SHOCK HAZARD:** To avoid the risk of electrical shock, if you are accessing the controller board or installing optional hardware or memory devices sometime after setting up the printer, then turn the printer off, and unplug the power cord from the electrical outlet before continuing. If you have any other devices attached to the printer, then turn them off as well, and unplug any cables going into the printer.

- 1 Turn off the printer.
- 2 Unplug the power cord from the electrical outlet, and then from the printer.
- 3 Unpack the internal solutions port (ISP) kit.

**Note:** Remove the preinstalled interface cable from the ISP.

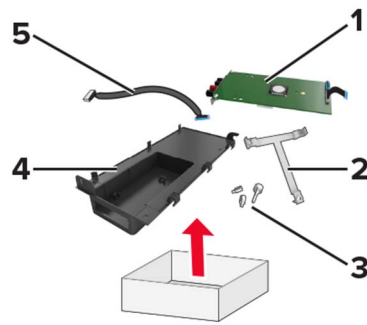

1	ISP
2	Mounting bracket
3	Thumbscrews
4	Housing
5	Interface cable

4 Install the ISP into its housing.

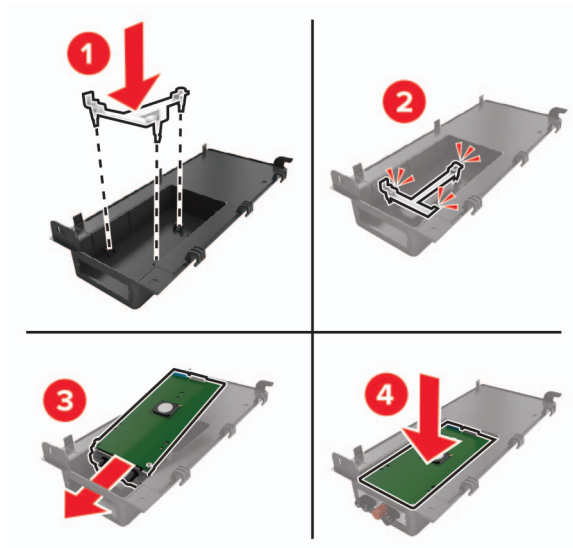

5 Secure the ISP in place and attach the ISP extended cable.

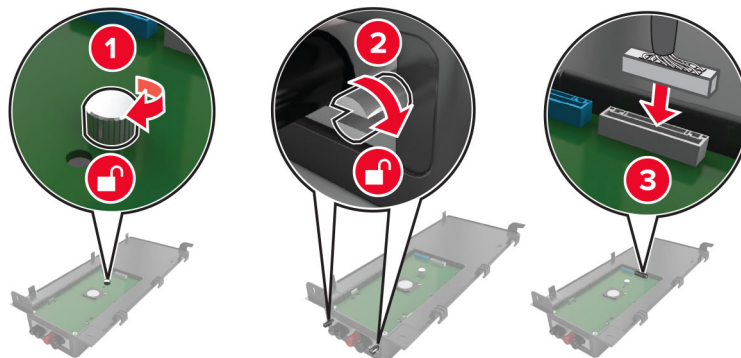

**6** Open, and then remove the controller board access cover.

**Warning—Potential Damage:** Controller board electronic components are easily damaged by static electricity. Touch a metal surface on the printer before touching any controller board electronic components or connectors.

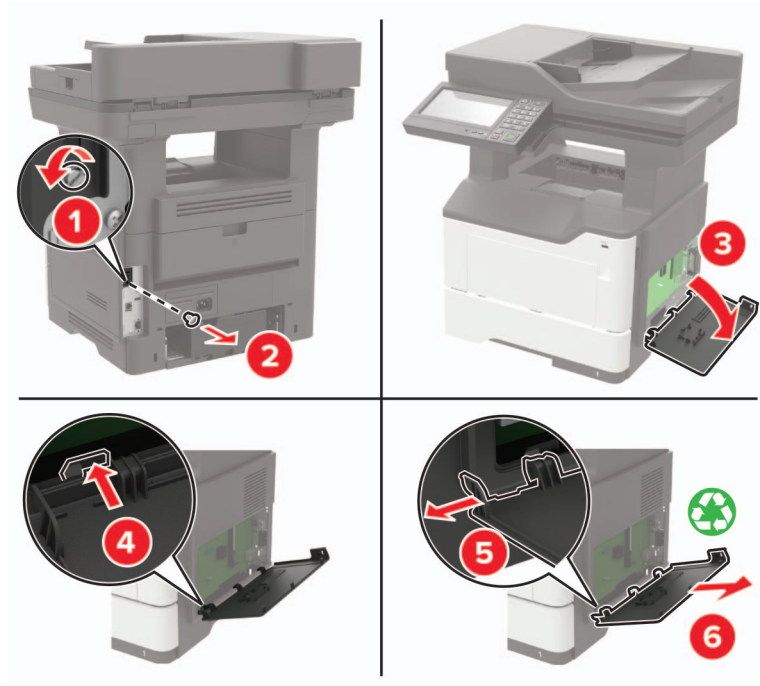
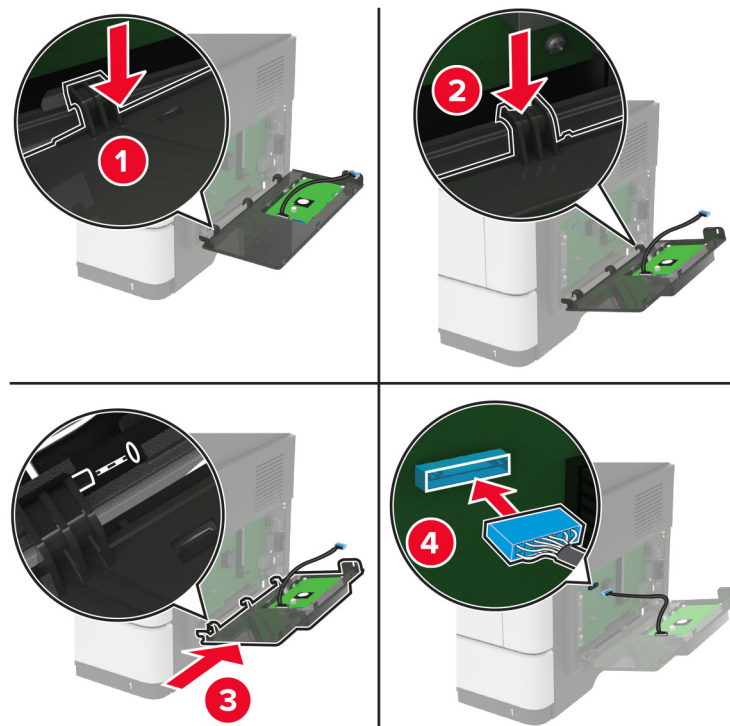
**7** Attach the ISP kit to the printer.

If a printer hard disk is installed, then remove the hard disk before installing the ISP.

- a Unplug the hard disk interface cable from the controller board.

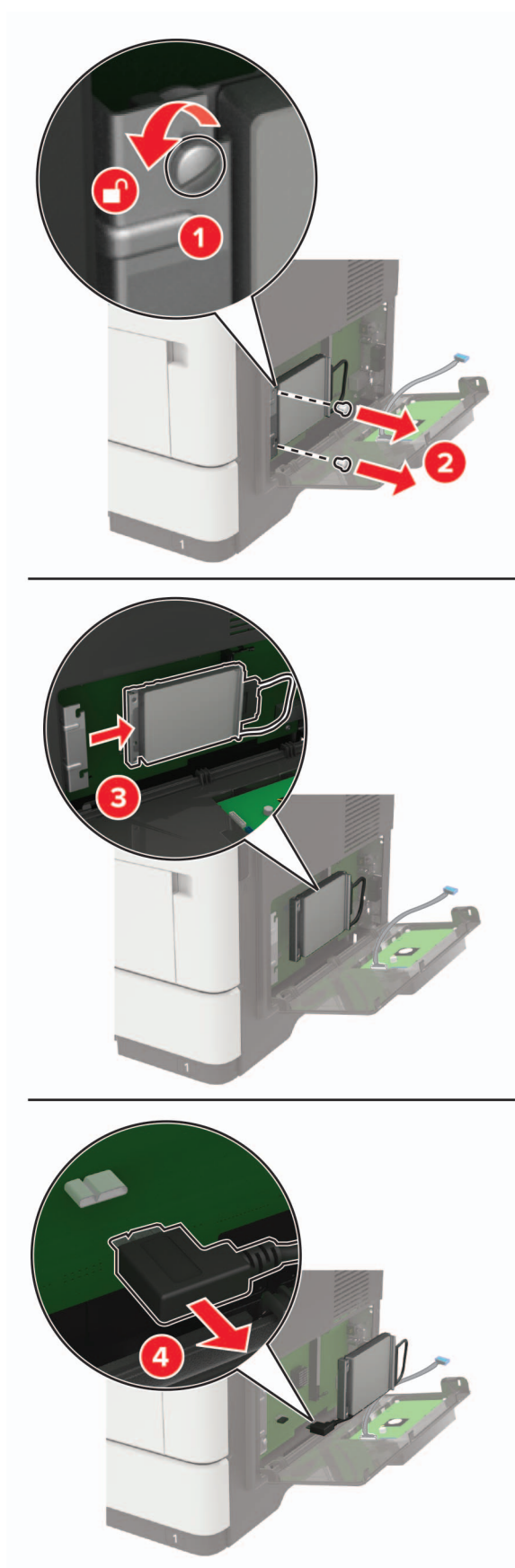

- b** Connect the ISP extended cable to the ISP connector.

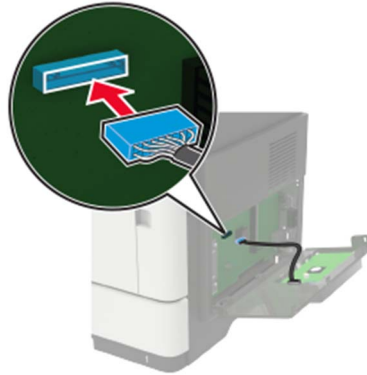

c Install the hard disk.

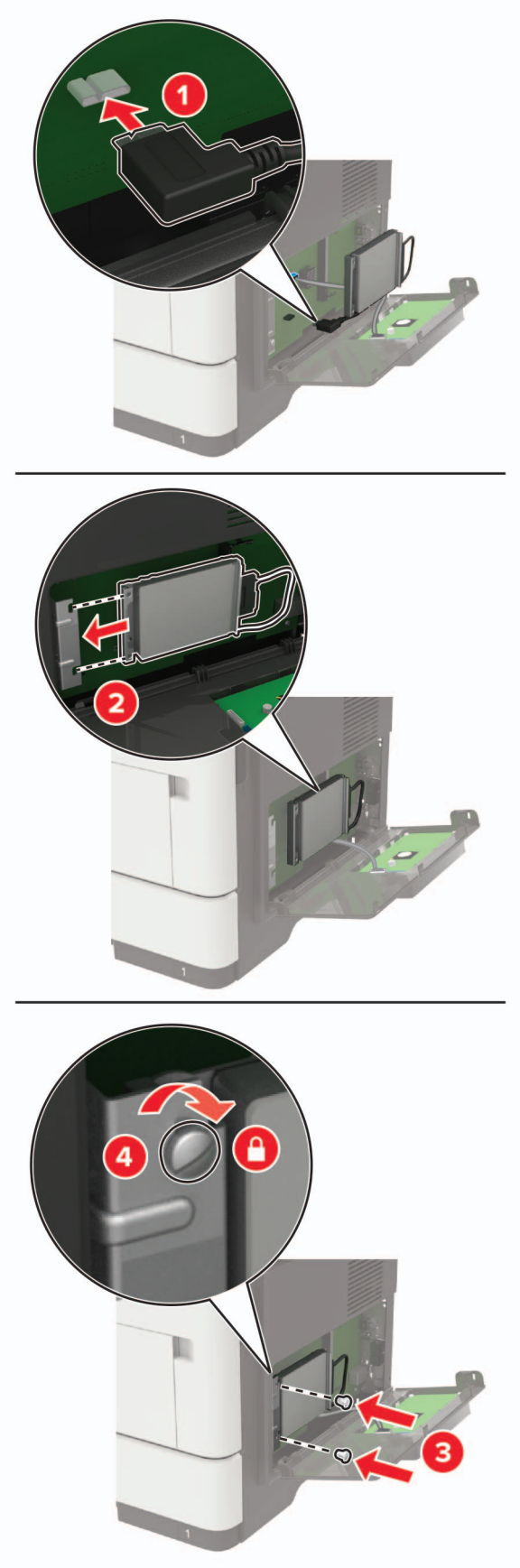

- 8 Close the access cover.
- 9 Connect the power cord to the printer, and then to the electrical outlet.

**⚠ CAUTION—POTENTIAL INJURY:** To avoid the risk of fire or electrical shock, connect the power cord to an appropriately rated and properly grounded electrical outlet that is near the product and easily accessible.

- 10 Turn on the printer.

## Installing optional trays

**⚠ CAUTION—SHOCK HAZARD:** To avoid the risk of electrical shock, if you are accessing the controller board or installing optional hardware or memory devices sometime after setting up the printer, then turn the printer off, and unplug the power cord from the electrical outlet before continuing. If you have any other devices attached to the printer, then turn them off as well, and unplug any cables going into the printer.

- 1 Turn off the printer.
- 2 Unplug the power cord from the electrical outlet, and then from the printer.
- 3 Unpack the optional tray, and then remove all packing material.

**Note:** If optional trays are already installed, then unlock them from the printer before lifting the printer. Do not try to lift the printer and trays at the same time.

- 4 Align the printer with the optional tray, and then lower the printer until it *clicks* into place.

**⚠ CAUTION—POTENTIAL INJURY:** If the printer weight is greater than 18 kg (40 lb), then it requires two or more trained personnel to lift it safely.



- 5 Connect the power cord to the printer, and then to the electrical outlet.

**⚠ CAUTION—POTENTIAL INJURY:** To avoid the risk of fire or electrical shock, connect the power cord to an appropriately rated and properly grounded electrical outlet that is near the product and easily accessible.

- 6 Turn on the printer.



Add the tray in the print driver to make it available for print jobs. For more information, see [“Adding available options in the print driver” on page 242](#).

## Software

### Supported operating systems

Using the software CD, you can install the printer software on the following operating systems:

- Windows 10
- Windows 8.1
- Windows Server 2012 R2
- Windows Server 2012
- Windows 7 SP1
- Windows Server 2008 R2 SP1
- Windows Server 2008 SP2
- Windows Vista SP2
- Mac OS X version 10.7 or later
- Red Hat Enterprise Linux WS
- openSUSE Linux
- SUSE Linux Enterprise Server
- Debian GNU/Linux
- Ubuntu
- Fedora
- IBM AIX
- Oracle Solaris SPARC
- Oracle Solaris x86

#### Notes:

- For Windows operating systems, the print drivers and utilities are supported in both 32- and 64-bit versions.
- For drivers and utilities that are compatible with Mac OS X version 10.6 or earlier and for specific supported Linux or UNIX operating system versions, go to <http://support.lexmark.com>.
- For more information on software compatibility with all other operating systems, contact customer support.

### Installing the printer software

- 1 Obtain a copy of the software installer package.
  - From the software CD that came with your printer.
  - Go to <http://support.lexmark.com>, and then select your printer and operating system.
- 2 Run the installer, and then follow the instructions on the computer screen.

- 3 For Macintosh users, add the printer.

**Note:** Obtain the printer IP address from the TCP/IP section in the Network/Ports menu.

## Adding available options in the print driver

### For Windows users

- 1 Open the printers folder.
- 2 Select the printer you want to update, and then do either of the following:
  - For Windows 7 or later, select **Printer properties**.
  - For earlier versions, select **Properties**.
- 3 Navigate to the Configuration tab, and then select **Update Now - Ask Printer**.
- 4 Apply the changes.

### For Macintosh users

- 1 From System Preferences in the Apple menu, navigate to your printer, and then select **Options & Supplies**.
- 2 Navigate to the list of hardware options, and then add any installed options.
- 3 Apply the changes.

## Firmware

### Exporting or importing a configuration file

You can export the configuration settings of your printer into a text file, and then import the file to apply the settings to other printers.

- 1 Open a web browser, and then type the printer IP address in the address field.

**Notes:**

- View the printer IP address on the printer home screen. The IP address appears as four sets of numbers separated by periods, such as 123.123.123.123.
- If you are using a proxy server, then temporarily disable it to load the web page correctly.

- 2 Export or import a configuration file for one or multiple applications.

#### For one application

- a From the Embedded Web Server, click **Apps** > the application that you want > **Configure**.
- b Click **Export** or **Import**.

#### For multiple applications

- a From the Embedded Web Server, click **Export Configuration** or **Import Configuration**.
- b Follow the instructions on the screen.

## Updating firmware

Some applications require a minimum device firmware level to operate correctly.

For more information on updating the device firmware, contact your Lexmark representative.

- 1** From the Embedded Web Server, click **Settings > Device > Update Firmware**.
- 2** Browse to locate the required flash file.
- 3** Apply the changes.

# Notices

## Product information

Product name:

Lexmark MB2650ade; Lexmark MX622ade, MX622adhe; Lexmark XM3250

Machine type:

7018

Model(s):

676, 678, 679

## Edition notice

April 2018

**The following paragraph does not apply to any country where such provisions are inconsistent with local law:** LEXMARK INTERNATIONAL, INC., PROVIDES THIS PUBLICATION "AS IS" WITHOUT WARRANTY OF ANY KIND, EITHER EXPRESS OR IMPLIED, INCLUDING, BUT NOT LIMITED TO, THE IMPLIED WARRANTIES OF MERCHANTABILITY OR FITNESS FOR A PARTICULAR PURPOSE. Some states do not allow disclaimer of express or implied warranties in certain transactions; therefore, this statement may not apply to you.

This publication could include technical inaccuracies or typographical errors. Changes are periodically made to the information herein; these changes will be incorporated in later editions. Improvements or changes in the products or the programs described may be made at any time.

References in this publication to products, programs, or services do not imply that the manufacturer intends to make these available in all countries in which it operates. Any reference to a product, program, or service is not intended to state or imply that only that product, program, or service may be used. Any functionally equivalent product, program, or service that does not infringe any existing intellectual property right may be used instead. Evaluation and verification of operation in conjunction with other products, programs, or services, except those expressly designated by the manufacturer, are the user's responsibility.

For Lexmark technical support, visit <http://support.lexmark.com>.

For information on supplies and downloads, visit [www.lexmark.com](http://www.lexmark.com).

© 2018 Lexmark International, Inc.

All rights reserved.

## GOVERNMENT END USERS

The Software Program and any related documentation are "Commercial Items," as that term is defined in 48 C.F.R. 2.101, "Computer Software" and "Commercial Computer Software Documentation," as such terms are used in 48 C.F.R. 12.212 or 48 C.F.R. 227.7202, as applicable. Consistent with 48 C.F.R. 12.212 or 48 C.F.R. 227.7202-1 through 227.7207-4, as applicable, the Commercial Computer Software and Commercial Software Documentation are licensed to the U.S. Government end users (a) only as Commercial Items and (b) with only those rights as are granted to all other end users pursuant to the terms and conditions herein.

## Trademarks

Lexmark, the Lexmark logo, and MarkNet are trademarks or registered trademarks of Lexmark International, Inc. in the United States and/or other countries.

Google Cloud Print and Google Chrome are trademarks of Google Inc.

Macintosh, the Mac logo, and Safari are trademarks of Apple Inc.

Microsoft, Windows, and Internet Explorer are either registered trademarks or trademarks of the Microsoft group of companies in the United States and other countries.

Mopria®, the Mopria® logo, and the Mopria® Alliance logo are registered trademarks and service marks of Mopria Alliance, Inc. in the United States and other countries. Unauthorized use is strictly prohibited.

PCL® is a registered trademark of the Hewlett-Packard Company. PCL is Hewlett-Packard Company’s designation of a set of printer commands (language) and functions included in its printer products. This printer is intended to be compatible with the PCL language. This means the printer recognizes PCL commands used in various application programs, and that the printer emulates the functions corresponding to the commands.

PostScript is a registered trademark of Adobe Systems Incorporated in the United States and/or other countries.

All other trademarks are the property of their respective owners.

AirPrint and the AirPrint logo are trademarks of Apple, Inc.

## Licensing notices

All licensing notices associated with this product can be viewed from the CD:\NOTICES directory of the installation software CD.

## Noise emission levels

The following measurements were made in accordance with ISO 7779 and reported in conformance with ISO 9296.

**Note:** Some modes may not apply to your product.

1-meter average sound pressure, dBA	
Printing	One-sided: 55; Two-sided: 54
Scanning	56
Copying	56
Ready	14

Values are subject to change. See [www.lexmark.com](http://www.lexmark.com) for current values.

## Waste from Electrical and Electronic Equipment (WEEE) directive



The WEEE logo signifies specific recycling programs and procedures for electronic products in countries of the European Union. We encourage the recycling of our products.

If you have further questions about recycling options, visit the Lexmark Web site at [www.lexmark.com](http://www.lexmark.com) for your local sales office phone number.

## India E-Waste notice

This product complies with the India E-Waste (Management and Handling) Rules, 2011, which prohibit use of lead, mercury, hexavalent chromium, polybrominated biphenyls, or polybrominated diphenyl ethers in concentrations exceeding 0.1% by weight and 0.01% by weight for cadmium, except for the exemption set in Schedule II of the Rules.

## Product disposal

Do not dispose of the printer or supplies in the same manner as normal household waste. Consult your local authorities for disposal and recycling options.

## Static sensitivity notice



This symbol identifies static-sensitive parts. Do not touch the areas near these symbols without first touching a metal surface in an area away from the symbol.

## ENERGY STAR

Any Lexmark product bearing the ENERGY STAR emblem on the product or on a start-up screen is certified to comply with Environmental Protection Agency (EPA) ENERGY STAR requirements as configured when shipped by Lexmark.



## Temperature information

Ambient operating temperature	10 to 32°C (50 to 90°F)
Shipping temperature	-20 to 40°C (-4 to 104°F)
Storage temperature and relative humidity	0 to 40°C (32 to 104°F) 8 to 80% RH

## Laser notice

The printer is certified in the U.S. to conform to the requirements of DHHS 21 CFR, Chapter I, Subchapter J for Class I (1) laser products, and elsewhere is certified as a Class I laser product conforming to the requirements of IEC 60825-1: 2014.

Class I laser products are not considered to be hazardous. The printer contains internally a Class IIIb (3b) AlGaInP laser that is nominally 15 milliwatts operating in the wavelength region of 650–670 nanometers and enclosed in a non-serviceable printhead assembly. The laser system and printer are designed so there is never any human access to laser radiation above a Class I level during normal operation, user maintenance, or prescribed service conditions.

## Laser advisory label

A laser notice label may be affixed to this printer as shown:

<p>DANGER - Invisible laser radiation when cartridges are removed and interlock defeated. Avoid exposure to laser beam.</p> <p>PERIGO - Radiação a laser invisível será liberada se os cartuchos forem removidos e o lacre rompido. Evite a exposição aos feixes de laser.</p> <p>Opasnost - Nevidljivo lasersko zračenje kada su kasete uklonjene i poništena sigurnosna veza. Izbjegavati izlaganje zracima.</p> <p>NEBEZPEČÍ - Když jsou vyjmuty kazety a je odblokována pojistka, ze zařízení je vysíláno neviditelné laserové záření. Nevystavujte se působení laserového paprsku.</p> <p>FARE - Usynlig laserstråling, når patroner fjernes, og spærreanordningen er slået fra. Undgå at blive udsat for laserstrålen.</p> <p>GEVAAR - Onzichtbare laserstraling wanneer cartridges worden verwijderd en een vergrendeling wordt genegeerd. Voorkom blootstelling aan de laser.</p>
---

DANGER - Rayonnements laser invisibles lors du retrait des cartouches et du déverrouillage des loquets. Eviter toute exposition au rayon laser.

VAARA - Näkymätöntä lasersäteilyä on varottava, kun värikasetit on poistettu ja lukitus on auki. Vältä lasersäteelle altistumista.

GEFAHR - Unsichtbare Laserstrahlung beim Herausnehmen von Druckkassetten und offener Sicherheitssperre. Laserstrahl meiden.

KΙΝΔΥΝΟΣ - Έκλυση αόρατης ακτινοβολίας laser κατά την αφαίρεση των κασετών και την απασφάλιση της μανδάλωσης. Αποφεύγετε την έκθεση στην ακτινοβολία laser.

VESZÉLY – Nem látható lézersugárzás fordulhat elő a patronok eltávolításakor és a zárószerkezet felbontásakor. Kerülje a lézersugárnak való kitettséget.

PERICOLO - Emissione di radiazioni laser invisibili durante la rimozione delle cartucce e del blocco. Evitare l'esposizione al raggio laser.

FARE – Usynlig laserstråling når kassettene tas ut og sperren er satt ut av spill. Unngå eksponering for laserstrålen.

NIEBEZPIECZENSTWO - niewidzialne promieniowanie laserowe podczas usuwania kaset i blokady. Należy unikać naświetlenia promieniem lasera.

ОПАСНО! Невидимое лазерное излучение при извлеченных картриджах и снятии блокировки. Избегайте воздействия лазерных лучей.

Pozor – Nebezpečnostvo neviditeľného laserového žiarenia pri odobratých kazetách a odblokovanej poistke. Nevystavujte sa lúčom.

PELIGRO: Se producen radiaciones láser invisibles al extraer los cartuchos con el interbloqueo desactivado. Evite la exposición al haz de láser.

FARA – Osynlig laserstrålning när patroner tas ur och spärrmekanismen är upphävd. Undvik exponering för laserstrålen.

危険 - 当移除碳粉盒及互锁失效时会产生看不见的激光辐射，请避免暴露在激光光束下。

危険 - 移除碳粉匣與安全連鎖開關失效時會產生看不見的雷射輻射。請避免曝露在雷射光束下。

危険 - カートリッジが取り外され、内部ロックが無効になると、見えないレーザー光が放射されます。このレーザー光に当たらないようにしてください。

## Power consumption

### Product power consumption

The following table documents the power consumption characteristics of the product.

**Note:** Some modes may not apply to your product.

Mode	Description	Power consumption (Watts)
Printing	The product is generating hard-copy output from electronic inputs.	670 (one-sided); 410 (two-sided)
Copy	The product is generating hard-copy output from hard-copy original documents.	680
Scan	The product is scanning hard-copy documents.	23.5
Ready	The product is waiting for a print job.	16.5
Sleep Mode	The product is in a high-level energy-saving mode.	2.5



Mode	Description	Power consumption (Watts)
Hibernate	The product is in a low-level energy-saving mode.	0.1
Off	The product is plugged into an electrical outlet, but the power switch is turned off.	0.1

The power consumption levels listed in the previous table represent time-averaged measurements. Instantaneous power draws may be substantially higher than the average.

Values are subject to change. See [www.lexmark.com](http://www.lexmark.com) for current values.

### Sleep Mode

This product is designed with an energy-saving mode called *Sleep Mode*. The Sleep Mode saves energy by lowering power consumption during extended periods of inactivity. The Sleep Mode is automatically engaged after this product is not used for a specified period of time, called the *Sleep Mode Timeout*.

Factory default Sleep Mode Timeout for this product (in minutes):	15
---	----

By using the configuration menus, the Sleep Mode Timeout can be modified between 1 minute and 120 minutes. Setting the Sleep Mode Timeout to a low value reduces energy consumption, but may increase the response time of the product. Setting the Sleep Mode Timeout to a high value maintains a fast response, but uses more energy.

### Hibernate Mode

This product is designed with an ultra-low power operating mode called *Hibernate mode*. When operating in Hibernate Mode, all other systems and devices are powered down safely.

The Hibernate mode can be entered in any of the following methods:

- Using the Hibernate Timeout
- Using the Schedule Power modes

Factory default Hibernate Timeout for this product in all countries or regions	3 days
--	--------

The amount of time the printer waits after a job is printed before it enters Hibernate mode can be modified between one hour and one month.

### Off mode

If this product has an off mode which still consumes a small amount of power, then to completely stop product power consumption, disconnect the power supply cord from the electrical outlet.

### Total energy usage

It is sometimes helpful to calculate the total product energy usage. Since power consumption claims are provided in power units of Watts, the power consumption should be multiplied by the time the product spends in each mode in order to calculate energy usage. The total product energy usage is the sum of each mode's energy usage.

## Regulatory notices for telecommunication terminal equipment

This section contains regulatory information pertaining to products that contain the analog facsimile card:

Lexmark Regulatory Type/Model Number:

LEX-M14-002

### Notice to users of the US telephone network: FCC requirements

This equipment complies with Part 68 of the FCC rules and the requirements adopted by the Administrative Council for Terminal Attachments (ACTA). On the back of this equipment is a label that contains, among other information, a product identifier in the format US:AAAEQ##TXXXX. If requested, this number must be provided to your telephone company.

This equipment uses the RJ-11C Universal Service Order Code (USOC) jack.

A plug and jack used to connect this equipment to the premises' wiring and telephone network must comply with the applicable FCC Part 68 rules and requirements adopted by the ACTA. Use a compliant telephone cord (RJ-11) that is 26 AWG or larger when connecting this product to the public switched telephone network. See your setup documentation for more information.

The Ringer Equivalence Number (REN) is used to determine the number of devices that may be connected to a telephone line. Excessive RENs on a telephone line may result in the devices not ringing in response to an incoming call. In most but not all areas, the sum of RENs should not exceed five (5.0). To be certain of the number of devices that may be connected to a line, as determined by the total RENs, contact your local telephone company. For products approved after July 23, 2001, the REN for this product is part of the product identifier that has the format US:AAAEQ##TXXXX. The digits represented by ## are the REN without a decimal point (for example, 03 is a REN of 0.3). For earlier products, the REN is shown separately on the label.

If this equipment causes harm to the telephone network, the telephone company will notify you in advance that temporary discontinuance of service may be required. If advance notice is not practical, the telephone company will notify the customer as soon as possible. You will also be advised of your right to file a complaint with the FCC.

The telephone company may make changes in its facilities, equipment, operations or procedures that could affect the operation of this equipment. If this happens, the telephone company will provide advance notice in order for you to make necessary modifications to maintain uninterrupted service.

If you experience trouble with this equipment, for repair or warranty information, contact Lexmark International, Inc. at [www.lexmark.com](http://www.lexmark.com) or your Lexmark representative. If the equipment is causing harm to the telephone network, the telephone company may request that you disconnect the equipment until the problem is resolved.

This equipment contains no user serviceable parts. For repair and warranty information, contact Lexmark International, Inc. See the previous paragraph for contact information.

Connection to party line service is subject to state tariffs. Contact the state public utility commission, public service commission, or corporation commission for information.

If your home has specially wired alarm equipment connected to the telephone line, ensure the installation of this equipment does not disable your alarm equipment. If you have questions about what will disable alarm equipment, consult your telephone company or a qualified installer.

The Telephone Consumer Protection Act of 1991 makes it unlawful for any person to use a computer or other electronic device, including fax machines, to send any message unless said message clearly contains in a margin at the top or bottom of each transmitted page or on the first page of the transmission, the date and time it is sent and an identification of the business or other entity, or other individual sending the message, and the

telephone number of the sending machine or such business, other entity, or individual. (The telephone number provided may not be a 900 number or any other number for which charges exceed local or long-distance transmission charges.)

See your user documentation in order to program this information into your fax machine.

## **Notice to users of the Canadian telephone network**

This product meets the applicable Industry Canada technical specifications.

The Ringer Equivalence Number (REN) indicates the maximum number of devices allowed to be connected to a telephone interface. The termination of an interface may consist of any combination of devices subject only to the requirement that the sum of the RENs of all the devices not exceed five. The REN is located on the product label.

This equipment uses CA11A telephone jacks.

### **Avis réservé aux utilisateurs du réseau téléphonique du Canada**

Ce produit est conforme aux spécifications techniques d'Industrie Canada.

Le numéro REN (ringer equivalence number : numéro d'équivalence de sonnerie) indique le nombre maximum d'appareils pouvant être connectés à l'interface téléphonique. En bout de ligne, le nombre d'appareils qui peuvent être connectés n'est pas directement limité, mais la somme des REN de ces appareils ne doit pas dépasser cinq. Le numéro REN est indiqué sur l'étiquette produit.

Cet équipement utilise des prises de téléphone CA11A.

## **Notice to users of the New Zealand telephone network**

The following are special conditions for the Facsimile User Instructions. The grant of a telepermit for any item of terminal equipment indicates only that Telecom has accepted that the item complies with minimum conditions for connection to its network. It indicates no endorsement of the product by Telecom, nor does it provide any sort of warranty. Above all, it provides no assurance that any item will work correctly in all respects with another item of telepermitted equipment of a different make or model, nor does it imply that any product is compatible with all of Telecom's network services.

This equipment shall not be set up to make automatic calls to the Telecom "111" Emergency Service.

This equipment may not provide for the effective hand-over of a call to another device connected to the same line.

This equipment should not be used under any circumstances that may constitute a nuisance to other Telecom customers.

This equipment is not capable, under all operating conditions, of correct operation at the higher speeds for which it is designed. Telecom will accept no responsibility should difficulties arise in such circumstances.

The decadic (or pulse) dialing on this device is unsuitable for use on the Telecom network in New Zealand.

For correct operation, the total of all the Ringer Equivalence Numbers (RENs) of all parallel devices connected to the same telephone line may not exceed 5. The REN of this device is located on the label.

This device uses an RJ-11C modular connector. Contact your point of purchase if a BT adapter is required. The Lexmark part number is 80D1873.

Some parameters required for compliance with Telecom's telepermit requirements are dependent on the equipment associated with this device. The associated equipment shall be set to operate within the following limits for compliance to Telecom's specifications:

- There shall be no more than 10 call attempts to the same number within any 30 minute period for any single manual call initiation, and
- The equipment shall go on-hook for a period of not less than 30 seconds between the end of one attempt and the beginning of the next call attempt.
- The equipment shall be set to ensure that automatic calls to different numbers are spaced such that there is not less than 5 seconds between the end of one call attempt and the beginning of another.

## Japanese telecom notice

The installed optional modem is in compliance with Japanese Telecommunication Law and has been Certified by JATE, with Certification Number A11-0160001.

	Lexmark International, Inc.
	LEX-M14-002
	A11-0160001JP

## Using this product in Switzerland

This product requires a Swiss billing tone filter (Lexmark part number 80D1877) to be installed on any line which receives metering pulses in Switzerland.

## Utilisation de ce produit en Suisse

Cet appareil nécessite l'utilisation d'un filtre de tonalité de facturation suisse (n° de référence Lexmark : 80D1877) devant être installé sur toute ligne recevant des impulsions de comptage en Suisse.

## Verwendung dieses Produkts in der Schweiz

Für dieses Produkt muss ein schweizerischer Billing Tone Filter zur Zählzeichenübertragung (Lexmark Teilenummer 80D1877) für jede Leitung installiert werden, über die in der Schweiz Zeitsteuertakte übertragen werden.

## Uso del prodotto in Svizzera

Questo prodotto richiede un filtro toni Billing svizzero, (codice Lexmark 80D1877) da installare su tutte le linee che ricevono impulsi remoti in Svizzera.

## Regulatory notices for wireless products

This section contains regulatory information that applies only to wireless models.

If in doubt as to whether your model is a wireless model, go to <http://support.lexmark.com>.

## Modular component notice

This product may contain the following modular component(s):

Lexmark Regulatory Type/LEX-M01-005; FCC ID: IYLLEXM01005; Industry Canada IC: 2376A-M01005

## Exposure to radio frequency radiation

The radiated output power of this device is far below the radio frequency exposure limits of the FCC and other regulatory agencies. A minimum separation of 20 cm (8 inches) must be maintained between the antenna and any persons for this device to satisfy the RF exposure requirements of the FCC and other regulatory agencies.

## Industry Canada (Canada)

Under Industry Canada regulations, this radio transmitter may only operate using an antenna of a type and maximum (or lesser) gain approved for the transmitter by Industry Canada. To reduce potential radio interference to other users, the antenna type and its gain should be so chosen that the equivalent isotropically radiated power (EIRP) is not more than that necessary for successful communication.

This device complies with Industry Canada license-exempt RSS standards. Operation is subject to the following two conditions: (1) this device may not cause interference, and (2) this device must accept any interference, including interference that may cause undesired operation of the device.

To prevent radio interference to the licensed service and to reduce the potential for harmful interference to co-channel mobile satellite systems, this device is intended to be operated indoors and away from windows to provide maximum shielding.

High-power radars are allocated as primary users (i.e., priority users) of the bands 5250–5350MHz and 5650–5850MHz. These radars could cause interference and/or damage to LE-LAN devices.

## Industrie Canada (Canada)

Selon la réglementation d'Industrie Canada, l'émetteur radio ne fonctionne qu'avec une antenne dont le type et le gain maximal (ou inférieur) ont été approuvés par Industrie Canada. Pour réduire les interférences radio potentielles auprès d'autres utilisateurs, le type d'antenne et son gain doivent être choisis de telle sorte que la puissance isotrope rayonnée équivalente (PIRE) ne soit pas supérieure à ce qui est nécessaire pour assurer la réussite de la communication.

Cet appareil est conforme aux normes RSS exemptes de licence d'Industrie Canada. Son fonctionnement est soumis aux deux conditions suivantes : (1) cet appareil ne doit pas causer d'interférences et (2) il doit accepter toutes les interférences, y compris les celles qui peuvent entraîner un fonctionnement indésirable.

Afin de prévenir les interférences radio des services sous licence et pour réduire le risque d'interférences nuisibles aux systèmes de satellites mobiles utilisant les mêmes canaux, cet appareil est destiné à être utilisé à l'intérieur et loin des fenêtres afin de fournir une protection maximale.

Les radars à haute puissance sont définis comme les utilisateurs principaux (p. ex., utilisateurs prioritaires) dans les bandes de 5250-5350 MHz et 5650-5850 MHz. Ces radars peuvent causer des interférences ou des dommages aux appareils RELOC-EL.

### European Community (EC) directives conformity

This product is in conformity with the protection requirements of EC Council directive 2014/53/EU on the approximation and harmonization of the laws of the Member States relating to radio equipment.

The manufacturer of this product is: Lexmark International, Inc., 740 West New Circle Road, Lexington, KY, 40550 USA. The authorized representative is: Lexmark International Technology Hungária Kft., 8 Lechner Ödön fasor, Millennium Tower III, 1095 Budapest HUNGARY. A declaration of conformity to the requirements of the Directives is available upon request from the Authorized Representative or may be obtained at [www.lexmark.com/en\\_us/about/regulatory-compliance/european-union-declaration-of-conformity.html](http://www.lexmark.com/en_us/about/regulatory-compliance/european-union-declaration-of-conformity.html).

Compliance is indicated by the CE marking:



### Restrictions

This radio equipment is restricted to indoor use only. Outdoor use is prohibited. This restriction applies to all the countries listed in the table below:

								
AT	BE	BG	CH	CY	CZ	DE	DK	EE
EL	ES	FI	FR	HR	HU	IE	IS	IT
LI	LT	LU	LV	MT	NL	NO	PL	PT
RO	SE	SI	SK	TR	UK			

### EU statement of radio transmitter operational frequency bands and maximum RF power

This radio product transmits in either the 2.4GHz (2.412–2.472 GHz in the EU) or 5GHz (5.15–5.35, 5.47–5.725 in the EU) bands. The maximum transmitter EIRP power output, including antenna gain, is ≤ 20dBm for both bands.

## **Federal Communications Commission (FCC) compliance information statement**

This product has been tested and found to comply with the limits for a Class A digital device, pursuant to Part 15 of the FCC Rules. Operation is subject to the following two conditions: (1) this device may not cause harmful interference, and (2) this device must accept any interference received, including interference that may cause undesired operation.

The FCC Class A limits are designed to provide reasonable protection against harmful interference when the equipment is operated in a commercial environment. This equipment generates, uses, and can radiate radio frequency energy and, if not installed and used in accordance with the instruction manual, may cause harmful interference to radio communications. Operation of this equipment in a residential area is likely to cause harmful interference, in which case the user will be required to correct the interference at his own expense.

The manufacturer is not responsible for any radio or television interference caused by using other than recommended cables or by unauthorized changes or modifications to this equipment. Unauthorized changes or modifications could void the user's authority to operate this equipment.

**Note:** To assure compliance with FCC regulations on electromagnetic interference for a Class A computing device, use a properly shielded and grounded cable such as Lexmark part number 1021231 for parallel attach or 1021294 for USB attach. Use of a substitute cable not properly shielded and grounded may result in a violation of FCC regulations.

Any questions regarding this compliance information statement should be directed to:

Director of Lexmark Technology & Services  
Lexmark International, Inc.  
740 West New Circle Road  
Lexington, KY 40550  
Telephone: (859) 232-3000  
E-mail: regulatory@lexmark.com

## **Industry Canada compliance statement**

This Class A digital apparatus meets all requirements of the Canadian Interference-Causing Equipment Standard ICES-003.

## **Avis de conformité aux normes de l'industrie du Canada**

Cet appareil numérique de classe A est conforme aux exigences de la norme canadienne relative aux équipements pouvant causer des interférences NMB-003.

## **Notice to users of Class A products in Brazil**

Este produto não é apropriado para uso em ambientes domésticos, pois poderá causar interferências eletromagnéticas que obrigam o usuário a tomar medidas necessárias para minimizar estas interferências.

## **European Community (EC) directives conformity**

This product is in conformity with the protection requirements of EC Council directives 2014/30/EU, 2014/35/EU, and 2011/65/EU on the approximation and harmonization of the laws of the Member States relating to

electromagnetic compatibility, safety of electrical equipment designed for use within certain voltage limits, and on the restrictions of use of certain hazardous substances in electrical and electronic equipment.

The manufacturer of this product is: Lexmark International, Inc., 740 West New Circle Road, Lexington, KY, 40550 USA. The authorized representative is: Lexmark International Technology Hungária Kft., 8 Lechner Ödön fasor, Millennium Tower III, 1095 Budapest HUNGARY. A declaration of conformity to the requirements of the Directives is available upon request from the Authorized Representative or may be obtained at [www.lexmark.com/en\\_us/about/regulatory-compliance/european-union-declaration-of-conformity.html](http://www.lexmark.com/en_us/about/regulatory-compliance/european-union-declaration-of-conformity.html).

This product satisfies the Class A limits of EN 55022 and EN55032 and safety requirements of EN 60950-1 or EN 62368-1.

## Radio interference notice

### Warning

This is a product that complies with the emission requirements of EN55022 and EN55032 Class A limits and immunity requirements of EN55024. This product is not intended to be used in residential/domestic environments.

This is a Class A product. In a domestic environment, this product may cause radio interference, in which case the user may be required to take adequate measures.

## STATEMENT OF LIMITED WARRANTY FOR LEXMARK LASER PRINTERS, LEXMARK LED PRINTERS, AND LEXMARK MULTIFUNCTION LASER PRINTERS

### Lexmark International, Inc., Lexington, KY

This limited warranty applies to the United States and Canada. For customers outside the U.S., refer to the country-specific warranty information that came with your product.

This limited warranty applies to this product only if it was originally purchased for your use, and not for resale, from Lexmark or a Lexmark Remarketer, referred to in this statement as "Remarketer."

### Limited warranty

Lexmark warrants that this product:

- Is manufactured from new parts, or new and serviceable used parts, which perform like new parts
- Is, during normal use, free from defects in material and workmanship

If this product does not function as warranted during the warranty period, contact a Remarketer or Lexmark for repair or replacement (at Lexmark's option).

If this product is a feature or option, this statement applies only when that feature or option is used with the product for which it was intended. To obtain warranty service, you may be required to present the feature or option with the product.

If you transfer this product to another user, warranty service under the terms of this statement is available to that user for the remainder of the warranty period. You should transfer proof of original purchase and this statement to that user.



## Limited warranty service

The warranty period starts on the date of original purchase as shown on the purchase receipt and ends 12 months later provided that the warranty period for any supplies and for any maintenance items included with the printer shall end earlier if it, or its original contents, are substantially used up, depleted, or consumed. Fuser Units, Transfer/Transport Units, Paper Feed items, if any, and any other items for which a Maintenance Kit is available are substantially consumed when the printer displays a “Life Warning” or “Scheduled Maintenance” message for such item.

To obtain warranty service you may be required to present proof of original purchase. You may be required to deliver your product to the Remarketer or Lexmark, or ship it prepaid and suitably packaged to a Lexmark designated location. You are responsible for loss of, or damage to, a product in transit to the Remarketer or the Lexmark designated location.

When warranty service involves the exchange of a product or part, the item replaced becomes the property of the Remarketer or Lexmark. The replacement may be a new or repaired item.

The replacement item assumes the remaining warranty period of the original product.

Replacement is not available to you if the product you present for exchange is defaced, altered, in need of a repair not included in warranty service, damaged beyond repair, or if the product is not free of all legal obligations, restrictions, liens, and encumbrances.

As part of your warranty service and/or replacement, Lexmark may update the firmware in your printer to the latest version. Firmware updates may modify printer settings and cause counterfeit and/or unauthorized products, supplies, parts, materials (such as toners and inks), software, or interfaces to stop working. Authorized use of genuine Lexmark products will not be impacted.

Before you present this product for warranty service, remove all print cartridges, programs, data, and removable storage media (unless directed otherwise by Lexmark).

For further explanation of your warranty alternatives and the nearest Lexmark authorized servicer in your area contact Lexmark on the World Wide Web.

Remote technical support is provided for this product throughout its warranty period. For products no longer covered by a Lexmark warranty, technical support may not be available or only be available for a fee.

## Extent of limited warranty

Lexmark does not warrant uninterrupted or error-free operation of any product or the durability or longevity of prints produced by any product.

Warranty service does not include repair of failures caused by:

- Modification or unauthorized attachments
- Accidents, misuse, abuse or use inconsistent with Lexmark user’s guides, manuals, instructions or guidance
- Unsuitable physical or operating environment
- Maintenance by anyone other than Lexmark or a Lexmark authorized servicer
- Operation of a product beyond the limit of its duty cycle
- Use of printing media outside of Lexmark specifications
- Refurbishment, repair, refilling or remanufacture by a third party of products, supplies or parts
- Products, supplies, parts, materials (such as toners and inks), software, or interfaces not furnished by Lexmark

**TO THE EXTENT PERMITTED BY APPLICABLE LAW, NEITHER LEXMARK NOR ITS THIRD PARTY SUPPLIERS OR REMARKETERS MAKE ANY OTHER WARRANTY OR CONDITION OF ANY KIND, WHETHER EXPRESS OR IMPLIED, WITH RESPECT TO THIS PRODUCT, AND SPECIFICALLY DISCLAIM THE IMPLIED WARRANTIES OR CONDITIONS OF MERCHANTABILITY, FITNESS FOR A PARTICULAR PURPOSE, AND SATISFACTORY QUALITY. ANY WARRANTIES THAT MAY NOT BE DISCLAIMED UNDER APPLICABLE LAW ARE LIMITED IN DURATION TO THE WARRANTY PERIOD. NO WARRANTIES, EXPRESS OR IMPLIED, WILL APPLY AFTER THIS PERIOD. ALL INFORMATION, SPECIFICATIONS, PRICES, AND SERVICES ARE SUBJECT TO CHANGE AT ANY TIME WITHOUT NOTICE.**

### **Limitation of liability**

Your sole remedy under this limited warranty is set forth in this document. For any claim concerning performance or nonperformance of Lexmark or a Remarketer for this product under this limited warranty, you may recover actual damages up to the limit set forth in the following paragraph.

Lexmark's liability for actual damages from any cause whatsoever will be limited to the amount you paid for the product that caused the damages. This limitation of liability will not apply to claims by you for bodily injury or damage to real property or tangible personal property for which Lexmark is legally liable. **IN NO EVENT WILL LEXMARK BE LIABLE FOR ANY LOST PROFITS, LOST SAVINGS, INCIDENTAL DAMAGE, OR OTHER ECONOMIC OR CONSEQUENTIAL DAMAGES.** This is true even if you advise Lexmark or a Remarketer of the possibility of such damages. Lexmark is not liable for any claim by you based on a third party claim.

This limitation of remedies also applies to claims against any Suppliers and Remarketers of Lexmark. Lexmark's and its Suppliers' and Remarketers' limitations of remedies are not cumulative. Such Suppliers and Remarketers are intended beneficiaries of this limitation.

### **Additional rights**

Some states do not allow limitations on how long an implied warranty lasts, or do not allow the exclusion or limitation of incidental or consequential damages, so the limitations or exclusions contained above may not apply to you.

This limited warranty gives you specific legal rights. You may also have other rights that vary from state to state.

# Index

## A

- About this Printer menu 68
- accessing the controller board 227
- activating Voice Guidance 24
- adapter plug 46
- adding contacts 22
- adding groups 23
- adding hardware options
  - print driver 242
- adding internal options
  - print driver 242
- adjusting
  - ADF registration 226
  - scanner registration 226
- adjusting speech rate
  - Voice Guidance 25
- adjusting the brightness
  - printer display 165
- adjusting the brightness of the printer display 165
- adjusting the default headphone volume 141
- adjusting the default speaker volume 141
- adjusting toner darkness 217
- AirPrint
  - using 34
- answering machine
  - setting up 44
- attaching cables 14
- avoiding paper jams 167

## B

- blank pages 190
- blocking junk faxes 52
- bookmarks
  - creating 21
  - creating folders for 22

## C

- cable
  - Ethernet 14
  - USB 14
- canceling a print job
  - from the computer 38

- from the printer control panel 38
- cannot open Embedded Web Server 182
- Card Copy
  - setting up 18
- changing the printer port settings after installing ISP 143
- changing the wallpaper 19
- checking the status of parts and supplies 148
- cleaning
  - exterior of the printer 144
  - interior of the printer 144
- cleaning the printer 144
- cleaning the scanner 136, 145
- clearing jam
  - in door A 169
  - in door B 173
- clearing jams
  - in the finisher 178
- Cloud Connector profile
  - creating 21
  - printing from 37
- collated printing does not work 188
- collating copies 40
- confidential print jobs 36
  - printing from a Macintosh computer 36
  - printing from Windows 36
- configuring daylight saving time 50
- configuring e-mail settings 42
- configuring fax speaker settings 141
- configuring supply notifications 151
- connecting printer to distinctive ring service 49
- connecting the printer
  - to a wireless network 142
- connecting to a wireless network
  - using PIN method 142
  - using Push Button method 142
- conservation settings
  - Eco-Mode 165
  - hibernate mode 165
  - sleep mode 165
- conserving supplies 166
- contacting customer support 226
- contacts
  - adding 22
  - deleting 23
  - editing 23
- control panel
  - using 15
- controller board
  - accessing 227
- copy troubleshooting
  - partial copies of documents or photos 223
  - poor copy quality 223
  - scanner does not respond 225
  - scanner unit does not close 225
- copying
  - both sides of the paper 39
  - creating a shortcut 40
  - on letterhead 39
- copying different paper sizes 39
- copying from
  - selected tray 39
- copying multiple pages
  - onto a single sheet 40
- copying photos 39
- creating a Cloud Connector profile 21
- creating a copy shortcut 40
- creating a fax destination shortcut 51
- creating a shortcut
  - copy 40
  - e-mail 43
  - fax destination 51
  - FTP address 53
- creating an e-mail shortcut 43
- creating an FTP shortcut 53
- creating bookmarks 21
- creating folders
  - for bookmarks 22
- crooked print 203
- Customer Support
  - using 19

customer support  
  contacting 226  
customizing the display 19

## D

date and time  
  fax settings 50  
daylight saving time,  
  configuring 50  
deactivating the Wi-Fi  
  network 143  
default headphone volume  
  adjusting 141  
default speaker volume  
  adjusting 141  
Defective flash detected 185  
deleting contacts 23  
deleting groups 23  
Device Quotas  
  setting up 20  
different paper sizes, copying 39  
directory list  
  printing 37  
Display Customization  
  using 19  
distinctive ring service, fax  
  connecting to 49  
documents, printing  
  from a computer 33  
  from a mobile device 33  
dots on print 201

## E

Eco-Mode setting 165  
Eco-Settings  
  configuring 19  
editing contacts 23  
editing groups 23  
emission notices 245, 253, 255  
enabling Magnification mode 24  
enabling personal identification  
  numbers 25  
enabling spoken passwords 25  
enabling the USB port 183  
encrypting the printer hard  
  disk 139  
enlarging copies 40  
environmental setting  
  Eco-Mode 165  
environmental settings  
  hibernate mode 165

  sleep mode 165  
erasing printer hard disk  
  memory 138  
erasing printer memory 139  
Ethernet menu 117  
Ethernet port 14  
exporting a configuration file  
  using the Embedded Web  
  Server 242  
exporting compressed logs 68  
exporting configuration file 68  
e-mail  
  creating a shortcut 43  
  setting up 42  
e-mailing  
  configuring e-mail settings 42  
  using a shortcut number 42  
  using the address book 42  
  using the printer 42

## F

fax log  
  viewing 51  
fax port 14  
fax resolution  
  changing 51  
fax setup  
  country- or region-specific 46  
  standard telephone line  
  connection 44  
fax speaker settings  
  configuring 141  
fax troubleshooting  
  cannot receive faxes 221  
  cannot send faxes 221  
  cannot send or receive  
  faxes 219  
  received fax has poor print  
  quality 222  
faxing  
  adjusting darkness 51  
  blocking junk faxes 52  
  changing resolution 51  
  creating a shortcut 51  
  fax setup 44  
  forwarding faxes 52  
  holding faxes 52  
  setting the date and time 50  
  viewing a fax log 51  
FCC notices 253  
finding more information about  
  the printer 10

firmware  
  update 243  
flash drive  
  printing from 34  
  scanning to 54  
Flash Drive Print menu 113  
folder paper 194  
font sample list  
  printing 37  
forwarding faxes 52  
FTP address  
  creating a shortcut 53  
FTP server, scanning to  
  using the control panel 53

## G

Google Cloud Print  
  using 33  
green settings  
  Eco-Mode 165  
  hibernate mode 165  
  sleep mode 165  
groups  
  adding 23  
  deleting 23  
  editing 23

## H

hardware options  
  trays 240  
hardware options, adding  
  print driver 242  
held jobs 36  
  printing from a Macintosh  
  computer 36  
  printing from Windows 36  
Help menu 136  
hibernate mode  
  setting 165  
holding faxes 52  
home screen  
  customizing 18  
  showing icons 18  
home screen icons  
  using 17  
HTTP/FTP Settings menu 123

## I

icons on the home screen  
  showing 18  
identifying jam locations 168

- imaging unit
  - ordering 150
  - replacing 154
- importing a configuration file
  - using the Embedded Web Server 242
- indicator light
  - understanding the status 15
- installing a memory card 228
- installing a printer hard disk 232
- installing an internal solutions port 234
- installing an optional card 230
- installing options
  - printer hard disk 232
- installing the printer software 241
- internal option is not detected 184
- internal options
  - firmware cards 227
  - flash memory 227
  - font cards 227
  - installing 230
  - internal solutions port 227
  - memory card 228
  - printer hard disk 232
- internal options, adding
  - print driver 242
- internal solutions port
  - installing 234
  - troubleshooting 185
- IPSec menu 121
- J**
- jam, clearing
  - finisher 180
- jams
  - avoiding 167
- jams, clearing
  - in the automatic document feeder 177
  - in the duplex unit 175
  - in the multipurpose feeder 176
  - in the standard bin 174
  - trays 176
- K**
- keyboard on the display
  - using 25
- L**
- letterhead
  - copying on 39
- Lexmark Mobile Print
  - using 33
- LINE port 14
- linking trays 29
- loading
  - multipurpose feeder 28
- loading envelopes
  - in the multipurpose feeder 28
- loading trays 26
- locating paper jams 168
- locating the security slot 138
- M**
- Magnification mode
  - enabling 24
- maintenance kit
  - ordering 150
- making copies 39
- Media Types menu 80
- memory card
  - installing 228
- menu
  - 802.1x 123
  - Accessibility 62
  - Confidential Print Setup 132
  - Configuration Menu 63
  - Copy Defaults 80
  - Custom Scan Sizes 79
  - Device 135
  - Erase Temporary Data Files 133
  - Ethernet 117
  - E-mail Defaults 98
  - E-mail Setup 96
  - Fax 135
  - Fax Cover Page 92
  - Fax Log Settings 92
  - Fax Mode 84
  - Fax Receive Settings 89
  - Fax Send Settings 85
  - Fax Server E-mail Settings 94
  - Fax Server Scan Settings 95
  - Finishing 70
  - Flash Drive Print 113
  - Flash Drive Scan 108
  - FTP Defaults 104
  - General Fax Settings 84, 93
  - Google Cloud Print 125
  - HTML 76
  - HTTP/FTP Settings 123
  - Image 77
  - Information Sent to Lexmark 62
  - IPSec 121
  - Job Accounting 72
  - Layout 68
  - Local Accounts 128
  - Login Restrictions 132
  - LPD Configuration 123
  - Manage Permissions 127
  - Media Types 80
  - Menu Settings Page 135
  - Miscellaneous 134
  - Mobile Services
    - Management 134
  - Network 136
  - Network Overview 114
  - Notifications 59
  - Out of Service Erase 67
  - PCL 75
  - PDF 74
  - PostScript 74
  - Power Management 61
  - Preferences 57
  - Print 135
  - Quality 71
  - Remote Operator Panel 59
  - Security Audit Log 129
  - Setup 70
  - Shortcuts 135
  - SNMP 120
  - Solutions LDAP Settings 134
  - Speaker Settings 93
  - TCP/IP 119
  - ThinPrint 124
  - Tray Configuration 78
  - Troubleshooting 136
  - Universal Setup 79
  - USB 125
  - Web Link Setup 103
  - Wi-Fi Direct 126
  - XPS 73
- menu map 56
- Menu Settings Page
  - printing 137
- menus
  - About this Printer 68
  - Disk Encryption 133
  - Help 136
  - Restore Factory Defaults 63
  - Schedule USB Devices 129
  - Visible Home Screen Icons 67

Wireless 115  
mobile device  
  printing from 33, 34  
Mopria Print Service  
  using 33  
mottled print 201  
moving the printer 11, 164  
multipurpose feeder  
  loading 28

## N

navigating the screen  
  using gestures 24  
navigating the screen using  
  gestures 24  
network setup page  
  printing 184  
noise emission levels 245  
Non-Lexmark supply 187  
non-volatile memory 139  
  erasing 138  
Not enough free space in flash  
  memory for resources 186  
  notices 245, 246, 247, 248,  
  249, 253, 255

## O

operating systems  
  supported 241  
optional card  
  installing 230  
options  
  internal solutions port 234  
ordering  
  imaging unit 150  
  maintenance kit 150  
  staple cartridges 151  
ordering supplies  
  toner cartridge 148

## P

paper  
  Universal size setting 26  
paper jam in door A 169  
paper jam in door B 173  
paper jam in the automatic  
  document feeder 177  
paper jam in the duplex unit 175  
paper jam in the finisher 178  
paper jam in the multipurpose  
  feeder 176

paper jam in trays 176  
paper jam, clearing  
  in door B 173  
  in the automatic document  
  feeder 177  
  in the duplex unit 175  
  in the multipurpose feeder 176  
  trays 176  
paper jams  
  avoiding 167  
paper jams, clearing  
  in the standard bin 174  
paper size  
  setting 26  
paper type  
  setting 26  
personal identification number  
  method 142  
personal identification numbers  
  enabling 25  
photos  
  copying 39  
pick roller assembly  
  replacing 160  
pick tires  
  replacing 158  
placing separator sheets  
  between copies  
  copying 40  
power button light  
  understanding the status 15  
print driver  
  hardware options, adding 242  
print job  
  canceling from the  
  computer 38  
  canceling from the printer  
  control panel 38  
print jobs not printed 216  
print quality troubleshooting  
  blank or white pages 190  
  crooked or skewed print 203  
  dark print 192  
  fine lines are not printed  
  correctly 193  
  folded or wrinkled paper 194  
  gray background on prints 195  
  horizontal light bands 197  
  light print 199  
  mottled print and dots 201  
  paper curl 202  
  repeating defects 204

solid black pages 205  
text or images cut off 206  
toner easily rubs off 208  
vertical dark bands 208  
vertical dark lines or  
  streaks 210  
vertical dark streaks with print  
  missing 211  
vertical light bands 212  
vertical white lines 213  
print troubleshooting  
  confidential and other held  
  documents do not print 214  
  envelope seals when  
  printing 187  
  incorrect margins 198  
  jammed pages are not  
  reprinted 190  
  job prints from the wrong  
  tray 218  
  job prints on the wrong  
  paper 218  
  paper frequently jams 189  
  print jobs do not print 216  
  slow printing 215  
  tray linking does not work 189  
  unable to read flash drive 183  
printer  
  minimum clearances 11  
  selecting a location 11  
  shipping 165  
printer display  
  adjusting the brightness 165  
printer hard disk  
  encrypting 139  
printer hard disk encryption 139  
printer hard disk memory 139  
  erasing 138  
printer information  
  finding 10  
printer is not responding 217  
printer menus 56, 68  
printer messages  
  Defective flash detected 185  
  Non-Lexmark supply 187  
  Not enough free space in flash  
  memory for resources 186  
  Replace cartridge, printer region  
  mismatch 186  
  Unformatted flash detected 186

- printer options troubleshooting
  - cannot detect internal option 184
  - internal solutions port 185
- printer port settings
  - changing 143
- printer ports 14
- printer settings
  - restoring to factory defaults 139
- printer software, installing 241
- printer status 15
- printing
  - directory list 37
  - font sample list 37
  - from a Cloud Connector profile 37
  - from a computer 33
  - from a flash drive 34
  - from a mobile device 34
  - Menu Settings Page 137
  - network setup page 184
  - quality test pages 136
  - printing a directory list 37
  - printing a font sample list 37
  - printing a network setup page 184
  - printing confidential and other held jobs
    - from a Macintosh computer 36
    - from Windows 36
  - printing from a computer 33
  - printing from a flash drive 34
  - Push Button method 142
- Q**
- QR codes
  - adding 20
- R**
- recycling
  - Lexmark packaging 166
  - Lexmark products 166
  - toner cartridges 166
- reducing copies 40
- removing paper jam
  - in door A 169
- repeat print jobs 36
  - printing from a Macintosh computer 36
  - printing from Windows 36
- Replace cartridge, printer region mismatch 186
- replacing supplies
  - imaging unit 154
  - staple cartridge 156
  - toner cartridge 152
- replacing the pick roller assembly 160
- replacing the pick tires 158
- replacing the staple cartridge 156
- reserve print jobs
  - printing from a Macintosh computer 36
  - printing from Windows 36
- resetting
  - supply usage counters 187
- resetting the supply usage counters 187
- restoring factory default settings 139
- RJ11 adapter 46
- running a slideshow 19
- S**
- safety information 8, 9
- saving paper 40
- saving toner 40
- Scan Center
  - setting up 20
- Scan to Computer
  - setting up 55
- scan troubleshooting
  - cannot scan from a computer 222
  - partial copies of documents or photos 223
  - poor copy quality 223
  - scan job was not successful 224
  - scanner does not respond 225
  - scanner unit does not close 225
  - scanning freezes the computer 225
  - scanning takes too long 225
  - vertical dark streaks on output when scanning from the ADF 223
- scanner
  - cleaning 145
- scanning
  - to an FTP server 53
- scanning quality problem 223
- scanning to a computer 55
- scanning to a flash drive 54
- scanning to an FTP server
  - using the control panel 53
- scheduling a fax 51
- securing printer memory 139
- security slot
  - locating 138
- selecting a location for the printer 11
- sending a fax
  - scheduled 51
  - using the computer 50
  - using the control panel 50
- sending an e-mail 42
- serial printing
  - setting up 143
- setting hibernate mode 165
- setting sleep mode 165
- setting the paper size 26
- setting the paper type 26
- setting the Universal paper size 26
- setting up Device Quotas 20
- setting up e-mail function 42
- setting up fax
  - country- or region-specific 46
  - standard telephone line connection 44
- setting up fax function 44
- setting up serial printing 143
- shipping the printer 165
- Shortcut Center
  - using 19
- showing icons on the home screen 18
- skewed print 203
- speaker
  - default volume 141
- spoken passwords
  - enabling 25
- staple cartridge
  - replacing 156
- staple cartridges
  - ordering 151
- staple jam in the finisher 180
- staple jam, clearing
  - finisher 180
- statement of volatility 139

- status of parts
  - checking 148
- status of supplies
  - checking 148
- storing print jobs 36
- supplies
  - conserving 166
- supplies, ordering
  - maintenance kit 150
  - staple cartridges 151
- supply notifications
  - configuring 151
- supply usage counters
  - resetting 187
- supported file types 35
- supported flash drives 35
- supported operating systems 241
- supported paper sizes 30
- supported paper types 32
- supported paper weights 32

## T

- toner cartridge
  - ordering 148
  - replacing 152
- toner cartridges
  - recycling 166
- toner darkness
  - adjusting 217
- trays
  - installing 240
  - loading 26
- troubleshooting
  - cannot open Embedded Web Server 182
  - printer is not responding 217
- troubleshooting, copy
  - partial copies of documents or photos 223
  - poor copy quality 223
  - scanner does not respond 225
  - scanner unit does not close 225
- troubleshooting, fax
  - cannot receive faxes 221
  - cannot send faxes 221
  - cannot send or receive faxes 219
  - received fax has poor print quality 222

- troubleshooting, print
  - collated printing does not work 188
  - confidential and other held documents do not print 214
  - envelope seals when printing 187
  - incorrect margins 198
  - jammed pages are not reprinted 190
  - job prints from the wrong tray 218
  - job prints on the wrong paper 218
  - paper frequently jams 189
  - print jobs do not print 216
  - slow printing 215
  - tray linking does not work 189
- troubleshooting, print quality
  - blank or white pages 190
  - crooked or skewed print 203
  - dark print 192
  - fine lines are not printed correctly 193
  - folded or wrinkled paper 194
  - gray background on prints 195
  - horizontal light bands 197
  - light print 199
  - mottled print and dots 201
  - paper curl 202
  - repeating defects 204
  - solid black pages 205
  - text or images cut off 206
  - toner easily rubs off 208
  - vertical dark bands 208
  - vertical dark lines or streaks 210
  - vertical dark streaks with print missing 211
  - vertical light bands 212
  - vertical white lines 213
- troubleshooting, printer options
  - cannot detect internal option 184
  - internal solutions port 185
- troubleshooting, scan
  - cannot scan from a computer 222
  - partial copies of documents or photos 223
  - poor copy quality 223

- scan job was not successful 224
- scanner does not respond 225
- scanner unit does not close 225
- vertical dark streaks on output when scanning from the ADF 223
- two-sided copying 39

## U

- unable to read flash drive
  - troubleshooting, print 183
- Unformatted flash detected 186
- Universal paper size
  - setting 26
- unlinking trays 29
- updating firmware
  - flash file 243
- USB port 14
  - enabling 183
- using
  - genuine Lexmark parts 148
  - genuine Lexmark supplies 148
  - using Customer Support 19
  - using Display Customization 19
  - using QR Code Generator 20
  - using the ADF
    - copying 39
  - using the control panel 15
  - using the home screen 17
  - using the scanner glass
    - copying 39

## V

- verify print jobs 36
  - printing from a Macintosh computer 36
  - printing from Windows 36
- vertical dark lines on prints 210
- vertical dark streaks on output when scanning from the ADF 223
- vertical streaks on prints 210
- viewing a fax log 51
- virtual keyboard
  - using 25
- Voice Guidance
  - activating 24
  - speech rate 25



Voice Guidance speech rate  
adjusting 25  
volatile memory 139  
erasing 138

## **W**

white lines 213  
white pages 190  
Wireless menu 115  
wireless network  
connecting the printer to 142  
Wi-Fi Protected Setup 142  
wireless networking 142  
Wi-Fi network  
deactivating 143  
Wi-Fi Protected Setup  
wireless network 142  
wrinkled paper 194