

First Steps Quick Guide

TASKalfa 2321 TASKalfa 2021

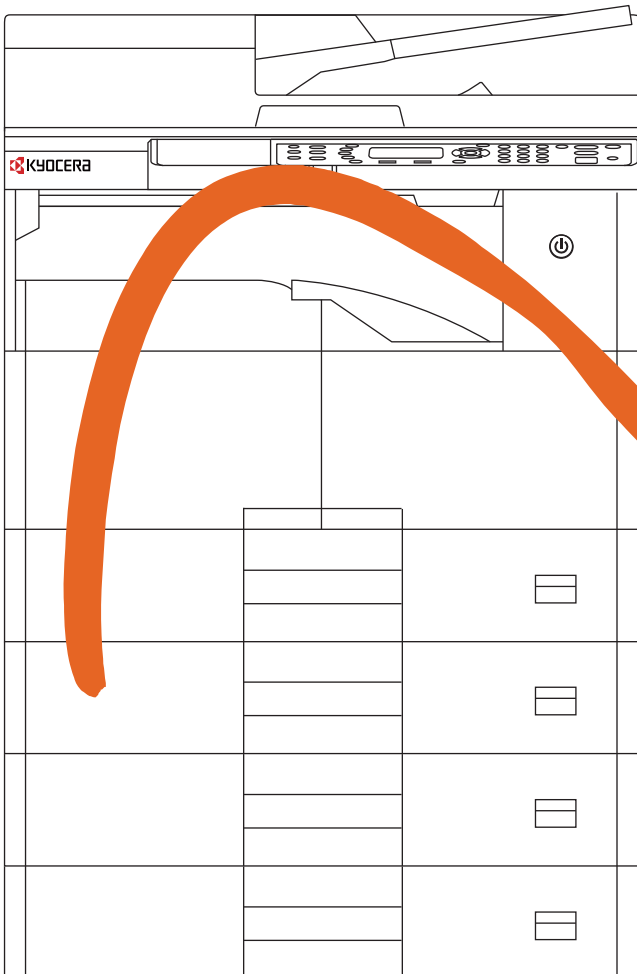

Preface

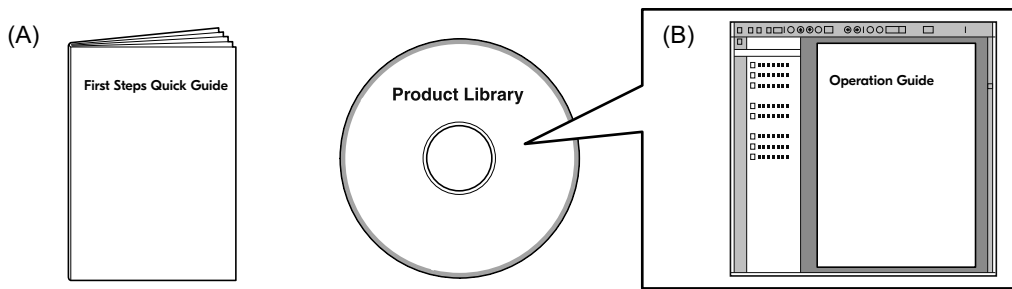

- EN** This guide (A) only explains the basic operations of the machine.
For other information, see Operation Guide (B) on the Product Library disc.
- CS** Tento průvodce (A) vysvětluje pouze základní obsluhu zařízení.
Bližší informace naleznete v Návodu k obsluze (B) na disku Product Library.
- DA** Denne vejledning (A) forklarer kun de grundlæggende funktioner af maskinen.
Andre oplysninger findes i Betjeningsvejledning (B) på Product Library disken.
- DE** Dieser Leitfaden (A) erläutert nur die grundlegende Bedienung des Geräts.
Für weitere Informationen, siehe Bedienungsanleitung (B) in der Product Library auf dem Datenträger.
- EL** Οι παρούσες οδηγίες (A) επεξηγούν μόνο τις βασικές λειτουργίες του μηχανήματος.
Για άλλες πληροφορίες, ανατρέξτε στις Οδηγίες χρήσης (B) στο δίσκο Product Library.
- ES** En esta guía (A) solo se explican los procedimientos básicos de la máquina.
Para obtener otra información, consulte la Guía de uso (B) en el disco Product Library.
- FI** Tässä oppaassa (A) kuvataan vain laitteen perustoiminnot.
Katso tarkemmat tiedot Product Library -levyn Käyttöopas (B).
- FR** Ce guide (A) explique uniquement les opérations de base de la machine.
Pour toute autre information, se reporter au Manuel d'utilisation (B) sur le disque Product Library.
- HU** Ez az útmutató (A) csak a készülék alapvető működését ismerteti.
Bővebb információért lásd a Használati útmutatót (B) a Product Library lemezen.
- IT** Questa guida (A) descrive solo le funzioni base del dispositivo.
Per ulteriori informazioni, vedere la Guida alle funzioni (B) sul disco Product Library.
- KO** 이 설명서(A)에서는 본 기기의 기본적인 작동에 대해서만 설명합니다.
기타 정보는 Product Library 디스크의 사용 설명서(B)를 참조하십시오.
- NL** In deze handleiding (A) worden alleen de basisfuncties van de machine beschreven.
Voor meer informatie, raadpleeg de gebruikershandleiding (B) op de Product Library schijf.
- NO** Denne guide (A) forklarer bare den grunnleggende bruken av maskinen.
For annen informasjon, se Operatørhåndbok (B) i Product Library platen.

- PL** Niniejszy podręcznik (A) objaśnia jedynie podstawowe sposoby używania urządzenia. Więcej informacji można znaleźć w Podręczniku Obsługi (B) lub na dysku Product Library.
- PT-BR** Este guia (A) somente explica as operações básicas da máquina. Para obter outras informações, consulte o Guia de Operação (B) no disco Product Library.
- PT-PT** Este guia (A) explica apenas as operações básicas da máquina. Para obter mais informações, consulte o Guia de Operação (B) no disco Product Library.
- RO** Acest ghid (A) explică doar operațiunile de bază ale aparatului. Pentru alte informații, consultați Ghidul de Operare (B) de pe discul Product Library.
- RU** В данном руководстве (A) описаны только основные операции с устройством. Дополнительные сведения см. в руководстве по эксплуатации (B) на диске Product Library.
- SV** I den här guiden (A) förklaras endast maskinens grundfunktioner. För annan information hänvisas till bruksanvisningen (B) på skivan Product Library.
- TH** คู่มือนี้ (A) อธิบายการทำงานเบื้องต้นของเครื่องพิมพ์เท่านั้น สำหรับข้อมูลเพิ่มเติม โปรดดูคู่มือ (B) ในดิสก์ Product Library
- TR** Bu kılavuz (A) sadece makinenin temel işlemlerini açıklar. Diğer bilgiler için, Product Library diskindeki Çalıştırma Kılavuzuna (B) bakınız.
- VI** Phần hướng dẫn (A) này chỉ giải thích vận hành cơ bản của máy. Để có thêm những thông tin khác, xem Hướng Dẫn Vận Hành (B) trên đĩa Product Library.
- ZH-CN** 本手册 (A) 仅介绍机器的基本操作。有关其他信息，请参阅 Product Library 光盘上的操作手册 (B)。
- ZH-TW** 本手冊 (A) 僅介紹機器的基本操作。有關其他資訊，請參閱 Product Library 光碟上的操作手冊 (B)。
- AR** هذا الدليل (A) يشرح فقط عمليات تشغيل الجهاز الأساسية. لمزيد من المعلومات، راجع دليل التشغيل (B) الموجود على قرص Product Library.

Environment

TASKalfa 2321 / TASKalfa 2021



10 - 32.5 °C (50 to 90 °F)



10 - 80%RH



220-240V ~ 50/60 Hz 6.3 A

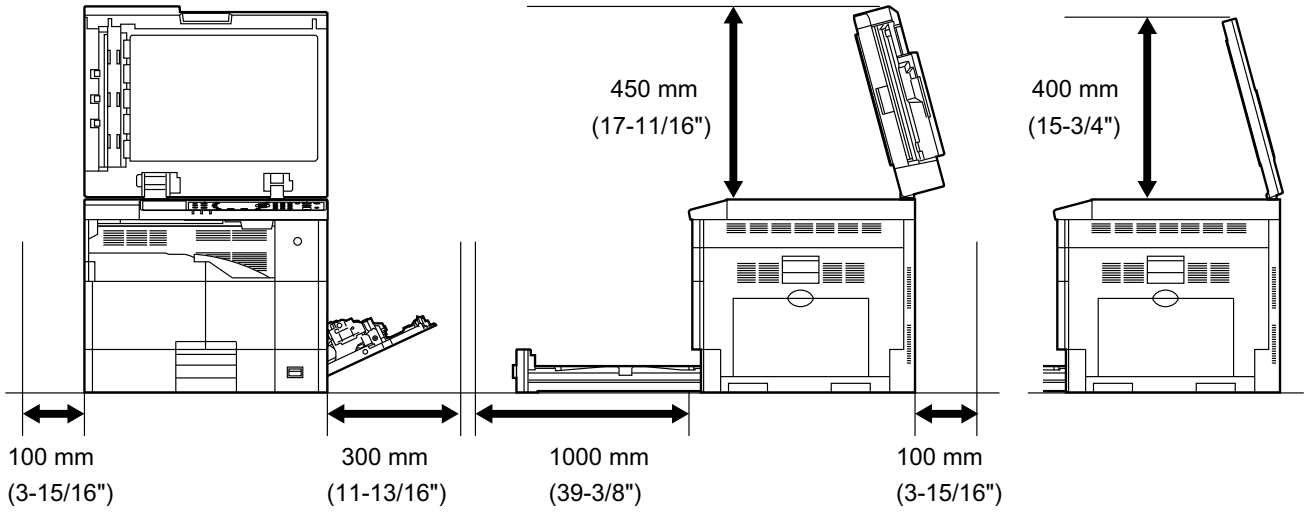

- EN** Environment
CAUTION: Be sure to provide enough space around the machine. Prolonged use without sufficient clearance may cause heat to build up inside the machine, resulting in fire.
- CS** Okolní prostředí
UPOZORNĚNÍ: Dbejte na to, aby kolem tiskárny byl dostatek volného místa. Nebude-li kolem tiskárny dostatek volného místa, může delší používání způsobit hromadění tepla v tiskárně, což může způsobit požár.
- DA** Miljø
FORSIGTIG: Sørg for, at der er tilstrækkelig plads omkring printeren. Langvarig brug uden tilstrækkelig afstand kan medføre opvarmning inden i printeren, hvilket kan resultere i brand.
- DE** Umweltbedingungen
ACHTUNG: Stellen Sie sicher, dass der Drucker über ausreichend Platz verfügt. Dauerhafte Benutzung ohne ausreichenden Platz führt zu mangelnder Belüftung, wodurch Feuer entstehen kann.
- EL** Άνοιγμα
ΠΡΟΣΟΧΗ: Να αφήνετε αρκετό ελεύθερο χώρο γύρω από τον εκτυπωτή. Η παρατεταμένη χρήση χωρίς το απαιτούμενο άνοιγμα μπορεί να έχει ως αποτέλεσμα να συσσωρευτεί θερμότητα εντός του εκτυπωτή και να προκληθεί πυρκαγιά.
- ES** Entorno
PRECAUCIÓN: Asegúrese de dejar espacio suficiente alrededor de la impresora. Si la impresora se utiliza de forma prolongada en un lugar donde el espacio es insuficiente, podría calentarse demasiado y provocar un incendio.
- FI** Ympäristö
VAROITUS: Varmista, että tulostimen ympärillä on riittävästi tilaa. Pitkään jatkunut käyttö ilman riittävää väliä saattaa aiheuttaa lämmön kerääntymistä tulostimen sisälle ja tulipalon.
- FR** Environnement
ATTENTION: veillez à laisser suffisamment d'espace autour de l'imprimante. Une utilisation prolongée sans espace suffisant peut entraîner une surchauffe à l'intérieur de l'imprimante et un risque d'incendie.
- HU** Térköz
FIGYELEM: Ügyeljen rá, hogy legyen elegendő hely a nyomtató körül. Ha a nyomtatót huzamosabb ideig úgy használja, hogy nincs elegendő hely körülötte, a nyomtató felmelegedhet és kigyulladhat.
- IT** Ambiente operativo
ATTENZIONE: Verificare che attorno alla stampante vi sia spazio sufficiente. L'utilizzo prolungato senza spazio libero sufficiente può provocare il surriscaldamento interno della stampante con conseguente pericolo di incendio.
- KO** 환경
주의: 기기 주변에 충분한 공간을 확보해야 합니다. 충분한 여유 공간 없이 장기간 사용할 경우 기기 내부의 온도가 상승해 화재가 발생할 수 있습니다.
- NL** Omgeving
OPGELET: Zorg dat er voldoende ruimte rond de printer is. Langdurig gebruik zonder voldoende ruimte kan ertoe leiden dat de printer binnenin opwarmt, wat brand kan veroorzaken.
- NO** Miljø
FORSIKTIG: Pass på at det er nok plass rundt skriveren. Forlenget bruk med utilstrekkelig klaring kan føre til at det blir veldig varmt inni skriveren og det kan oppstå brann.

- PL** Środowisko robocze
OSTROŻNIE: Należy zapewnić wystarczająco dużo wolnej przestrzeni wokół drukarki. Zbyt długie korzystanie z drukarki bez zapewnienia wystarczającej przestrzeni może skutkować powstaniem wysokiej temperatury wewnątrz drukarki i spowodować pożar.
- PT-BR** Ambiente
CUIDADO: Certifique-se de providenciar o espaço suficiente ao redor da impressora. A utilização prolongada sem um espaço suficiente pode causar acúmulo de calor no interior da impressora, podendo resultar em fogo.
- PT-PT** Ambiente
ATENÇÃO: Assegure-se de que dispõe de espaço suficiente à volta da impressora. O uso prolongado sem espaço livre pode causar o desenvolvimento de calor no interior da impressora, resultando em incêndio.
- RO** Mediul de lucru
ATENȚIE: Alocați suficient spațiu liber în jurul imprimantei. Utilizarea îndelungată în condiții de spațiu liber insuficient poate duce la acumularea de căldură în interiorul imprimantei, având ca rezultat declanșarea unui incendiu.
- RU** Окружающая среда
ВНИМАНИЕ! Вокруг принтера должно быть достаточно свободного пространства. Длительное использование без надлежащей чистки может стать причиной перегрева внутри принтера, что приведет к возгоранию.
- SV** Omgivning
FÖRSIKTIGHET! Se till att det finns tillräckligt med fritt utrymme runt skrivaren. Användning under lång tid utan tillräckligt med fritt utrymme runt skrivaren kan göra att det alstras värme i skrivaren vilket kan ge upphov till brand.
- TH** สิ่งแวดล้อม
ข้อควรระวัง: ตรวจสอบให้แน่ใจว่าเหลือพื้นที่ว่างรอบตัวเครื่องอย่างเพียงพอ การใช้งานโดยไม่มีพื้นที่ว่างมากพอเป็นเวลานาน อาจทำให้เกิดความร้อนสะสมภายในตัวเครื่อง อาจส่งผลให้เกิดไฟไหม้ได้
- TR** Ortam
DİKKAT: Yazıcı etrafında yeterli boş alan bıraktığınızdan emin olun. Yeterli boşluk olmadan uzun süreli kullanım yazıcının içindeki ısının artmasına, dolayısıyla yangına yol açabilir.
- VI** Môi trường lắp đặt
CẢNH BÁO: Đảm bảo cung cấp đủ không gian xung quanh máy. Nếu sử dụng trong thời gian dài nhưng không lắp đặt máy trong một không gian thích hợp, có thể tạo ra nhiệt bên trong máy, và sẽ là nguyên nhân gây ra cháy nổ.
- ZH-CN** 环境
小心: 机器四周应务必留出足够的空间。在未留出足够空间的情况下长时间使用机器可能会导致机器过热, 引起火灾。
- ZH-TW** 環境
小心: 請務必在機器周圍留出足夠的空間。在沒有足夠間隔的情況下長時間使用機器將會引起機器內部過熱, 從而導致火災。
- AR** البيئة
تنبيه: تحقق من ترك مسافة كافية حول الطابعة. الاستخدام لفترة طويلة دون ترك مسافة كافية قد يتسبب في ارتفاع درجة الحرارة داخل الطابعة، الأمر الذي قد يتسبب في نشوب حريق.

A Install Drivers and Utilities

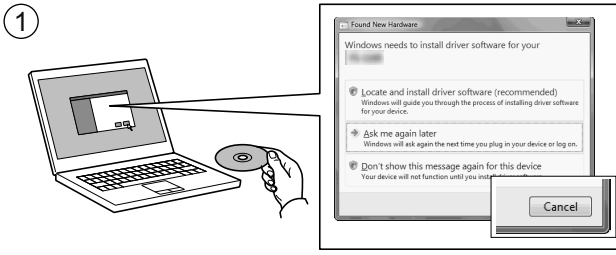

- EN** If Found new Hardware window appears, click Cancel.
- CS** Pokud se zobrazí dialogové okno Nalezen nový hardware, klepněte na tlačítko Storno.
- DA** Vælg Annuller, hvis dialogboksen Der er fundet ny hardware.
- DE** Bitte legen Sie die beiliegende CD ein und folgen Sie den Anweisungen am Bildschirm, falls auf dem Bildschirm die Anzeige 'Neue Hardware gefunden' von Windows erscheint, drücken Sie Abbrechen.
- EL** Αν εμφανιστεί το παράθυρο Εύρεση νέου υλικού, κάντε κλικ στο κουμπί Άκυρο.
- ES** Si aparece la ventana Nuevo hardware encontrado, haga clic en Cancelar.
- FI** Jos näkyyiin tulee Uusi laite löydetty -ikkuna, napsauta Peruuta.
- FR** Si la fenêtre Nouveau matériel détecté s'affiche, cliquez sur Annuler.
- HU** Ha az Új hardver telepítése ablak megjelenik, kattintson a Mégse gombra.
- IT** Se compare la finestra Trovato nuovo hardware, fare clic su Annulla.
- KO** '새 하드웨어 발견' 창이 나타나면 취소를 클릭합니다.
- NL** Als het dialogvenster nieuwe hardware gevonden verschijnt, selecteert u Annuleren.
- NO** Hvis vinduet Ny maskinvare funnet vises, klikk på Avbryt.
- PL** Jeżeli wyświetlone zostanie okno Znaleziono nowy sprzęt, należy kliknąć przycisk Anuluj.
- PT-BR** Se a janela Um novo Hardware foi encontrado aparecer, clique em Cancelar.
- PT-PT** Se a janela Encontrar Novo Hardware aparecer, clique em Cancelar.
- RO** Dacă apare fereastra Found New Hardware, faceți clic pe Cancel.
- RU** Если появляется окно Найдено новое аппаратное обеспечение, щелкните Отменить.
- SV** Om Dialogfönstret visar 'Hittade ny hårdvara' klicka då på Avbryt.
- TH** หากหน้าต่าง Found new Hardware ปรากฏขึ้นคลิก Cancel
- TR** Yeni Donanım Bulundu penceresi görüntülenirse, İptal'i tıklatın.
- VI** Bấm Hủy bỏ khi xuất hiện cửa sổ Found New Hardware.
- ZH-CN** 如果出现找到新的硬件窗口，请单击取消。
- ZH-TW** 如果出現找到新硬體視窗，請按一下取消。
- AR** إذا ظهرت نافذة تم العثور على جهاز جديد ، انقر على إلغاء.

2

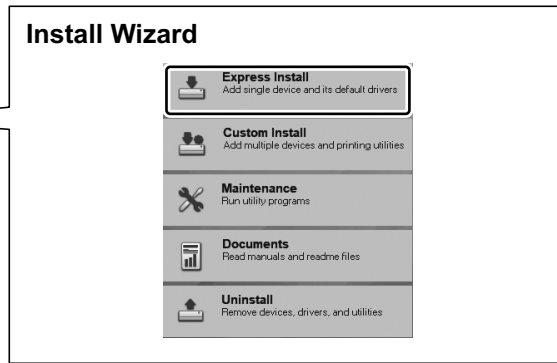
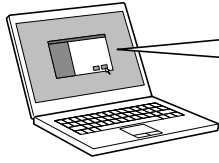

- EN** Follow the instructions in the installation wizard.
- CS** Řiďte se pokyny v průvodci instalací.
- DA** Følg instruktionerne i installationsguiden.
- DE** Folgen Sie den Anweisungen des Schnelleinstellung Assistenten.
- EL** Ακολουθήστε τις οδηγίες στον οδηγό εγκατάστασης.
- ES** Siga las instrucciones del asistente de instalación.
- FI** Noudata asennusohjelman ohjeita.
- FR** Suivre les instructions de l'assistant d'installation.
- HU** Kövesse a telepítő varázsló utasításait.
- IT** Attenersi alle istruzioni della procedura guidata di installazione.
- KO** 설치 마법사의 지침에 따르십시오.
- NL** Volg de instructies in de installatiewizard.
- NO** Følg instruksjonene i installasjonsveiledningen.
- PL** Postępuj zgodnie z instrukcjami wyświetlanymi w oknie kreatora instalacji.
- PT-BR** Siga as instruções no assistente de instalação.
- PT-PT** Siga as instruções no assistente de instalação.
- RO** Urmați instrucțiunile expertului de instalare.
- RU** Следуйте инструкциям в окне мастера установки.
- SV** Följ anvisningarna i installationsguiden.
- TH** ทำตามคำแนะนำในตัวช่วยการติดตั้ง
- TR** Kurulum sihirbazındaki talimatları izleyiniz.
- VI** Thực hiện theo các hướng dẫn trong mục installation wizard.
- ZH-CN** 遵循安装向导中的说明。
- ZH-TW** 遵循安裝精靈中的說明。
- AR**

اتبع تعليمات معالج التنبيت.

B Login

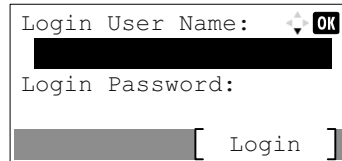

EN Login User Name: Admin
Login Password: Admin

PL Nazwa logowania: Admin
Hasło logowania: Admin

CS Přihl.uživ.jméno: Admin
Přihl. Heslo: Admin

PT-BR Usuário login: Admin
Senha de login: Admin

DA Login brugernavn: Admin
Login adg.kode: Admin

PT-PT N.Util.Iníc.Ses.: Admin
P.pass.Iníc.Ses.: Admin

DE Login-Name: Admin
Login-Password: Admin

RO Nume utilizator: Admin
Parolă Conectare: Admin

EL Σύνδ./Ον. Χρήστη: Admin
Κωδ.Πρόσβ.Σύνδ.: Admin

RU Имя польз. д/вх.: Admin
Пароль при входе: Admin

ES Nom. us. in. ses: Admin
Contr. in. ses.: Admin

SV Användarnamn: Admin
Inloggn.lösenord: Admin

FI Kirj. Käytt.nimi: Admin
Kirj. salasana: Admin

TH ชื่อผู้ใช้: Admin
รหัสผ่านล็อกอิน: Admin

FR Login nom utilis: Admin
Login mot passe: Admin

TR O. Açma Kul. Adı: Admin
O. Açma Parolası: Admin

HU Bej. Felh. név: Admin
Bej. jelszó: Admin

VI Tên người dùng: Admin
Mật khẩu: Admin

IT Nome uten. login: Admin
Password login: Admin

ZH-CN 登录用户名: Admin
登录密码: Admin

KO 로그인 사용자명: Admin
로그인 패스워드: Admin

ZH-TW 登錄使用者名稱: Admin
登入密碼: Admin

NL Aanmeld.gebr.nm: Admin
Aanmeld.wachtw.: Admin

AR

اسم الدخول : Admin
كلمة مرور الدخول: Admin

NO Pålogg.brukernvn: Admin
Passord: Admin

C Cancel Printing

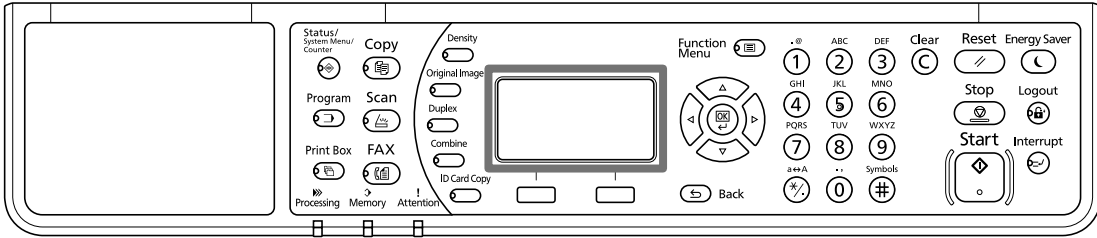
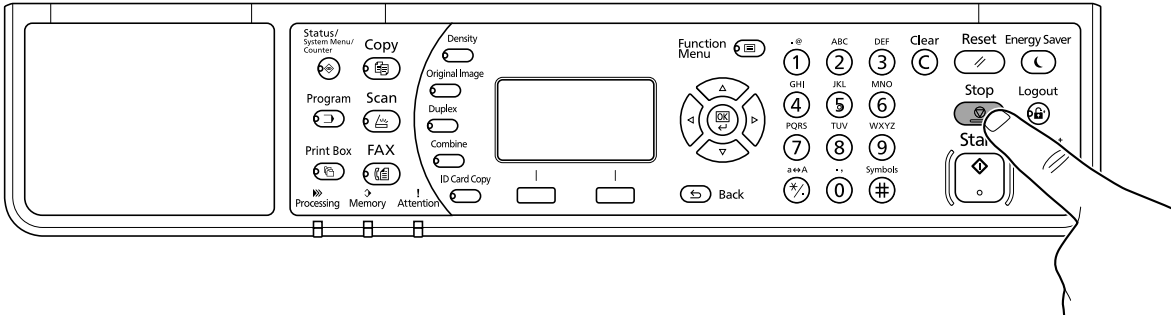

EN

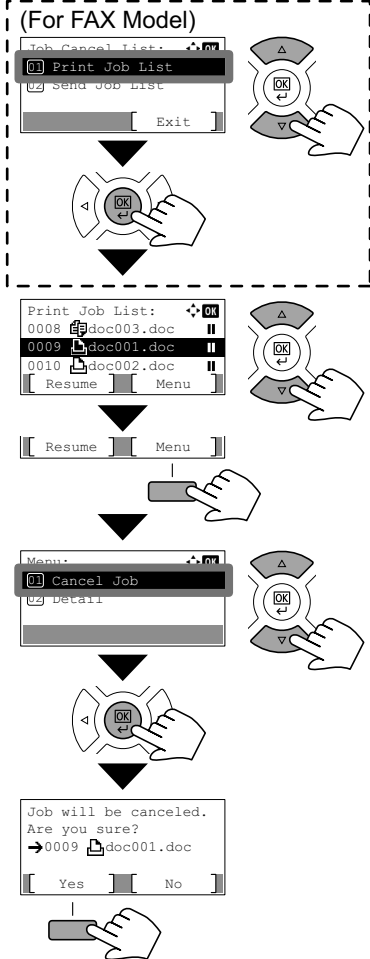

CS

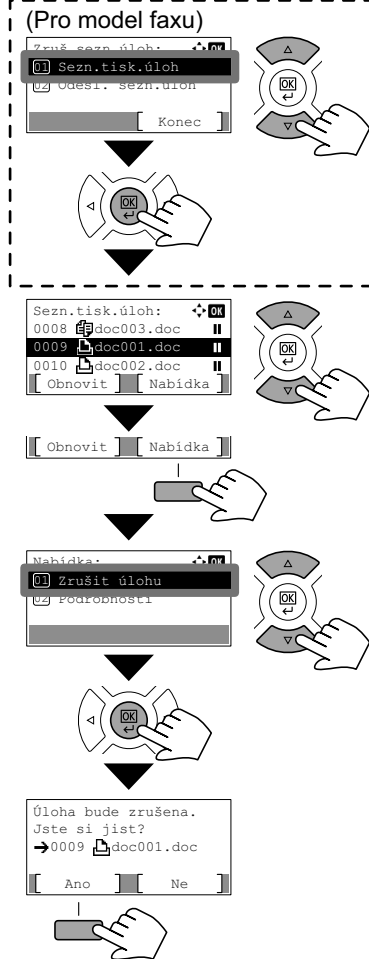

DA

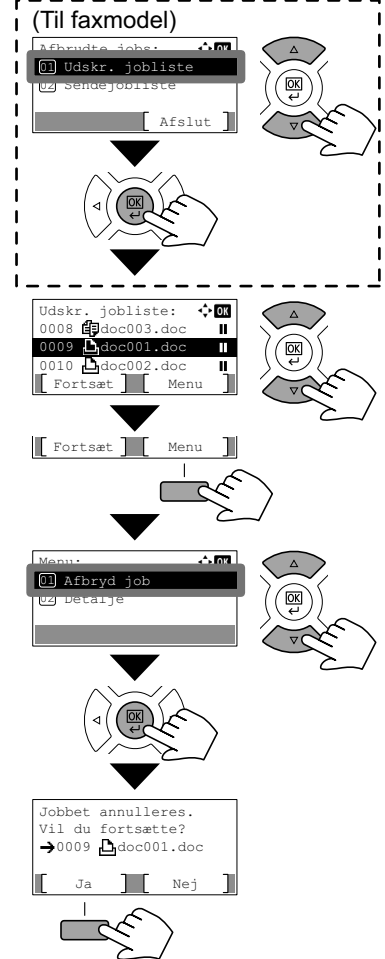

DE

(Für das FAX-Modell)

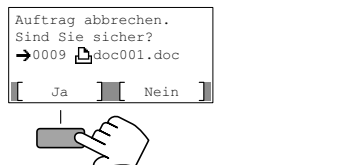
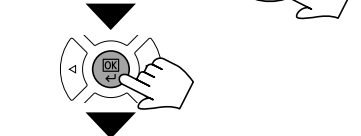
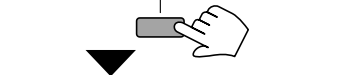
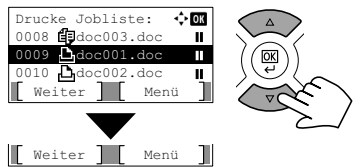
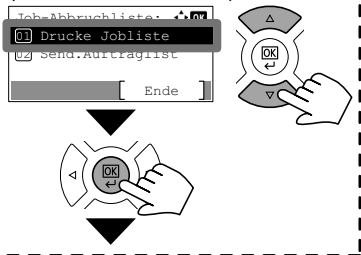

EL

(Για μοντέλο με FAX)

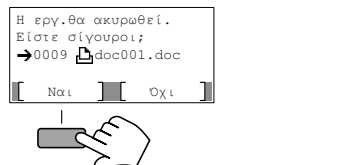
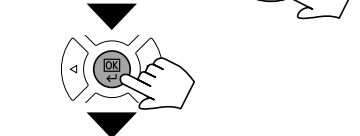
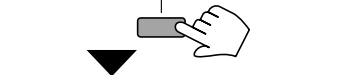
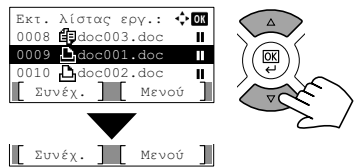
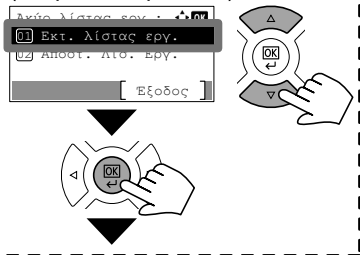

ES

(Para el modelo de FAX)

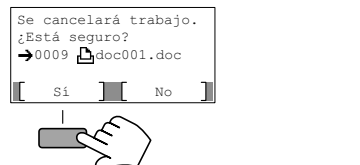
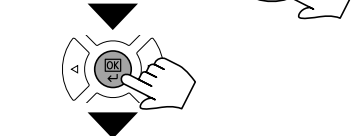
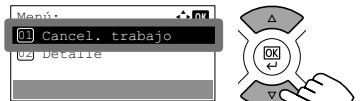
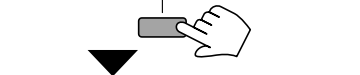
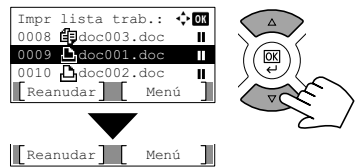
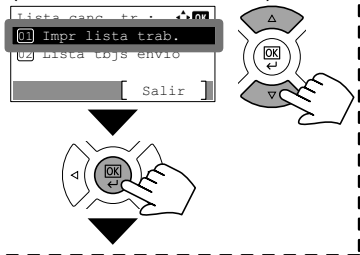

FI

(Faksimalli)

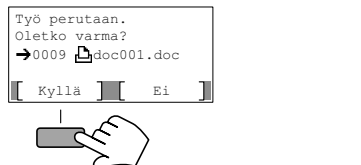
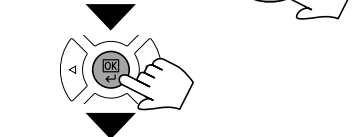
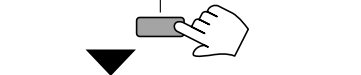
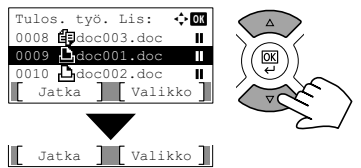
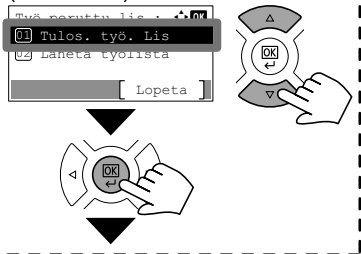

FR

(Pour le modèle de fax)

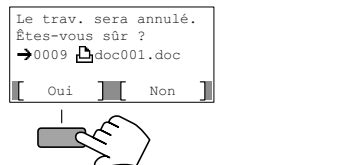
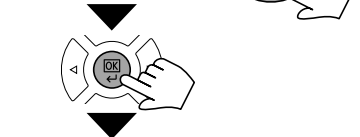
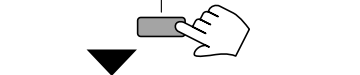
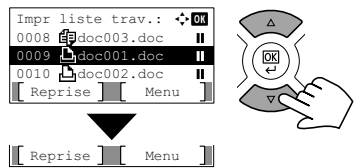
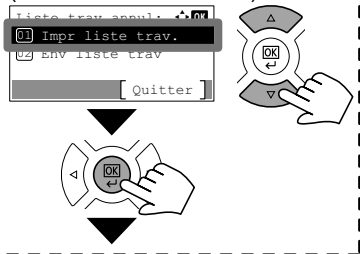

HU

(Fax modell esetén)

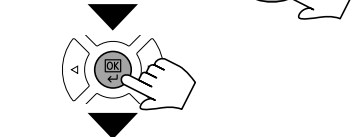
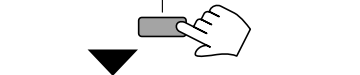
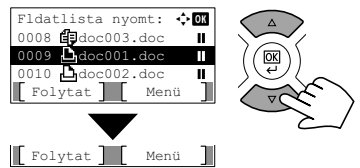
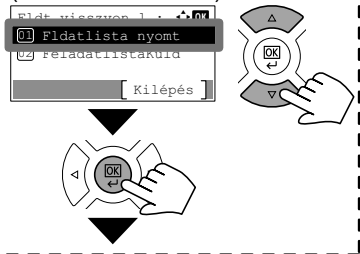

IT

(Per il modello FAX)

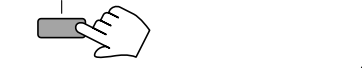
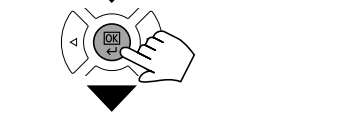
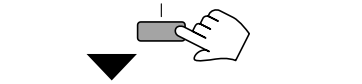
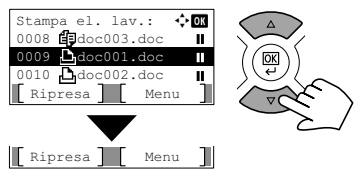
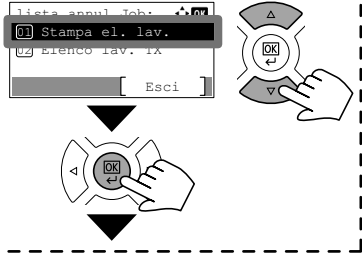

KO

(팩스 모델용)

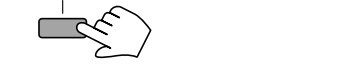
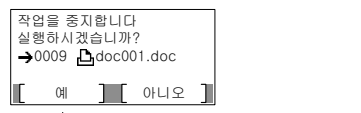
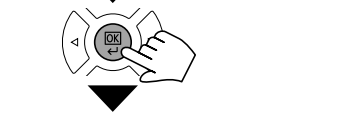
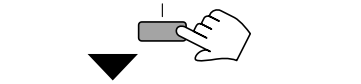
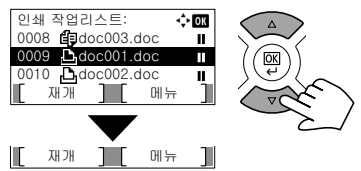
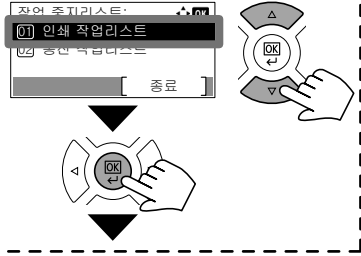

NL

(Voor Fax model)

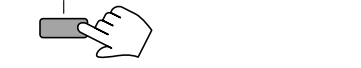
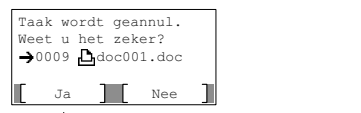
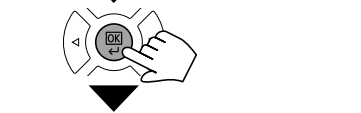
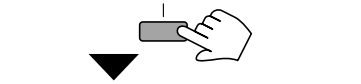
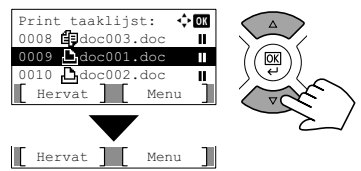
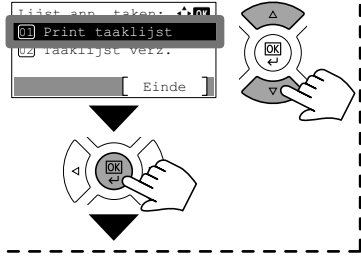

NO

(For faksmodell)

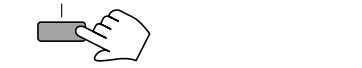
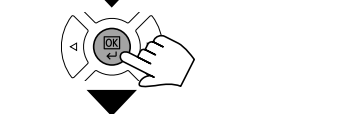
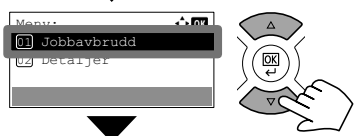
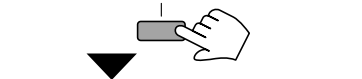
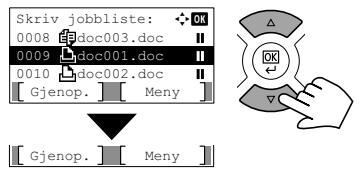
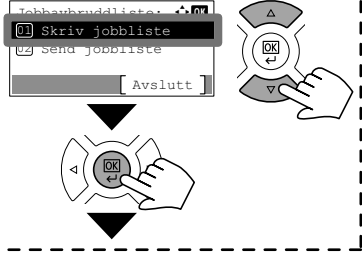

PL

(Dla modelu FAKSU)

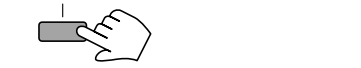
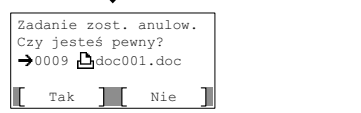
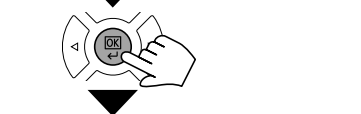
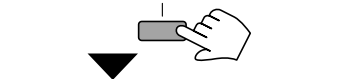
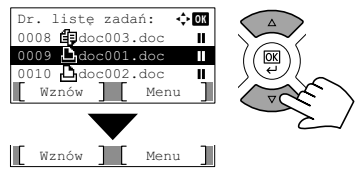
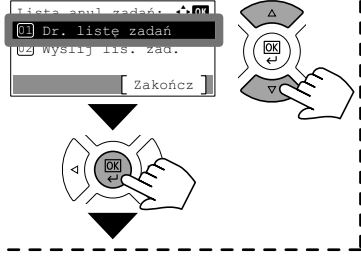

PT-BR

(Para Modelo FAX)

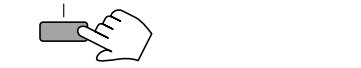
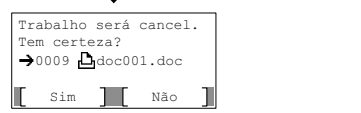
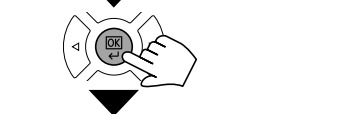
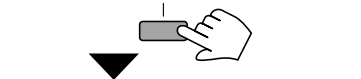
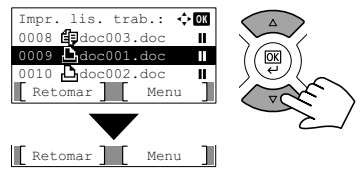
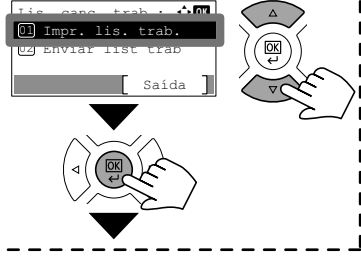

PT-PT

(Para Modelo FAX)

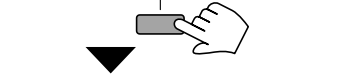
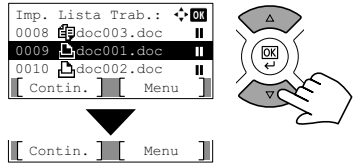
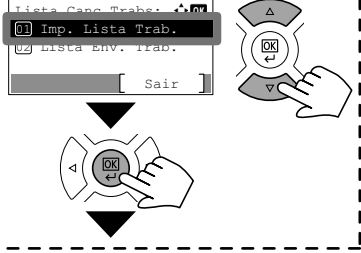

RO

(Pentru model FAX)

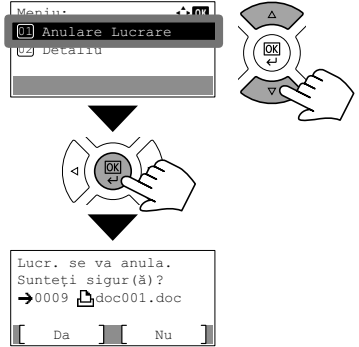
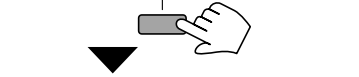
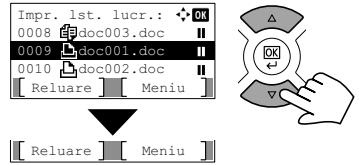
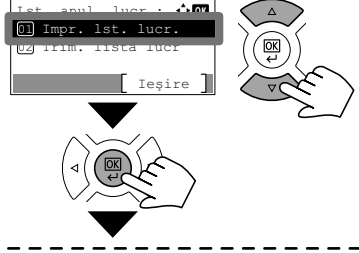

RU

(Для модели факса)

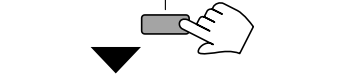
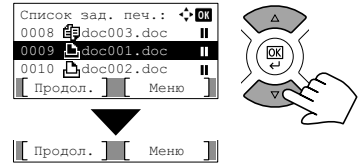
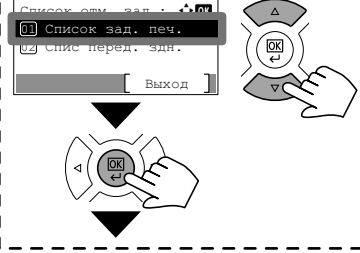

SV

(För fax-modell)

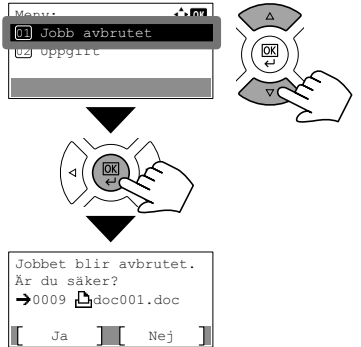
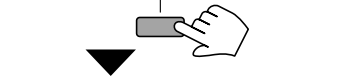
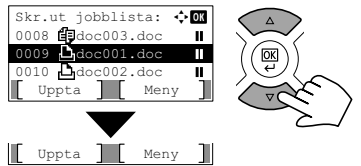
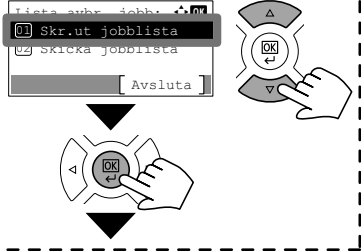

TH

(สำหรับรุ่นแฟกซ์)

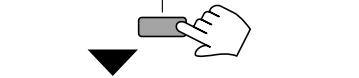
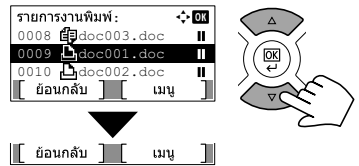
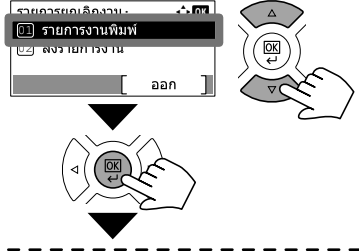

TR

(FAKS modeli için)

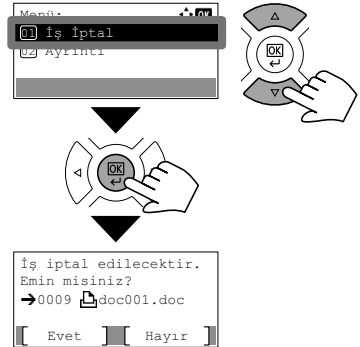
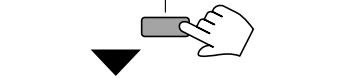
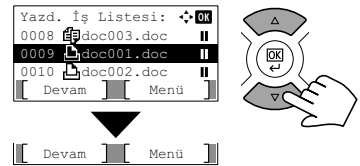
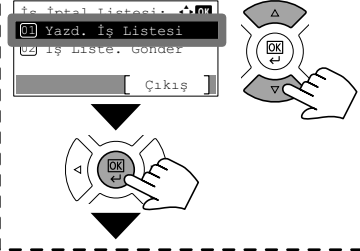

VI

(Đối Với Kiểu FAX)

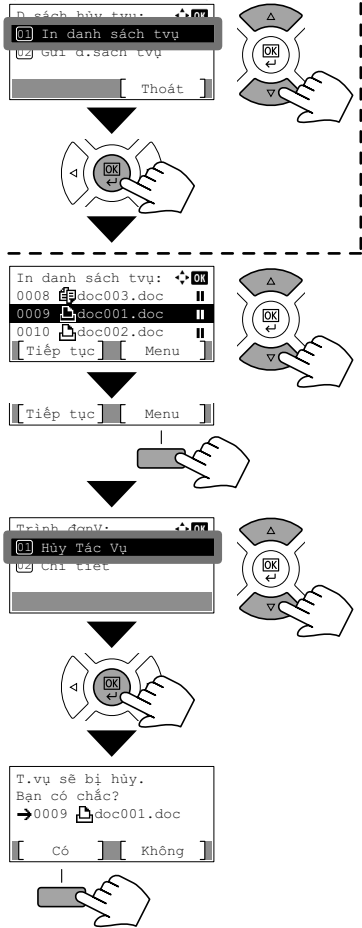

ZH-CN

(适用于传真型号)

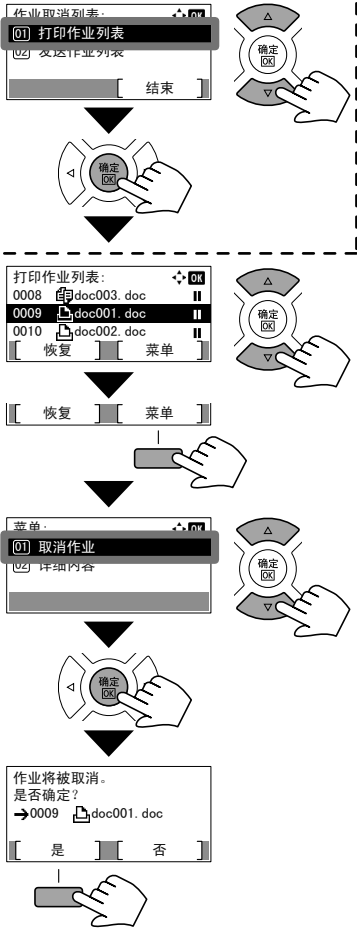

ZH-TW

(適用於傳真機型)

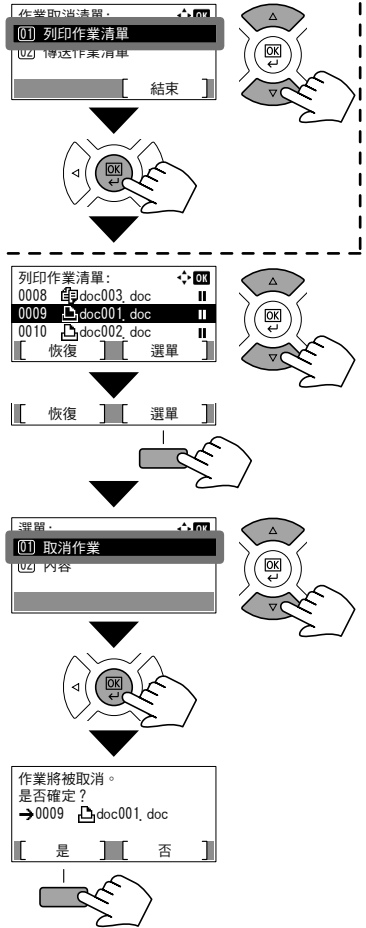

AR

(الفاكس لطراز)

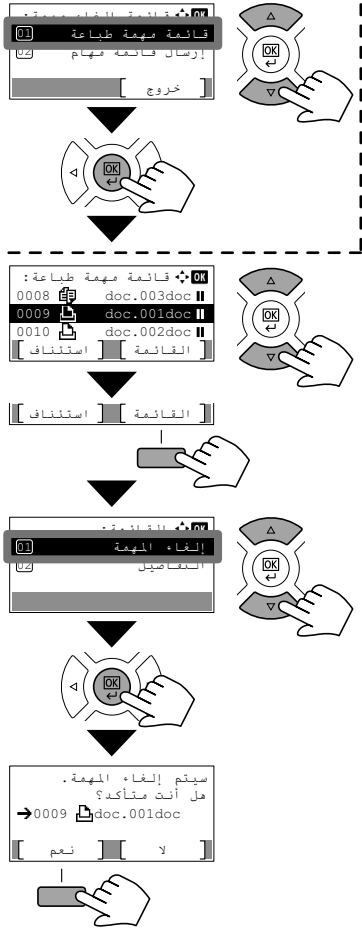

D Copy

①

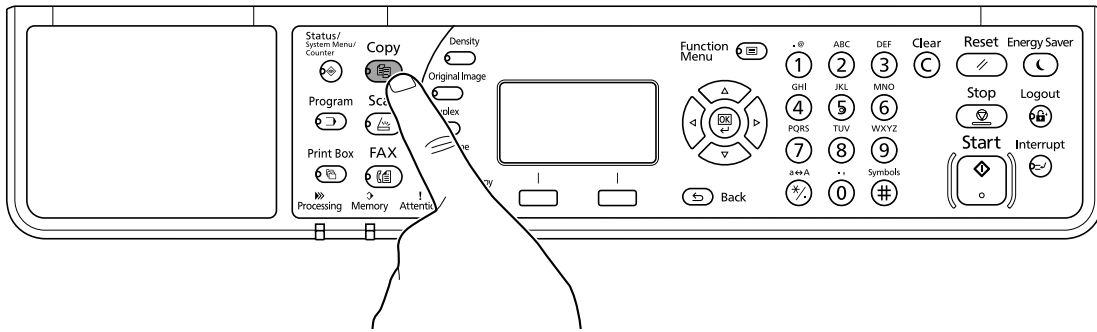

②

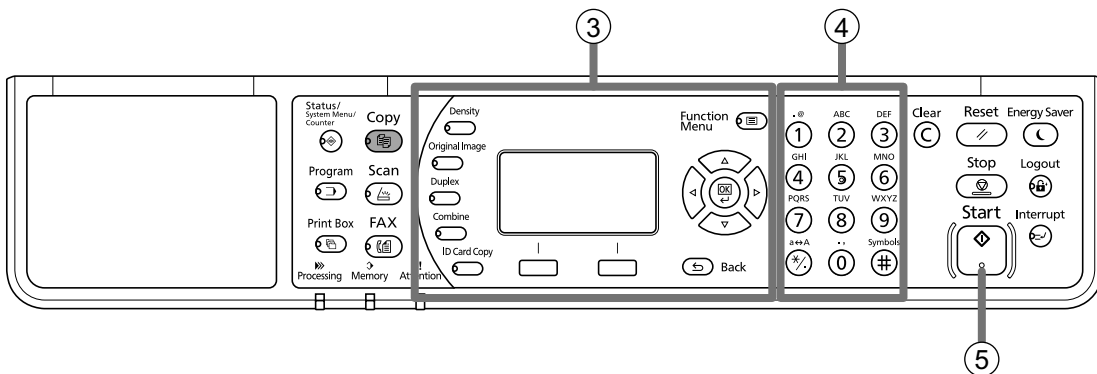
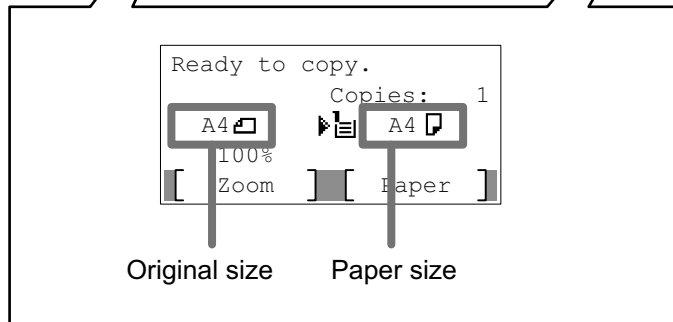
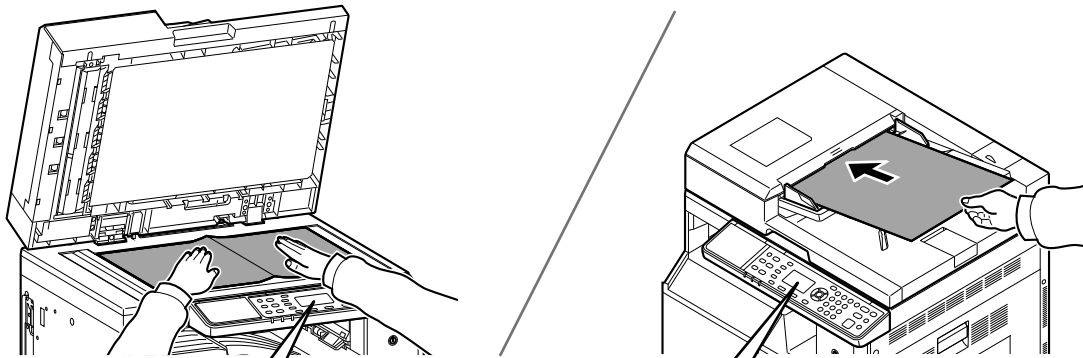

E Scan

1

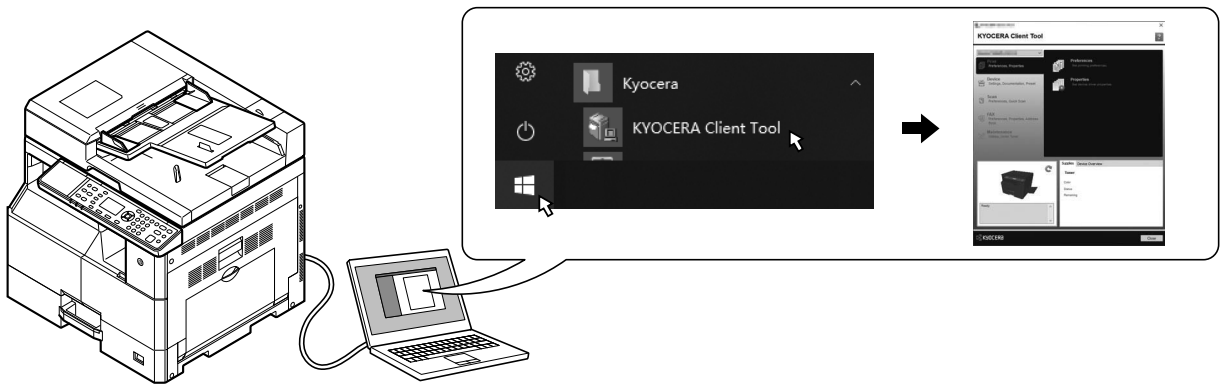

2

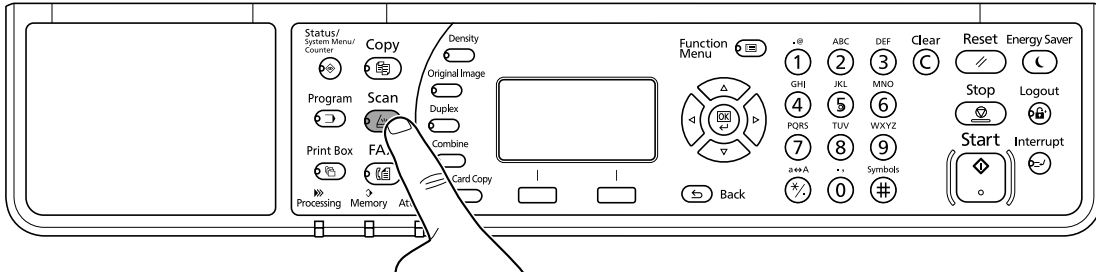

3

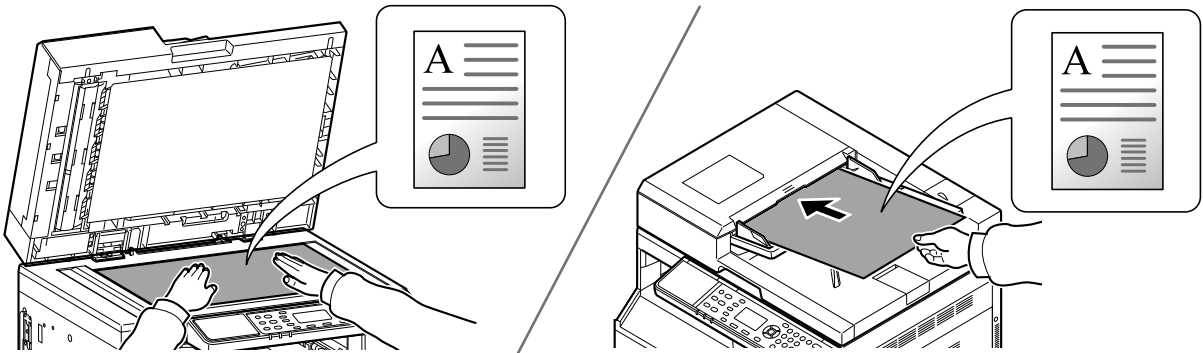

4

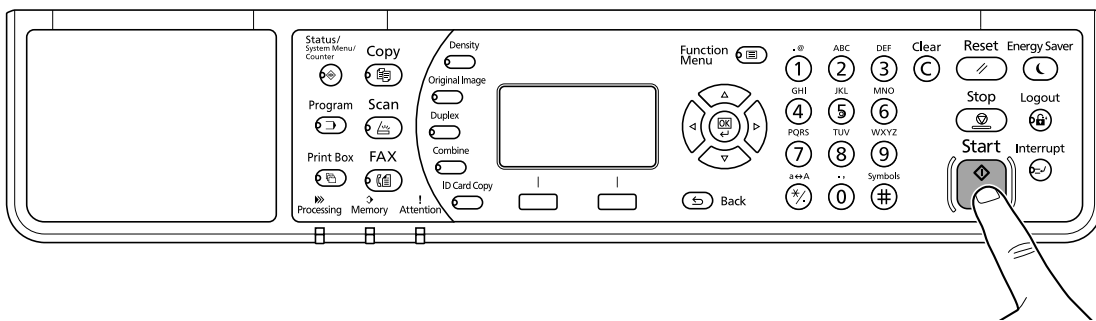

5

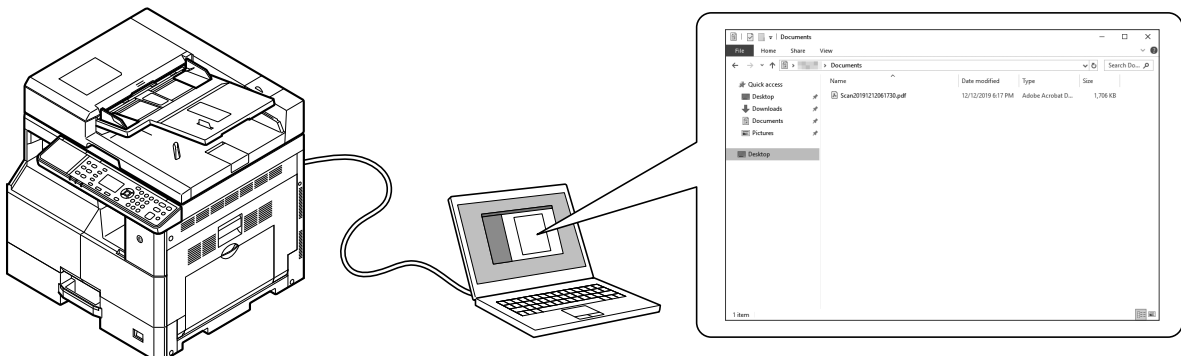

F FAX (Optional)

①

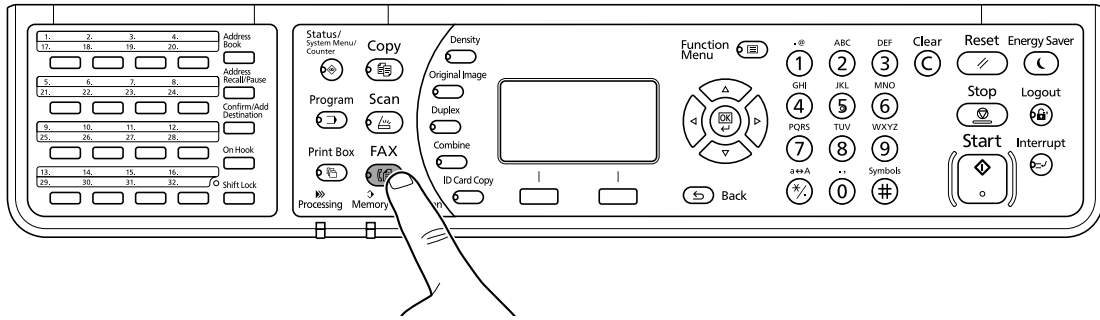



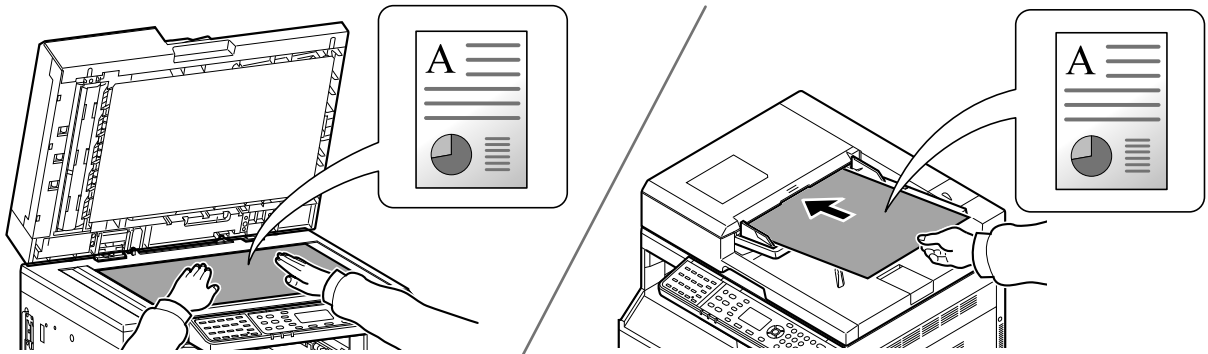

②

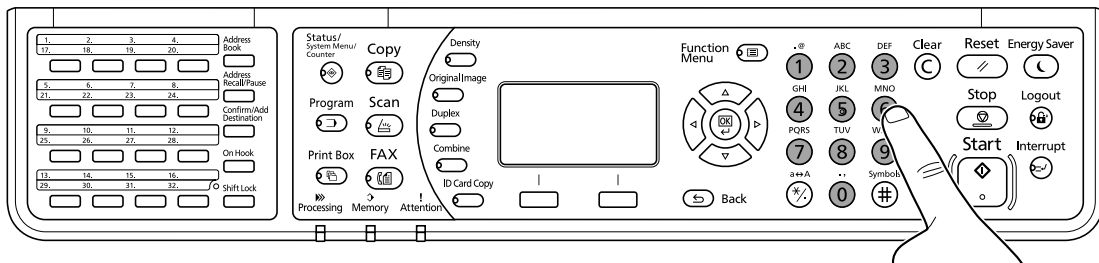

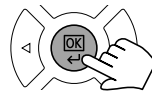
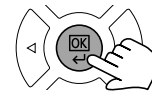
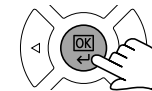
③ FAX No. Entry

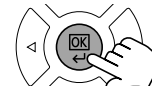

<p>EN</p> <p>FAX No. Entry: 0123456789 <input type="button" value="OK"/></p> <p>[Chain] [Detail]</p> 	<p>CS</p> <p>Zadáni fax. čís.: 0123456789 <input type="button" value="OK"/></p> <p>[Řetěz] [Podrobn.]</p> 	<p>DA</p> <p>Angiv faxnr.: 0123456789 <input type="button" value="OK"/></p> <p>[Kæde] [Detalje]</p> 	<p>DE</p> <p>FAX-Nr.-Eingabe: 0123456789 <input type="button" value="OK"/></p> <p>[Kettenw.] [Detail]</p> 
<p>EL</p> <p>Είσοχ. Αριθ. ΦΑΞ: 0123456789 <input type="button" value="OK"/></p> <p>[Αλυσίδα] [Λεπτομ.]</p> 	<p>ES</p> <p>Ingreso nro. FAX: 0123456789 <input type="button" value="OK"/></p> <p>[Cadena] [Detalle]</p> 	<p>FI</p> <p>Kirjfaxsin nro: 0123456789 <input type="button" value="OK"/></p> <p>[Ketju] [Tiedot]</p> 	<p>FR</p> <p>Entrée N° de FAX: 0123456789 <input type="button" value="OK"/></p> <p>[Chainer] [Détails]</p> 

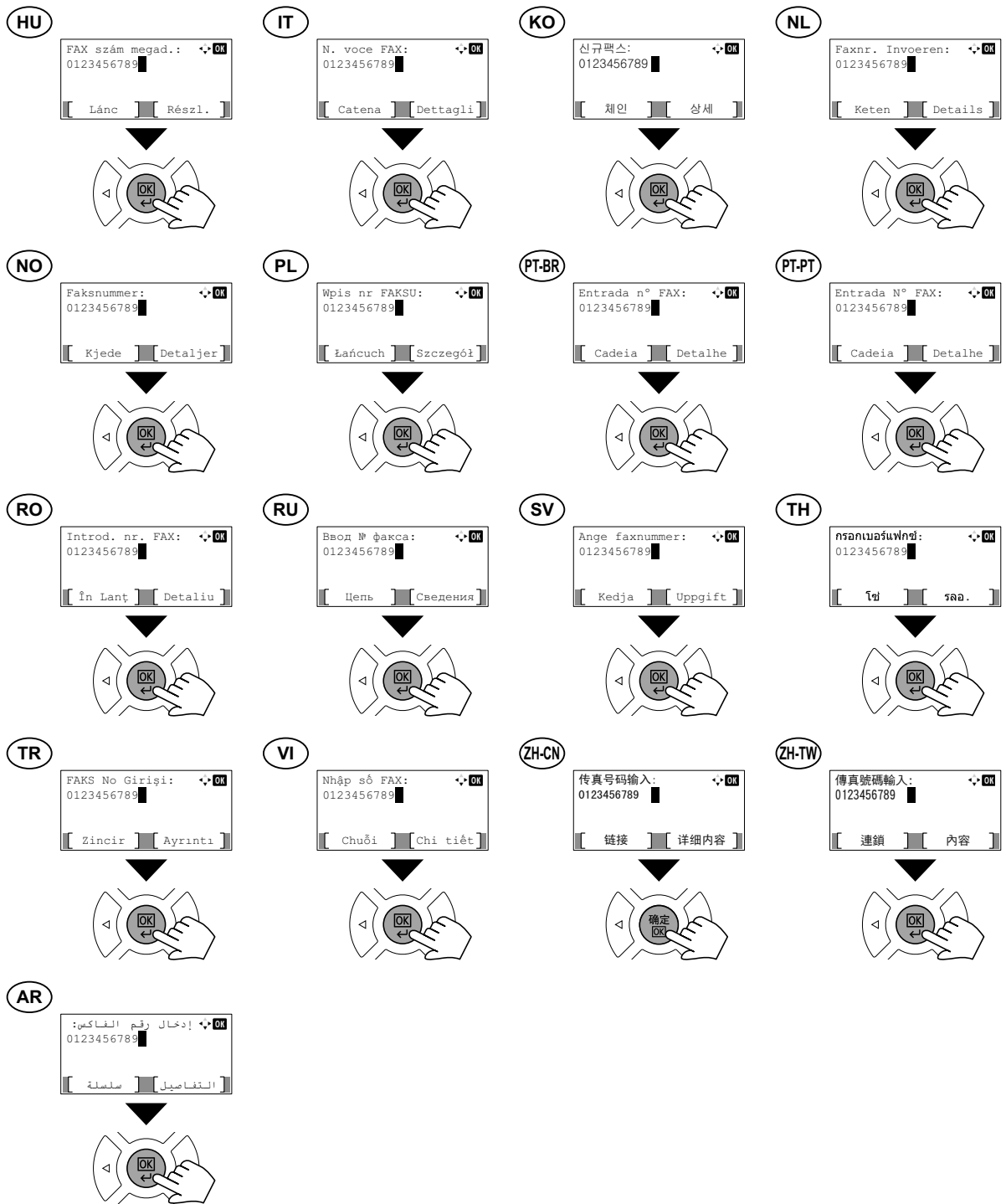

Address Book

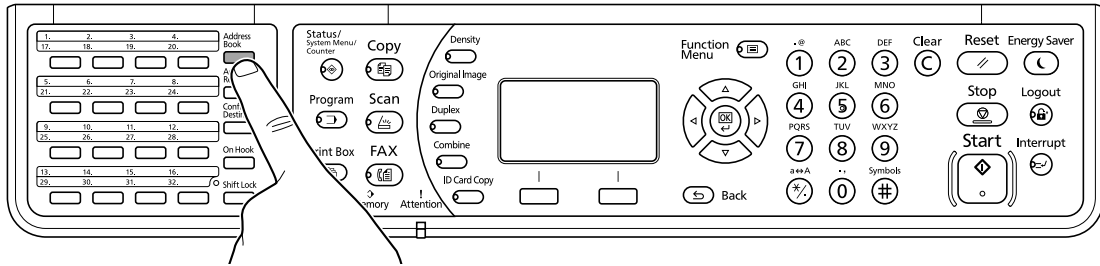

EN

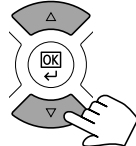
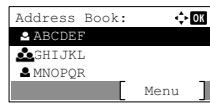

CS

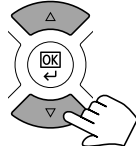
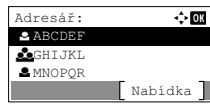

DA

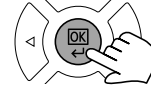
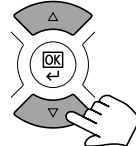
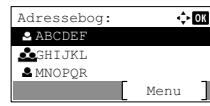

DE

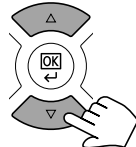
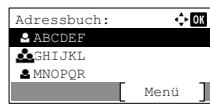

EL

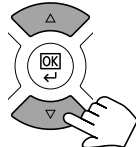
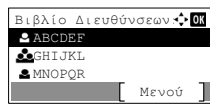

ES

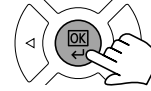
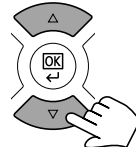
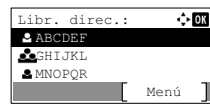

FI

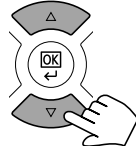
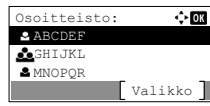

FR

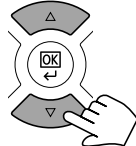
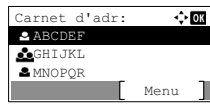

HU

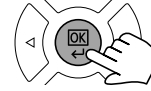
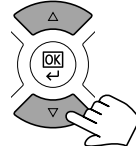
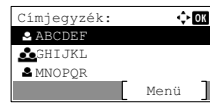

IT

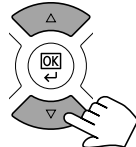
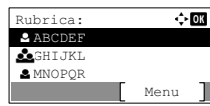

KO

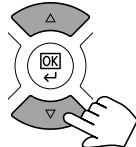
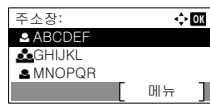

NL

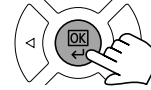
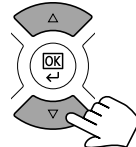
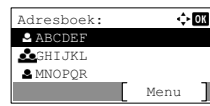

NO

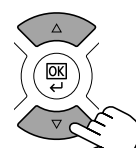
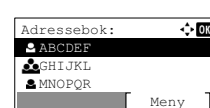

PL

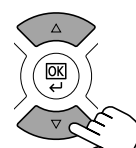
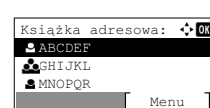

PT-BR

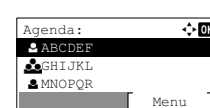

PT-PT

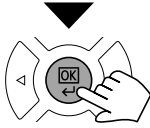
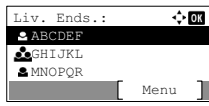

RO

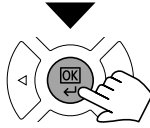
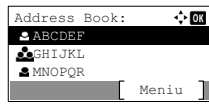

RU

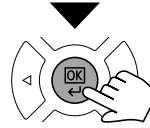
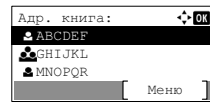

SV

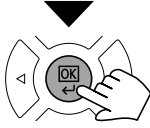
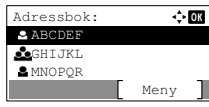

TH

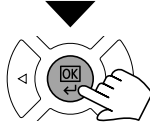
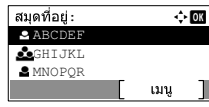

TR

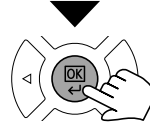
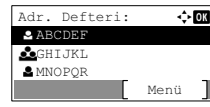

VI

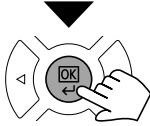
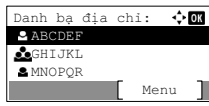

ZH-CN

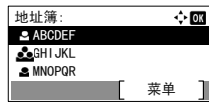

ZH-TW

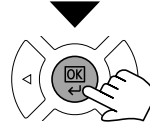
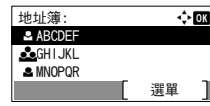

AR

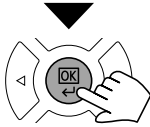
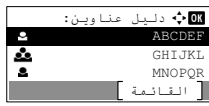

One Touch Key

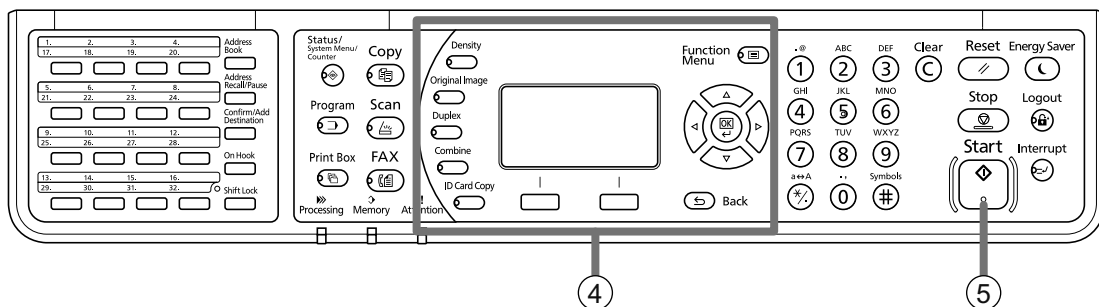
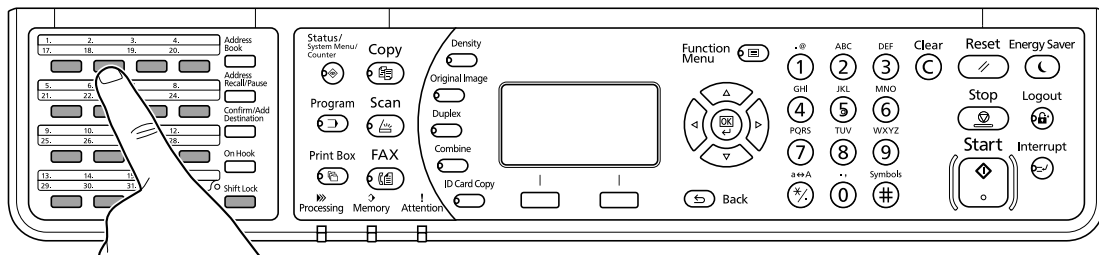

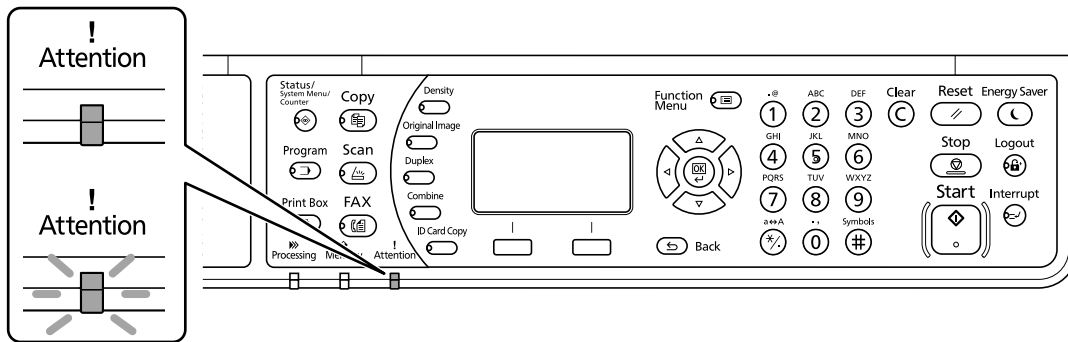

- EN** If an error occurs on the machine, the Attention indicator on the operation panel will light up or flash. Also the error message or the error code appears on the screen. Check the display in KYOCERA Client Tool on the PC and clear the error. For details, refer to the manual on the Product Library disc.
- CS** Pokud přístroj zjistí chybu, rozsvítí se nebo zabliká indikátor Pozor na ovládacím panelu. Také se na obrazovce objeví chybová zpráva nebo kód chyby. Zkontrolujte displej v KYOCERA Client Tool v počítači a odstraňte chybu. Pro podrobnosti nahlédněte do manuálu na disku Product Library.
- DA** Hvis der opstår en fejl på maskinen vil advarselsindikatoren på betjeningspanelet lyse eller blinke. Der vises også fejlmeddelelse eller fejlkode på skærmen. Klik på skærmen i KYOCERA Client Tool på pc'en og afhjælp fejlen. Flere oplysninger findes i manualen på disken Product Library.
- DE** Falls ein Fehler am Gerät auftritt, blinkt oder leuchtet die Warnung Anzeige auf dem Bedienfeld. Zusätzlich erscheint eine Fehlermeldung oder ein Fehlercode in der Anzeige. Überprüfen Sie die Anzeige im KYOCERA Client Tool auf dem PC und löschen Sie den Fehler. Weitere Informationen siehe im Handbuch, das in der auf dem Datenträger vorhandenen Product Library enthalten ist.
- EL** Εάν παρουσιαστεί σφάλμα στο μηχάνημα, θα ανάψει ή θα αναβοσβήσει η ένδειξη Προσοχής στον πίνακα λειτουργίας. Επίσης, το μήνυμα σφάλματος ή ο κωδικός σφάλματος θα εμφανιστεί στην οθόνη. Ελέγξτε τις ενδείξεις στο εργαλείο KYOCERA Client Tool στον υπολογιστή και διαγράψτε το σφάλμα. Για λεπτομέρειες, ανατρέξτε στο εγχειρίδιο στο δίσκο του Product Library.
- ES** Si se produce un error en la máquina, el indicador Atención en el panel de operación se encenderá o parpadeará. El mensaje de error o el código de error también aparece en la pantalla. Verifique la pantalla KYOCERA Client Tool en el computador personal y corrija el error. Para los detalles, refiérase al manual en el disco Product Library.
- FI** Jos koneessa tapahtuu virhe, ohjauspaneelin Huomio-merkkivalo syttyy palamaan tai vilkkuu. Lisäksi näytölle tulee näkyviin virheviesti tai virhekoodi. Tarkista KYOCERA Client Tool -sovelluksen näyttö tietokoneesta ja poista virhe. Lisätietoja on Product Library -levyn käyttöoppaassa.
- FR** Si une erreur se produit sur la machine, le témoin Attention du panneau de commande s'allume ou clignote. Le message d'erreur ou le code d'erreur s'affichent également sur l'écran. Vérifier l'affichage du KYOCERA Client Tool de l'ordinateur et supprimer l'erreur. Pour plus de détails, se reporter au manuel du Product Library disque.
- HU** Ha a készüléken hiba történik, akkor a kezelőpanelen lévő figyelmeztető jelzés világít vagy villog. A kijelzőn egy hibaüzenet vagy a hibakód is megjelenik. A számítógépen ellenőrizze a KYOCERA Client Tool kijelzőjét, és törölje a hibát. Részletekért lásd a Product Library lemezen lévő útmutatót.
- IT** Se si verifica un errore sulla periferica, si accende o lampeggia l'indicatore Attenzione sul pannello di controllo. Inoltre, sulla schermata viene visualizzato un messaggio o un codice di errore. Controllare il display utilizzando KYOCERA Client Tool sul PC e azzerare l'errore. Per i dettagli, consultare il manuale sul disco Product Library.
- KO** 기기에 오류가 발생한 경우 작동 패널의 주의 표시등이 켜지거나 깜박입니다. 또한, 장애 메시지 또는 장애 코드가 화면에 나타납니다. PC에서 KYOCERA Client Tool의 표시 내용을 확인하고 오류를 제거합니다. 자세한 내용은 Product Library 디스크의 설명서를 참조하십시오.
- NL** Als zich een fout voordoet op de machine, zal de indicator voor Attentie op het bedieningspaneel oplichten of knipperen. Ook verschijnt het foutbericht of de foutcode op het scherm. Controleer de display in de KYOCERA Client Tool op de PC en wis de fout. Raadpleeg voor meer informatie de handleiding op de Product Library-schijf.

- NO** Varselindikatoren på driftspanelet lyser og blinker hvis en feil oppstår på maskinen. Feilmeldingen eller feilkoden vises på skjermen. Sjekk displayet i KYOCERA Client Tool på PC-en og tøm feilmeldingen. For detaljer, se manualen på Product Library-disken.
- PL** Jeżeli wystąpi błąd urządzenia, na panelu operacyjnym świeci lub miga wskaźnik Attention. Ponadto na ekranie wyświetlany jest komunikat o błędzie lub kod błędu. Sprawdź wyświetlany komunikat za pomocą narzędzia KYOCERA Client Tool i wyczyść błąd. Aby uzyskać szczegółowe informacje, patrz podręcznik na dysku Product Library.
- PT-BR** Se se produz un erro na máquina, o indicador Atenção no painel de operação acender-se-á ou piscará. A mensagem de erro e o código de erro também aparecem na tela. Verifique a tela KYOCERA Client Tool no computador pessoal e corrija o erro. Para os detalhes, refira-se ao manual no disco Product Library.
- PT-PT** Se ocorrer um erro na máquina, o indicador Attention, no painel de operação, acenderá ou ficará intermitente. Além disso, a mensagem de erro ou o código de erro aparecerá no ecrã. Verifique o ecrã na KYOCERA Client Tool, no PC, e resolva o erro. Para informações, consulte o guia no disco Product Library.
- RO** Dacă apare eroare la imprimantă, indicatorul Attention (Atenție) de pe panoul de operare se va aprinde sau va lumina intermitent. Pe ecran mai apar și mesajul de eroare sau codul erorii. Verificați mesajul afișat în KYOCERA Client Tool la PC și ștergeți eroarea. Pentru detalii, consultați manualul de pe CD-ul Product Library.
- RU** В случае возникновения ошибки аппарата, на панели управления загорится или будет мигать индикатор Внимание. Также сообщение об ошибке или код ошибки появится на экране. Проверьте индикацию в KYOCERA Client Tool на ПК и удалите ошибку. Для получения подробной информации обратитесь к руководству Product Library на диске.
- SV** Om ett fel uppstår på maskinen tänds eller blinkar underhållsindikatorn på manöverpanelen. Även felmeddelande eller felkod visas på skärmen. Kontrollera displayen i KYOCERA Client Tool på datorn och åtgärda felet. För mer information, se anvisningarna på skivan Product Library.
- TH** หากเกิดข้อผิดพลาดขึ้นกับตัวเครื่อง เครื่องหมาย Attention บนแผงควบคุมการทำงานจะสว่างขึ้นหรือกะพริบ ข้อความแสดงข้อผิดพลาดหรือรหัสข้อผิดพลาดยังปรากฏบนหน้าจออีกด้วย ตรวจสอบจอแสดงผลใน KYOCERA Client Tool บนเครื่องพีซี และแก้ไขข้อผิดพลาดนั้น สำหรับรายละเอียด ให้ดูคู่มือในแผ่นดิสก์ Product Library
- TR** Makinede bir hata meydana gelirse, işletim panelindeki Dikkat göstergesi yanar veya yanıp söner. Aynı zamanda ekranda hata mesajı veya hata kodu görünür. Bilgisayarda KYOCERA Client Tool göstergesini kontrol edin ve hatayı giderin. Ayrıntılar için Product Library diskindeki kılavuza başvurun.
- VI** Nếu lỗi xuất hiện trên máy, đèn báo Attention trên bảng thao tác sẽ sáng lên hoặc chớp sáng. Thông điệp lỗi và mã lỗi xuất hiện trên màn hình. Kiểm tra hiển thị trong KYOCERA Client Tool trên PC và xóa lỗi. Để biết thêm chi tiết, vui lòng tham khảo tài liệu hướng dẫn trong đĩa Product Library.
- ZH-CN** 如果机器出现错误，则操作面板上的注意指示灯会亮起或者闪烁。同时，画面显示错误信息或错误代码。请检查PC上KYOCERA Client Tool中的显示信息并清除错误。有关更多信息，请参阅Product Library光盘中的指南。
- ZH-TW** 如果機器出現錯誤，則操作面板上的注意指示燈會亮起或者閃爍。同時，畫面顯示錯誤訊息或者錯誤代碼。請檢查電腦上KYOCERA Client Tool中的顯示資訊並清除錯誤。有關詳細資訊，請參閱Product Library光碟中的指南。
- AR** إذا حدث أي خطأ في الآلة، سيضيء أو يومض المؤشر انتباه الموجود على لوحة التشغيل. وكذلك تظهر رسالة الخطأ أو كود الخطأ على الشاشة. تفقد شاشة العرض في KYOCERA Client Tool على جهاز الكمبيوتر الشخصي وامسح الخطأ. للتعويض، راجع الدليل الموجود على اسطوانة Product Library.

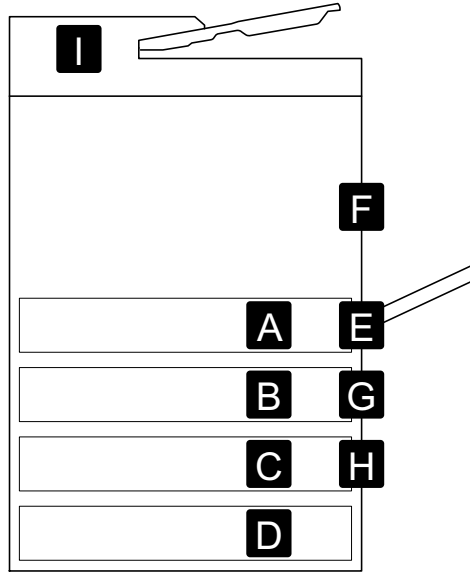
**A**

①

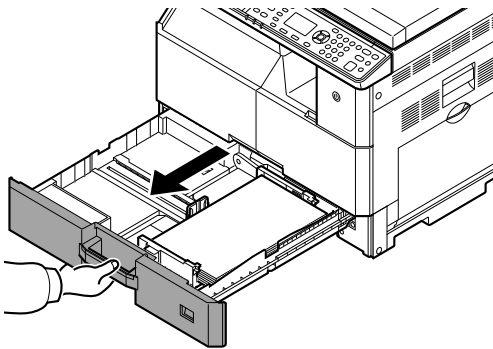

②

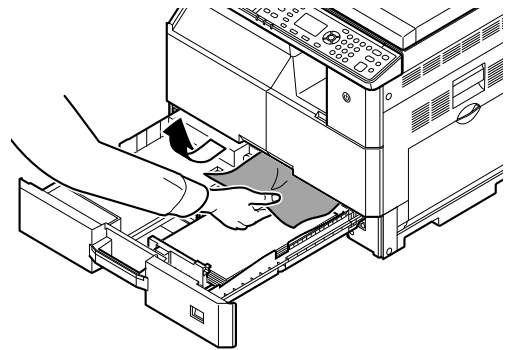

PF-480

B

①

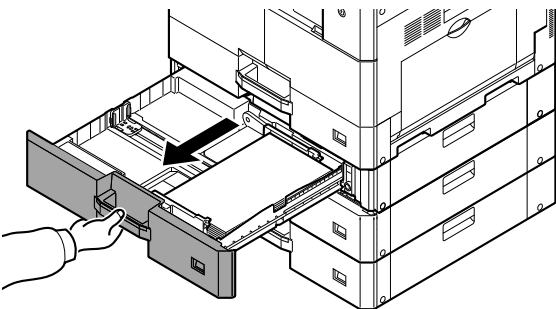
**C****D**

②

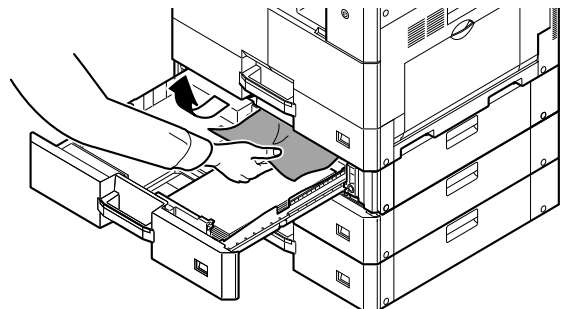

E

①

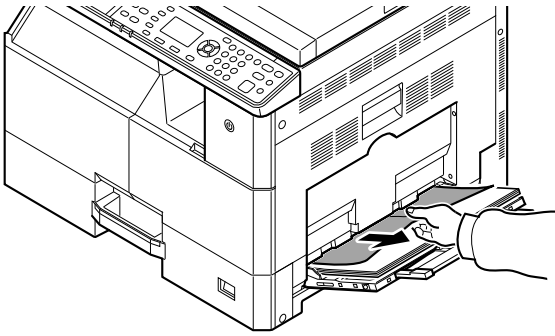

②

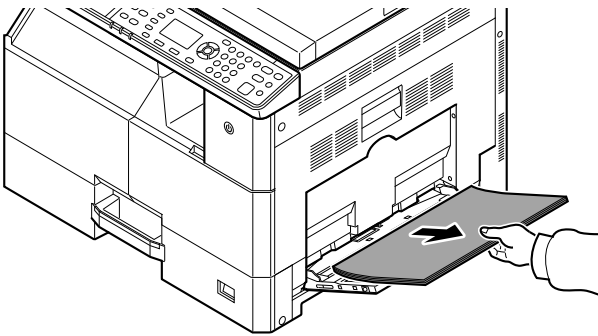

③

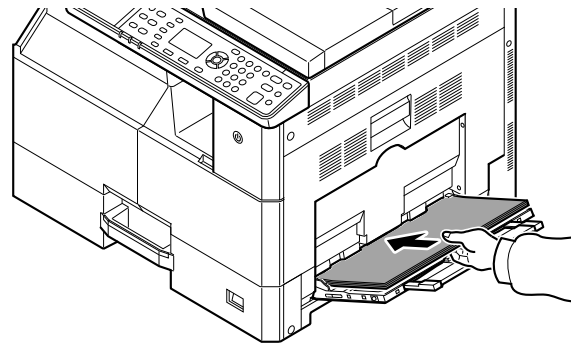
**F**

①

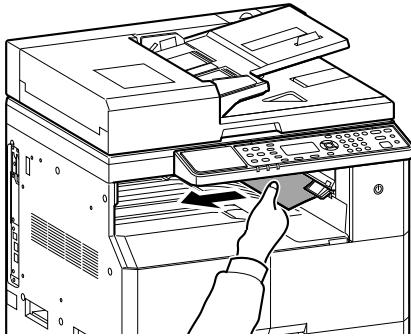

②

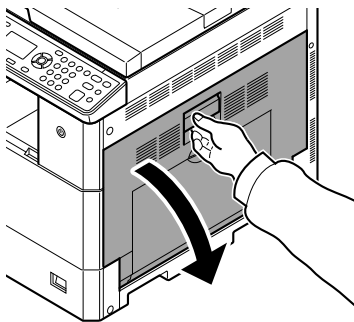

③

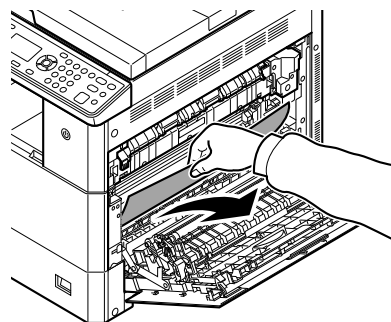

4

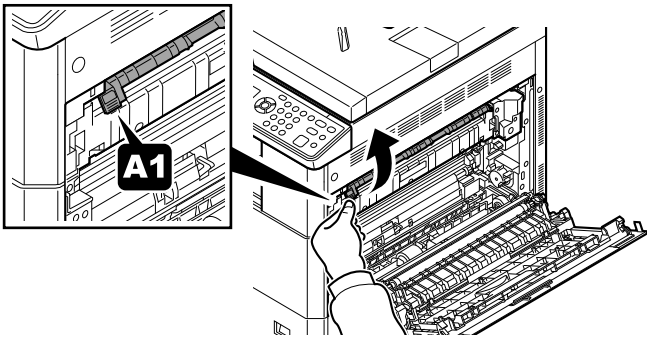

5

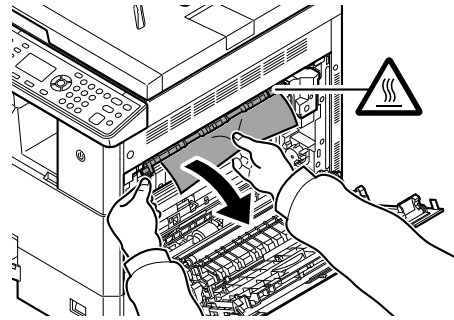

6

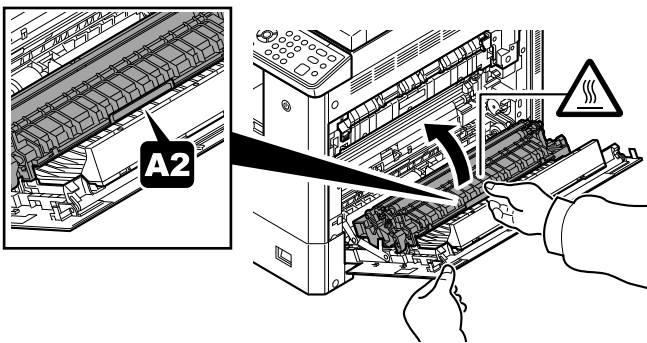

7

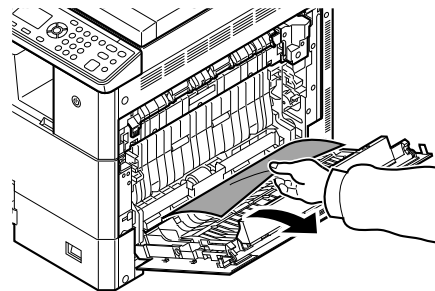

PF-480

G

1

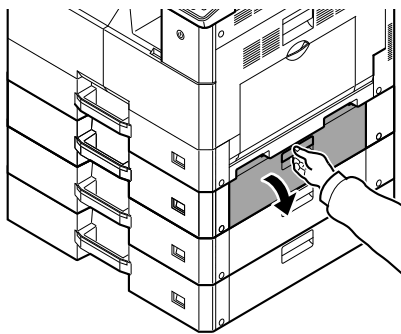

2

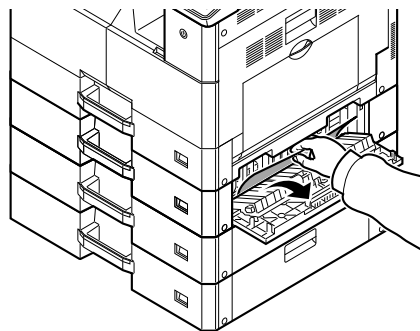

H



①

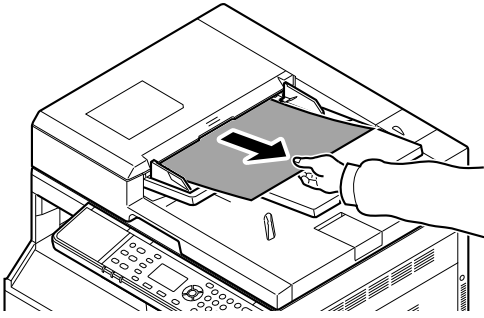

②

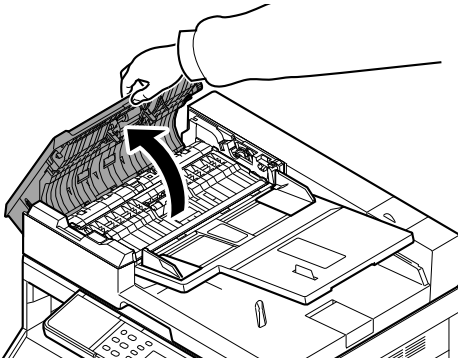

③

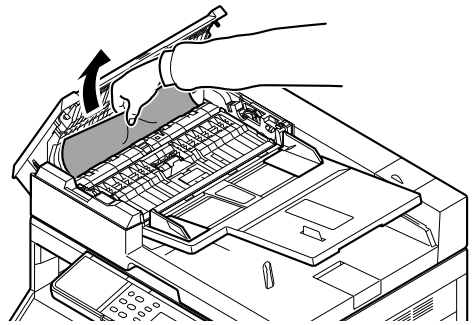

④

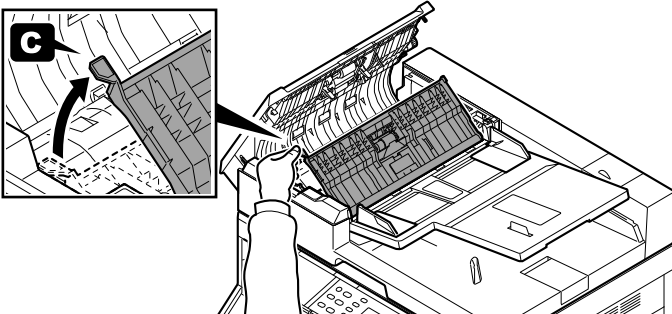

⑤

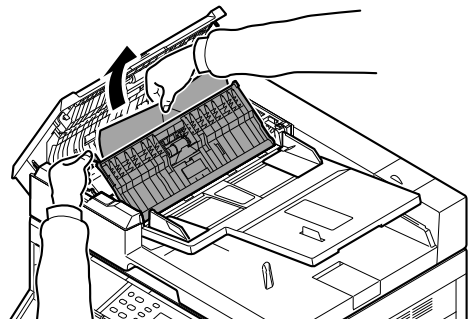

⑥

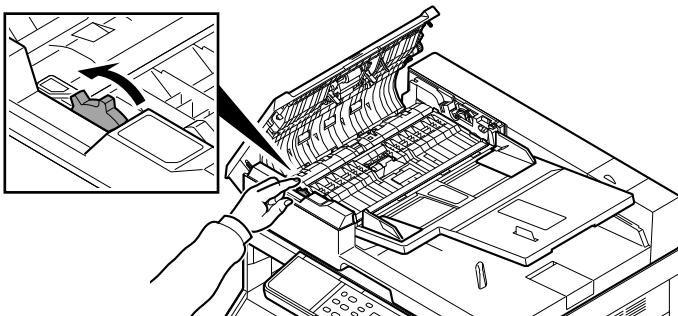

⑦

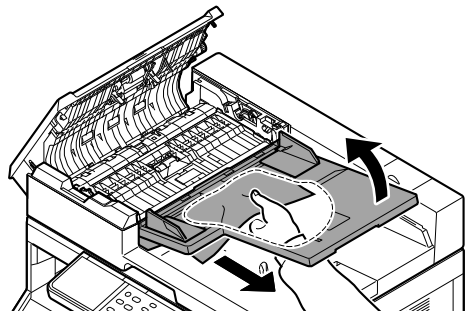



**QUALITY
CERTIFICATE**

This machine has passed
all quality controls and
final inspection.

