



Dell UltraSharp 52 Thunderbolt Hub Monitor

U5226KW/U5226KW WOST

User's Guide

Notes, cautions, and warnings

 **NOTE:** A NOTE indicates important information that helps you make better use of your product.

 **CAUTION:** A CAUTION indicates either potential damage to hardware or loss of data and tells you how to avoid the problem.

 **WARNING:** A WARNING indicates a potential for property damage, personal injury, or death.

Contents

Safety instructions	5
About your monitor	6
Package contents	6
Information available on the packaging	7
Product features	8
Operating system compatibility	11
Identifying parts and controls	11
Front view	11
Top view	12
Back view	13
Bottom view	14
Monitor specifications	15
Dell Display and Peripheral Manager (DDPM) for Windows	16
Resolution specifications	17
Supported video modes	17
Preset display modes	17
DisplayPort Video Source	18
USB-C DisplayPort-Alt. Mode Video Source	18
Thunderbolt 4 video source	18
Electrical specifications	19
Physical characteristics	20
Environmental characteristics	20
Pin assignments	21
Pin assignments - DisplayPort	21
Pin assignments - HDMI port	22
Pin assignments - Thunderbolt 4/USB-C port	23
Universal Serial Bus (USB)	24
RJ45 Port (Connector Side)	25
Plug and Play	27
LCD monitor quality and pixel policy	27
Ergonomics	28
Handling and moving your monitor	29
Maintenance guidelines	30
Cleaning your monitor	30
Setting up the monitor	31
Connecting the stand	31
Using the tilt, swivel, vertical extension, and slant adjust	33
Tilt, swivel and vertical extension	33
Slant adjust	33
Organizing your cables	34
Wall Mounting/3rd Party Arm (Optional)	35
Connecting your monitor	37
Dell Power Button Sync (DPBS)	40
Connecting the monitor for DPBS for the first time	42
Using DPBS function	43
Connect multiple Thunderbolt 4 monitors to one system	44

Securing your monitor using Kensington lock (optional)	47
Removing the monitor stand	48
VESA wall mounting (optional)	48
Operating the monitor	49
Turn on the monitor	49
Using the joystick control	49
Using the Menu Launcher	50
Using the navigation keys	52
Using the Main Menu	53
Using the OSD lock function	65
Initial Setup	68
OSD warning messages	69
Setting the maximum resolution	72
Setting the KVM USB Switch	73
Setting the Auto KVM	76
Troubleshooting	78
Self-test	78
Built-in diagnostics	79
Common problems	80
Product-specific problems	81
Universal Serial Bus (USB) specific problems	83
Regulatory information	84
TCO Certified	84
FCC notices (U.S. only) and other regulatory information	84
EU product database for energy label and product information sheet	84
Contacting Dell	85
Revision History	86

Safety instructions

Use the following safety guidelines to protect your monitor from potential damage and to ensure your personal safety. Unless otherwise noted, each procedure in this document assumes that you have read the safety information that shipped with your monitor.

NOTE: Before using the monitor, read the safety information that is shipped with your monitor and printed on the product. Keep the documentation at a secure location for future reference.

WARNING: Use of controls, adjustments, or procedures other than those specified in this documentation may result in exposure to shock, electrical hazards and/or mechanical hazards.

CAUTION: The possible long-term effect of listening to audio at high volume through the headphones (on a monitor that supports it) may cause damage to your hearing ability.

- Place the monitor on a solid surface and handle it carefully.
- The screen is fragile and can be damaged if dropped or pressed with a sharp object.
- Ensure that your monitor is electrically rated to operate with the AC power available in your location.
- Keep the monitor in room temperature. Excessive cold or hot conditions can have an adverse effect on the liquid crystal of the display.
- Connect the power cable from the monitor to a wall outlet that is near and accessible. See [Connecting your monitor](#).
- Do not place and use the monitor on a wet surface or near water.
- Do not subject the monitor to severe vibration or high impact conditions. For example, do not place the monitor inside a car trunk.
- Unplug the monitor when it is going to be left unused for an extended period.
- To avoid electric shock, do not attempt to remove any cover or touch the inside of the monitor.
- Read these instructions carefully. Keep this document for future reference. Follow all warnings and instructions that are marked on the product.
- Certain monitors can be wall mounted using the VESA mount that is sold separately. Ensure to use the correct VESA specifications as mentioned in the wall mounting section of the User's Guide.

For information about safety instructions, see the *Safety, Environmental, and Regulatory Information (SERI)* document that is shipped with your monitor.

About your monitor







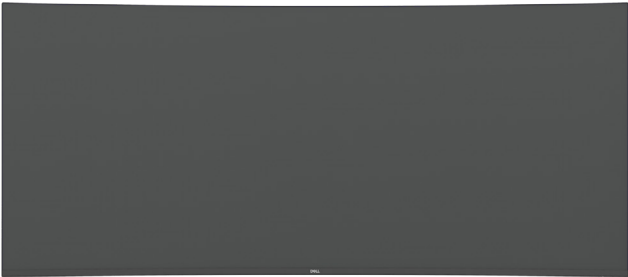

Package contents

The following table provides the list of components that are shipped with your monitor. If any component is missing, contact Dell. For more information, see [Contacting Dell](#).

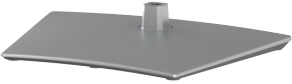
NOTE: Some components may be optional and may not ship with your monitor. Some features may not be available in certain countries.

NOTE: To set up the stand from any other source, see the documentation that comes with the stand for instructions.

Table 1. Monitor components and descriptions.

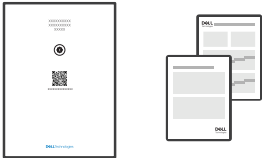
Component image	Component description
	Monitor
	Stand riser (U5226KW only)
	Stand base (U5226KW only)
	HDMI cable (1.80 m)
	DisplayPort 1.4 cable (1.80 m) (DisplayPort to DisplayPort)
	Thunderbolt 4 40Gbps cable (2.0 m)
	USB-C to USB Type-A 10Gbps cable (1.0 m)
	Power cable (varies by country or region)
	<ul style="list-style-type: none"> • QR Card • Safety, Environmental, and Regulatory Information

Information available on the packaging

Before you open the box, ensure that the box is oriented correctly:

1. Lay the packaging box on a flat surface such that the opening flap is at the top.
2. Lift the opening flap and remove the components.

The ports on the monitor are as follows:

- 2 HDMI ports (Support up to 6144 x 2560 120Hz FRL, VRR as per specified in HDMI2.1)
- 2 DisplayPort 1.4 ports (Support up to 6144 x 2560 120Hz, DSC)
- 1 Thunderbolt 4 upstream port (DP1.4 with DSC support, PD up to 140 W, USB 40 Gbps)
- 3 USB-C upstream ports (USB-C 10 Gbps, USB Gen2)
- 4 USB Type-A downstream ports (USB Type-A 10 Gbps, USB 3.2 Gen2)
- 1 RJ45 port (2.5 GbE)

Quick access port:

- 2 USB-C downstream ports (USB-C 10 Gbps, USB 3.2 Gen2) with 27W power charging
- 1 USB Type-A downstream port (USB Type-A 10 Gbps, USB 3.2 Gen2) with BC1.2 power charging

The following are the accessories that ship within the box:

- HDMI cable
- DisplayPort 1.4 cable
- Thunderbolt 4 40Gbps cable
- USB-C to USB Type-A 10Gbps cable
- Power cable

For information about recycling, see the [Dell recycling](#) website.

Product features

The **Dell UltraSharp U5226KW** monitor has an active matrix, Thin-Film Transistor (TFT), Liquid Crystal Display (LCD), anti-static, and LED backlight. The monitor has the following features:

- **U5226KW:** 1307.5 mm (51.5 in.) active area display (measured diagonally).
- **U5226KW:** 6144 x 2560 (21:9) resolution, plus full-screen support for lower resolutions.
- Wide viewing angles with 100% sRGB, 100% BT.709, 99% Display P3 and 99% DCI-P3 color with an average Delta E < 1.5.
- Tilt, swivel, and height adjustment capabilities.
- Integrated speakers (2 x 9 W).
- Removable pedestal stand and Video Electronics Standards Association (VESA) mounting holes for flexible mounting solutions.
- Auto Brightness function automatically adjusts monitor brightness and color temperature based on the detected ambient light, and multiple Dell monitors with the Auto Brightness function could synchronize their brightness and color temperature level.
- Ultra-thin bezel minimizes the bezel gap during multi-monitor usage, enabling easier set up with an elegant viewing experience.
- Extensive digital connectivity with DP helps future-proof your monitor.
- Thunderbolt 4 to supply power to compatible notebook while receiving video signal.
- Thunderbolt 4 and RJ45 ports enable a single-cable, network-connected experience.
- Plug and play capability if supported by your computer.
- On-Screen Display (OSD) adjustments for ease of set-up and screen optimization.
- Power and OSD buttons lock.
- Security lock slot.
- ≤ 0.3 W in Off Mode.
- The monitor supports VRR (Variable refresh rate) function, which helps achieve higher frame rates and reduce screen tearing in games.
- The monitor supports DRR (Dynamic refresh rate) function, DRR works with all Windows 11 tasks, allowing you to automatically increase the refresh rate (for a smoother experience) while using the PC or NB for writing or scrolling, and lower the refresh rate when you don't need it, which saves more power.
- Supports Picture by Picture (PBP) and Picture in Picture (PIP) Select mode.
- Supports Wake On Lan S3, S4/S5* and MAPT (MAC Address Pass Through).
- Allow user to switch USB KVM function in PBP mode.
- The monitor is designed with Dell Power Button Sync (DPBS) feature to control PC system power state from monitor power button.*
- Supports internal MST (Multi-Stream Transport) function (Screen Partition item in OSD) for DP port & Thunderbolt 4 (Video + Data).
- Supports internal MST and PBP function (PBP with Screen Partition item in OSD) for DP port & Thunderbolt 4 (Video + Data).
- Premium Panel Exchange for peace of mind.
- Optimize eye comfort with a flicker-free screen and low blue light feature to minimize hazardous blue light emission.
- Dell ComfortView Plus is an integrated low blue light screen feature that improves eye comfort by reducing potentially harmful blue light emissions without compromising color. Through ComfortView Plus technology, Dell has reduced harmful blue light exposure to ≤20%. This monitor is certified with TÜV Rheinland Eye Comfort 3.0 with a 5-star rating. It incorporates key technologies that also deliver a flicker-free screen, up to 120 Hz refresh rate, a color gamut of minimum 96% DCI-P3, color accuracy, and ambient light sensor performance. Dell ComfortView Plus feature is enabled by default on your monitor.

Blue light ratio:

The ratio of light in the range from 415nm-455nm compared to 400nm-500nm is less than or equal to 20%.

Table 2. Blue light ratio.

Category	Blue light ratio
1	≤20%
2	20% < R ≤ 35%
3	35% < R ≤ 50%

- Decreases the level of hazardous blue light that is emitted from the screen to make viewing more comfortable for your eyes without distorting color accuracy.
- The monitor adopts Flicker-Free technology, which eliminates visible flicker, providing a comfortable viewing experience and preventing eye strain and fatigue.

* For Dell systems that support this feature.

About TÜV Rheinland Eye Comfort 3.0

TÜV Rheinland Eye Comfort 3.0 certification program presents a consumer-friendly star rating scheme to the display industry promoting eye wellness from safety to eye care. Compared to existing certifications, the 5-star-rating program adds rigorous testing requirements on overall eye care attributes such as low blue-light, flicker-free, refresh rate, color gamut, color accuracy and ambient light sensor performance. It lays out requirement metrics and rates the product performance on five levels, and the sophisticated technical assessment process provides consumers and buyers with indicators that are easier to judge.

The eye wellness factors being considered remain constant, however, the standards for the various star ratings are different. The higher the star rating, the more stringent the standards. The table below lists the major eye comfort requirements which apply in addition to the basic eye comfort requirements (such as pixel density, uniformity of luminance and color, and freedom of movement).

For more information around **TÜV Eye Comfort certification** please refer to:

[Eye Comfort Certification](#)



Table 3. Eye Comfort 3.0 Requirements and Star Rating Scheme for Monitors.

Category	Test item	Star Rating Scheme		
		3-star	4-star	5-star
Eye Care	Low Blue Light	TÜV Hardware LBL Category III ($\leq 50\%$) or Software LBL solution ¹	TÜV Hardware LBL Category II ($\leq 35\%$) or Category I ($\leq 20\%$)	TÜV Hardware LBL Category II ($\leq 35\%$) or Category I ($\leq 20\%$)
	Flicker Free	TÜV Flicker Reduced or TÜV Flicker Free	TÜV Flicker Reduced or TÜV Flicker Free	Flicker Free
Ambient Light Management	Ambient Light Sensor performance	No sensor	No sensor	Ambient light sensor
	Intelligent CCT control	No	No	Yes
	Intelligent Luminance control	No	No	Yes
Image quality	Refresh Rate	$\geq 60\text{Hz}$	$\geq 75\text{Hz}$	$\geq 120\text{Hz}$
	Luminance uniformity	Luminance uniformity $\geq 75\%$		
	Color Uniformity	Color uniformity $\Delta u'v' \leq 0.02$		
	Freedom of movement	Luminance changes shall decrease less than 50%; The colour shift shall be less than 0.01		
	Gamma difference	Gamma difference $\leq \pm 0.2$	Gamma difference $\leq \pm 0.2$	Gamma difference $\leq \pm 0.2$
	Wide color gamut ²	NTSC ³ Min.72% (CIE 1931) or sRGB ⁴ Min 95% (CIE 1931)	sRGB ⁴ Min.95% (CIE 1931)	DCI-P3 ⁵ Min. 95% (CIE 1976) & sRGB ⁴ Min.95% (CIE 1931) or Adobe RGB ⁶ Min.95% (CIE 1931) & sRGB ⁴ Min.95% (CIE 1931)
Eye Comfort User Guide	User guide	Yes	Yes	Yes
Remark	¹ Software controls the blue light emission by reducing excessive blue light, resulting in a more yellow tone. ² Color gamut describes the availability of colors in the display. Various standards were developed for specific purposes. 100% corresponds to the full color space as defined in the standard. ³ NTSC stands for National Television Standards Committee, which developed a color space for the television system that is used in the United States. ⁴ sRGB is a standard red, green, and blue color space that is in use on monitors, printers, and the World Wide Web. ⁵ DCI-P3, short for Digital Cinema Initiatives - Protocol 3, is a color space used in digital cinema that encompasses a wider range of colors than the standard RGB color space. ⁶ Adobe RGB is a color space created by Adobe Systems that encompasses a broader range of colors than the standard RGB color model, particularly in the cyans and greens.			

Operating system compatibility

- Windows 10 and later*
- macOS 12 and later*

*The operating system compatibility on Dell and Alienware branded monitors may vary based on factors such as:

1. Specific release date(s) when operating system versions, patches, or updates are available.
2. Specific release date(s) when Dell and Alienware branded monitor firmware, software application, or driver updates are available on the Dell support website.

Identifying parts and controls

Front view

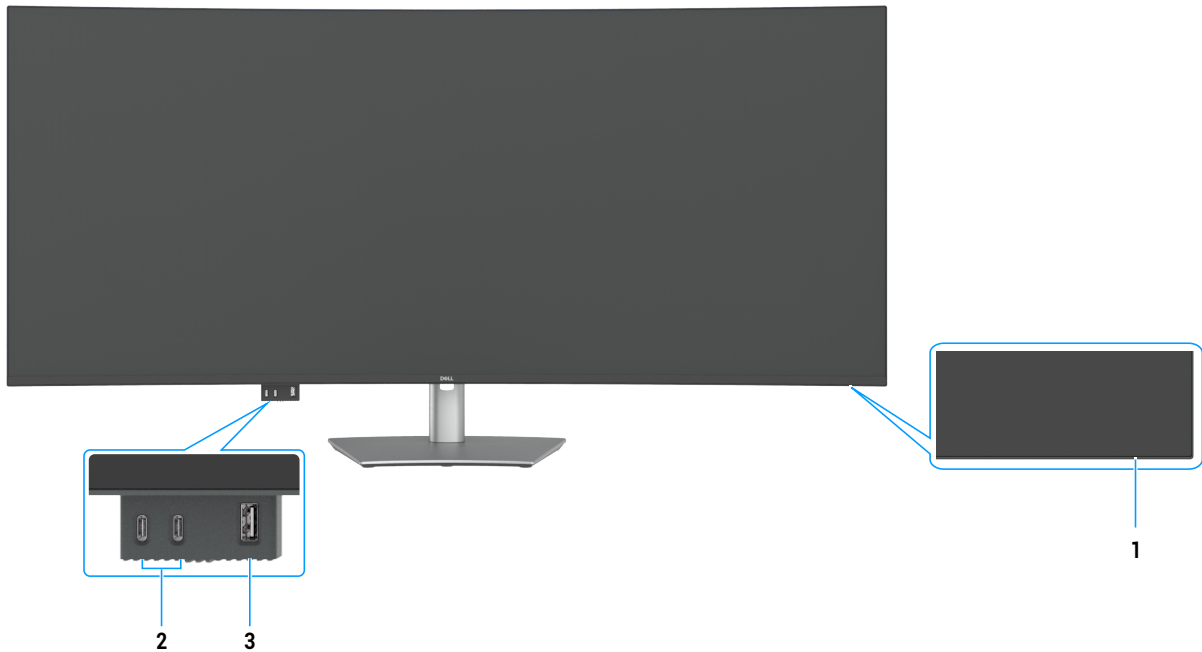

Figure 1. Front view

Table 4. Components and descriptions.

Label	Description	Function
1	Power indicator LED	Solid white light indicates that the monitor is turned on and is functioning. Blinking white light indicates that the monitor is in Standby Mode.
2	2 x USB-C 10Gbps downstream port with power charging (27W)	Connect your USB device. The USB-C port supports 5 V/3 A, 9 V/3 A.
3	USB Type-A 10Gbps downstream port with BC1.2 5 V/1.5 A typical (2 A max) power charging (10W)	Connect your USB device. The USB port supports Battery Charging Rev. 1.2.

NOTE: You can use this port only after you have connected the USB cable (A to C or C to C) to the USB-C or Thunderbolt 4 upstream port at the rear of the monitor to the PC.

Top view

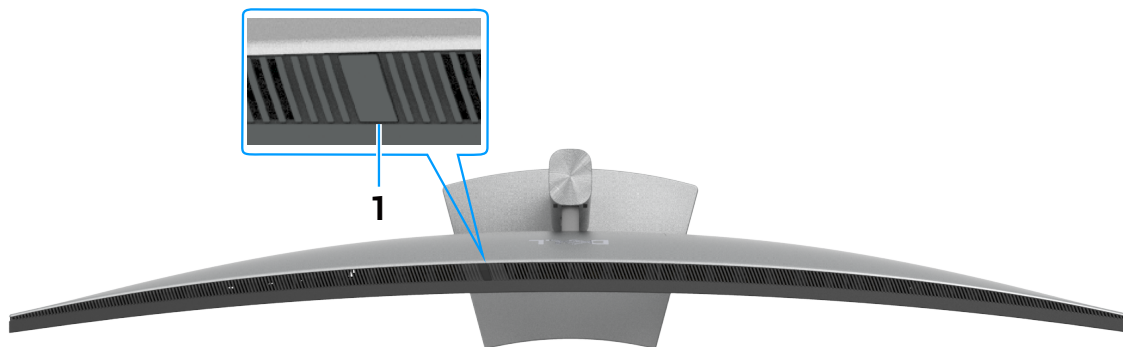

Figure 2. Top view

Table 5. Components and descriptions.

Label	Description	Function
1	Ambient light sensor	Detects ambient light and adjusts the brightness of the display accordingly. For more information, see Auto Brightness and Auto Color Temp. i NOTE: If the Ambient light sensor detects abnormal change in the light level, see Ambient light detection anomaly .

Back view



Figure 3. Back view

Table 6. Components and descriptions.

Label	Description	Function
1	VESA mounting holes (200 mm x 200 mm / 200 mm x 100 mm / 100 mm x 100 mm) - behind attached VESA cover	<ul style="list-style-type: none"> Wall-mount the monitor using VESA-compatible Wall-mount kit/3rd Party Arm. Also to specify the screw dept for these mounting holes.
2	Regulatory information label	Lists the regulatory approvals.
3	Stand release button	Releases the stand from the monitor.
4	Power button	To turn the monitor on or off.
5	Joystick	Use it to control the OSD menu. For more information, see Operating the monitor .
6	Regulatory label (including MAC address, barcode, serial number, and Service Tag label)	See this label if you need to contact Dell for technical support. The Service Tag is a unique alphanumeric identifier that allows Dell service technicians to identify your monitor's specifications and access warranty information.
7	Cable management slot	Use to organize cables by inserting them through the slot.

Bottom view

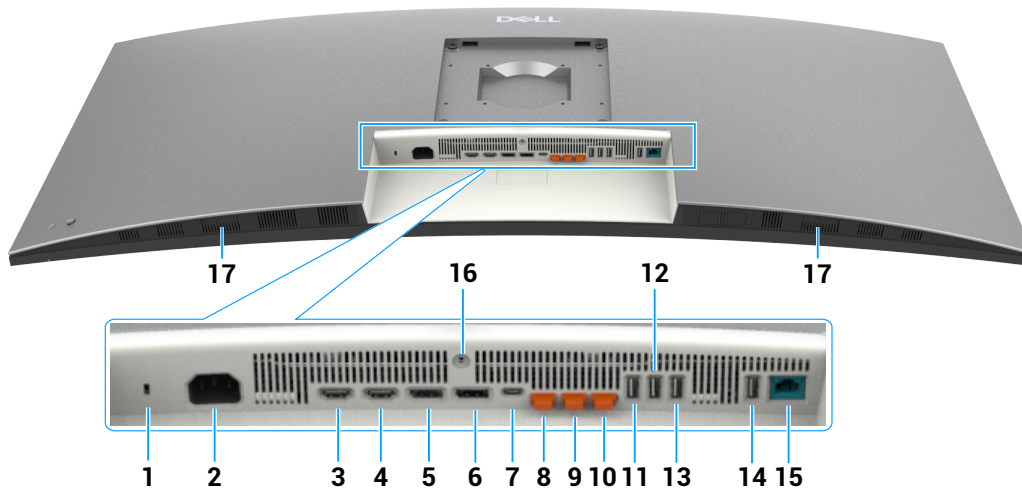









Figure 4. Bottom view

Table 7. Components and descriptions.

Label	Description	Function
1	Security lock slot	Secures monitor with security cable lock (sold separately).
2	 Power connector	Connect the power cable.
3, 4	 HDMI 2.1 port (2)	Connect your computer with the HDMI cable.
5, 6	 DisplayPort 1.4 port (in) (2)	Connect your computer with the DisplayPort cable.
7	 Thunderbolt 4 upstream (Video + Data). Alternate mode with DisplayPort 1.4, Power Delivery up to 140 W	Connect to your computer using the Thunderbolt cable. The Thunderbolt 4 upstream offer the fastest transfer rate (USB 3.2 Gen 2), TBT mode and the alternate mode with DP 1.4 support the following, and 28 V/5 A, 20 V/4.5 A, 15 V/3 A, 9 V/3 A, 5 V/3 A. Maximum resolution of 6144 x 2560 at 120 Hz.* This model will feature Thunderbolt 4 technology and will have a 140 W power delivery, it is recommended for use the following Dell's products that meet the fire enclosures. *6144 x 2560@120 Hz timing resolution support depends on GfX capability.
8, 9, 10	 USB-C upstream port (data only) (3) 	Connect to your computer using the USB cable (Thunderbolt 4 cable, A to C or C to C). Once the USB cable is connected, you can use the USB downstream connectors on the monitor.
11, 12, 13, 14	 Super speed USB 10 Gbps ports (4)	Connect your USB device. You can use these ports only after you have connected the USB cable (Thunderbolt 4 cable, A to C or C to C) from the computer to the monitor. The USB port supports 5 V/0.9 A.
15	 RJ45 connector (2.5G)	Connect Internet. You can surf Internet via RJ45 only after you have connected the USB cable (Thunderbolt 4 cable, A to C or C to C) from the computer to the monitor.
16	Stand lock	Lock the stand to the monitor using a M3 x 8 mm screw (screw not included).
17	Built-in speakers	To output the sound from an audio input.

Monitor specifications

Table 8. Monitor specifications.

Specification	
Screen type	Active matrix-TFT LCD
Panel technology	In-Plane Switching (IPS) Black Technology
Aspect ratio	21:9
Viewable image dimensions	
Diagonal	1307.5 mm (51.5 in.)
Active Area	
Horizontal	1206.93 mm (47.52 in.)
Vertical	502.89 mm (19.80 in.)
Area	606947.36 mm ² (940.77 in. ²)
Pixel pitch	
Horizontal	0.19644 mm
Vertical	0.19644 mm
Pixel per inch (PPI)	129
Viewing angle	
Horizontal	178° (typical)
Vertical	178° (typical)
Brightness	400 cd/m ² (typical)
Contrast ratio	2000:1 (typical)
Display screen coating	Anti-Glare Low Reflectance (AGLR) with hard-coating 3H
Backlight	LED Edgelight System
Response Time (Gray to Gray)	Fast mode: 5 ms GTG Normal mode: 8 ms GTG
Color depth	1.07 billion colors
Color gamut	sRGB 100% (CIE 1931) (typical) BT.709 100% (CIE 1931) (typical) DCI-P3 99% (CIE 1976) (typical) Display P3 99% (CIE 1976) (typical)
Calibration accuracy	Delta E <1.5 (average) (sRGB, BT.709, DCI-P3, Display P3)
Connectivity	<ul style="list-style-type: none"> • 2 x HDMI port (Supports up to 6144 x 2560 120Hz FRL, VRR as per specified in HDMI2.1)* • 2 x DisplayPort 1.4 port (Support up to 6144 x 2560 120Hz, DSC) • 1 x Thunderbolt 4 upstream port (DP1.4 with DSC support, PD up to 140 W, USB 40 Gbps) • 3 x USB-C upstream port (USB-C 10 Gbps, USB Gen2) • 4 x USB Type-A downstream port (USB Type-A 10 Gbps, USB 3.2 Gen2) • 1 x RJ45 port (2.5 GbE) Quick Access port: <ul style="list-style-type: none"> • 2 x USB-C downstream port (USB-C 10 Gbps, USB 3.2 Gen2) with 27W power charging • 1 x USB Type-A downstream port (USB Type-A 10 Gbps, USB 3.2 Gen2) with BC1.2 power charging
Border width (edge of monitor to active area)	
Top	10.34 mm (0.41 in.)
Left/Right	10.34 mm (0.41 in.)
Bottom	15.80 mm (0.62 in.)
Adjustability	
Height adjustable stand	90.00 mm (3.54 in.)
Tilt	-5° to 10°
Swivel	-20° to 20°
Cable management	Yes
Dell Display and Peripheral Manager (DDPM) Compatibility	Easy Arrange and other key features
Security	Security lock slot (cable lock sold separately)

Specification	
Built-in speakers	2 x 9W

* Not supporting the HDMI 2.1 optional specification, including HDMI Ethernet Channel (HEC), Audio Return Channel (ARC), standard for 3D format and resolutions, standard for 4K digital cinema resolution, Enhanced Audio Return Channel (eARC), Quick Media Switching (QMS), Quick Frame Transport (QFT), Auto Low Latency Mode (ALLM), Display Stream Compression (DSC), and Source-Based Tone Mapping (SBTM).

Dell Display and Peripheral Manager (DDPM) for Windows

DDPM is a software application that helps you set up and configure the Dell monitors and peripherals. Some of its features include:

1. Adjusting the monitor On-Screen Display (OSD) settings such as brightness, contrast, and resolution without needing to use the joystick on the monitor.
 2. Arrange multiple applications on your screen by placing them into a template of your choice using **Easy Arrange**.
 3. Assign applications or files to the partitions of **Easy Arrange**, save the layout as a profile, and restore the profile automatically with **Easy Arrange Memory** when needed.
 4. Connect the Dell Monitor to multiple input sources and manage these video inputs using the **Input Source** feature.
 5. Customize each application with its own distinct color mode using the **Color Preset** feature.
 6. Replicate software application settings from one monitor to another identical monitor using the **Import/Export** application settings feature.
 7. Receive notifications and update the firmware and software.
 8. If the display supports the Keyboard Video Mouse (KVM) feature, you can set up and share the keyboard and mouse across connected computers using the **USB KVM** option.
 9. Also, if the display supports the **Network KVM** feature, then you can share the keyboard and mouse across computers on the same network and transfer files between them.
 10. A macOS version of DDPM software is also available for your monitor. For the list of displays that support DDPM macOS version, see the knowledge base article 000201067 at [Dell Support Site](#).
- ① **NOTE:** Some features of the DDPM mentioned above are available only on select monitor models. For more information about DDPM, and the recommended computer configuration to install it, go to [Dell Display and Peripheral Manager](#).

Resolution specifications

Table 9. Resolution specifications.

Specification	
Horizontal frequency	30 kHz to 326 kHz
Vertical refresh rate	48 Hz to 120 Hz
Default preset resolution	6144 x 2560 at 60 Hz
Maximum preset resolution	6144 x 2560 at 120 Hz

Supported video modes

Table 10. Supported video modes.

Specification	
Video display capabilities (HDMI & DisplayPort & Thunderbolt mode and alternate mode)	480p at 60 Hz 576p at 50 Hz 720p at 60 Hz 1080p at 30/50/60 Hz 2160p at 24/25/30/50/60/120 Hz

Preset display modes

Table 11. Preset display modes.

Display mode	Horizontal frequency (kHz)	Vertical frequency (Hz)	Pixel clock (MHz)	Sync polarity (Horizontal/Vertical)
VGA, 720 x 400	31.47	70.08	28.32	-/+
VGA, 640 x 480	31.47	59.94	25.18	-/-
VGA, 640 x 480	37.50	75.00	31.50	-/-
SVGA, 800 x 600	37.88	60.32	40.00	+/+
SVGA, 800 x 600	46.88	75.00	49.50	+/+
XGA, 1024 x 768	48.36	60.00	65.00	-/-
XGA, 1024 x 768	60.02	75.03	78.75	+/+
SXGA, 1152 x 864	67.50	75.00	108.00	+/+
SXGA, 1280 x 800	49.31	59.91	71.00	+/+
SXGA, 1280 x 1024	64.00	60.02	108.00	+/+
SXGA, 1280 x 1024	79.98	75.03	135.00	+/+
SXGA, 1600 x 900	60.00	60.00	108.00	+/+
WUXGA, 1600 x 1200	75.00	60.00	162.00	+/+
WSXGA+, 1680 x 1050	65.29	59.95	146.25	-/+
FHD, 1920 x 1080	67.50	60.00	148.50	+/+
WUXGA, 1920 x 1200	74.56	59.89	193.25	-/+
QHD, 2560 x 1440	88.79	59.95	241.50	+/-
UHD 3840 x 2160 (DP)	133.31	60.00	533.25	+/-
UHD 3840 x 2160 (HDMI)	135.00	60.00	594.00	+/+
UHD 3840 x 2160	274.44	120.00	1097.75	+/-
CVT 6144x2560	77.84	30	490.75	+/-
CVT 6144x2560	157.95	60	995.75	+/-
CVT 6144x2560(DP)	325.19	120	2050.00	+/-
CVT 6144x2560(HDMI)	325.176	120	2122.75	+/-

DisplayPort Video Source

Table 12. DisplayPort Single.

Host	Upstream cable	Platform DSC	Monitor Max Resolution
DisplayPort (HBR3 DSC)	DisplayPort cable (USB data need connect upstream cable)	DSC1/2.4	6K 120 Hz 24 bit
DisplayPort (HBR2 no DSC)		DSC1/3	6K 120 Hz 30 bit
		NA	4K 60 Hz 30 bit
DisplayPort (HBR2 DSC)		DSC1/2.4	4K 120 Hz 30 bit
		DSC1/3	4K 120 Hz 30 bit

USB-C DisplayPort-Alt. Mode Video Source

Table 13. High resolution(4Lane).

Host	Upstream cable	Platform DSC	Monitor Max Resolution
USB-C (Alt Mode HBR3 8.1G) (4Lane DSC)	USB-C 10Gbps cable or TBT cable	DSC1/2.4	6K 120 Hz 24 bit
		DSC1/3	6K 120 Hz 30 bit
USB-C (Alt Mode HBR2 5.4) (4Lane DSC)		DSC1/2.4	4K 120 Hz 30 bit
		DSC1/3	4K 120 Hz 30 bit
USB-C (Alt Mode HBR2 5.4) (4Lane no DSC)		NA	4K 60 Hz 30 bit

NOTE: Under High Resolution, USB data available is USB 2.0.

Table 14. High Data Speed(2lane).

Host	Upstream cable	Platform DSC	Monitor Max Resolution
USB-C(Alt Mode HBR3 8.1G) (2Lane DSC)	USB Type-C 10Gbps cable or TBT cable	DSC1/2.4	6K 60 Hz 24 Bit
		DSC1/3	6K 60 Hz 30 Bit
USB-C(Alt Mode HBR2 5.4 G) (2Lane no DSC)		NA	4K 30 Hz 24 Bit
		DSC1/2.4	4K 60 Hz 30 Bit
USB-C(Alt Mode HBR2 5.4 G) (2Lane DSC)		DSC1/3	

NOTE: Under High Data Speed, USB data available is USB3.0.

Thunderbolt 4 video source

Table 15. Thunderbolt 4.

Host	Upstream cable	Platform DSC	Monitor Max Resolution
TBT4	Thunderbolt 4 Active/passive cable (40G) or USB-C 10Gbps cable	DSC1/2.4	6K 120 Hz 24 bit (USB 3.0)
		DSC1/3	6K 120 Hz 30 bit (USB 3.0)

Electrical specifications

Table 16. Electrical specifications.

Specification	
Video input signals	<ul style="list-style-type: none"> Digital video signal for each differential line per differential line at 100 Ω impedance DisplayPort/HDMI/Thunderbolt 4 signal input support
Input voltage/frequency/current	100 VAC to 240 VAC / 50 Hz or 60 Hz \pm 3 Hz / 5.5 A (maximum)
Inrush current	<ul style="list-style-type: none"> 120 V: 42 A (maximum) 240 V: 80 A (maximum) Inrush current is measured at an ambient temperature of 0°C (cold start).
Power Consumption	0.3 W (Off Mode) ¹ 0.5 W (Standby Mode) ¹ 2.0 W (Networked standby Mode) ¹ 63.6 W (On Mode) ¹ 430 W (maximum) ² 51.4 W (P_{on}) ³ 166.4 kWh (TEC) ³

¹ As defined in EU 2019/2021 and EU 2019/2013.

² Maximum brightness and contrast setting with maximum power loading on all USB ports.

³ P_{on} : Power consumption of On Mode as defined in Energy Star 8.0 version.

TEC: Total energy consumption in kWh as defined in Energy Star 8.0 version.

This document is informational only and reflects laboratory performance. Your product may perform differently, depending on the software, components and peripherals you ordered and shall have no obligation to update such information. Accordingly, the customer should not rely upon this information in making decisions about electrical tolerances or otherwise. No warranty as to accuracy or completeness is expressed or implied.

 **NOTE:** This monitor is ENERGY STAR certified.



This product qualifies for ENERGY STAR in the factory default settings which can be restored by "Factory Reset" function in the OSD menu. Changing the factory default settings or enabling other features may increase power consumption that could exceed the ENERGY STAR specified limit.

Physical characteristics

Table 17. Physical characteristics.

Model	U5226KW	U5226KW WOST*
Dimensions (with stand)		
Height (extended)	666.79 mm (26.25 in.)	NA
Height (compressed)	576.79 mm (22.70 in.)	NA
Width	1223.32 mm (48.16 in.)	NA
Depth	255.00 mm (10.04 in.)	NA
Dimensions (without stand)		
Height	529.05 mm (20.83 in.)	
Width	1223.32 mm (48.16 in.)	
Depth	111.94 mm (4.41 in.)	
Stand dimensions		
Height (extended)	526.90 mm (20.74 in.)	NA
Height (compressed)	426.50 mm (16.79 in.)	NA
Width	363.00 mm (14.29 in.)	NA
Depth	255.00 mm (10.04 in.)	NA
Base	363.00 mm x 255.00 mm (14.29 in. x 10.04 in.)	NA
Weight		
Weight with packaging	34.85 kg (76.83 lb)	30.04 kg (66.23 lb)
Weight with stand assembly and cables	18.23 kg (40.19 lb)	NA
Weight without stand assembly and with cables	NA	13.42 kg (29.59 lb)
Weight without stand assembly (For wall mount or VESA mount considerations - no cables)	12.95 kg (28.57 lb)	12.95 kg (28.57 lb)
Weight of stand assembly	4.81 kg (10.60 lb)	NA

* U5226KW WOST: U5226KW without stand assembly.

Environmental characteristics

Table 18. Environmental characteristics.

Specification	
Temperature	
Operating	0°C to 40°C (32°F to 104°F)
Non-operating	-20°C to 60°C (-4°F to 140°F)
Humidity	
Operating	10% to 80% (non-condensing)
Non-operating	5% to 90% (non-condensing)
Altitude	
Operating (maximum)	5,000 m (16,404 ft)
Non-operating (maximum)	12,192 m (40,000 ft)
Thermal dissipation	1467.22 BTU/hour (maximum) 217.01 BTU/hour (on mode)
Compliant Standards	<ul style="list-style-type: none"> ENERGY STAR certified monitor EPEAT registered where applicable. EPEAT registration varies by country. See EPEAT for registration status by country. TCO Certified & TCO Certified Edge. RoHS Compliant. BFR/PVC free monitor (excluding external cables). Arsenic-free glass and Mercury-free for the panel only.

Pin assignments

Pin assignments - DisplayPort

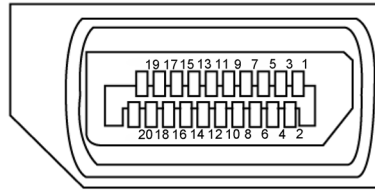

Figure 5. DisplayPort

Table 19. DisplayPort.

Pin number	Signal assignment
1	ML3(n)
2	GND
3	ML3(p)
4	ML2(n)
5	GND
6	ML2(p)
7	ML1(n)
8	GND
9	ML1(p)
10	ML0(n)
11	GND
12	ML0(p)
13	CONFIG1
14	CONFIG2
15	AUX CH (p)
16	GND
17	AUX CH (n)
18	Hot Plug Detect
19	Return
20	DP_PWR

Pin assignments - HDMI port

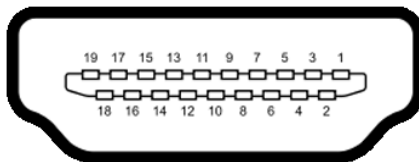

Figure 6. HDMI port

Table 20. HDMI port

Pin number	Signal assignment
1	TMDS DATA 2+
2	TMDS DATA 2 SHIELD
3	TMDS DATA 2-
4	TMDS DATA 1+
5	TMDS DATA 1 SHIELD
6	TMDS DATA 1-
7	TMDS DATA 0+
8	TMDS DATA 0 SHIELD
9	TMDS DATA 0-
10	TMDS CLOCK+
11	TMDS CLOCK SHIELD
12	TMDS CLOCK-
13	CEC
14	Reserved (N.C. on device)
15	DDC CLOCK (SCL)
16	DDC DATA (SDA)
17	DDC/CEC Ground
18	+5 V POWER
19	HOT PLUG DETECT

Pin assignments - Thunderbolt 4/USB-C port

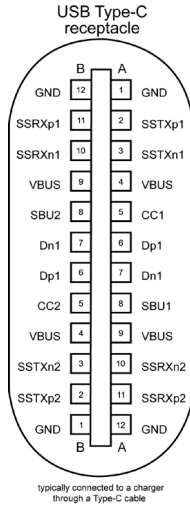

Figure 7. Thunderbolt 4/USB-C port

Table 21. Thunderbolt 4/USB-C port.



Pin	Signal	Pin	Signal
A1	GND	B12	GND
A2	SSTXp1	B11	SSRXp1
A3	SSTXn1	B10	SSRXn1
A4	VBUS	B9	VBUS
A5	CC1	B8	SBU2
A6	Dp1	B7	Dn1
A7	Dn1	B6	Dp1
A8	SBU1	B5	CC2
A9	VBUS	B4	VBUS
A10	SSRXn2	B3	SSTXn2
A11	SSRXp2	B2	SSTXp2
A12	GND	B1	GND

Universal Serial Bus (USB)

This section gives you information about the USB ports available on your display.

Your monitor has the following USB ports:

- 1 Thunderbolt 4 upstream port - at rear
- 3 USB-C upstream port (data only) - at rear
- 2 USB-C downstream port - at Quick Access
- 5 USB Type-A 10Gbps downstream ports- 4 at rear, 1 at Quick Access

i NOTE: Up to 2 A on USB downstream port (port with  icon) with BC 1.2 compliance devices at quick access; up to 3 A on USB-C downstream port (port with  icon) with 9 V/3 A compliance devices.

i NOTE: The monitor's USB ports work only when the monitor is on or in Standby Mode. On in Standby Mode, if the USB cable (A to C or C to C) is plugged in, the USB ports can work normally. Otherwise, follow the OSD setting of Other USB Charging, if the setting is "On in Standby Mode" then USB work normally, otherwise USB is disabled. If you turn off the monitor and then turn it on, the attached peripherals may take a few seconds to resume normal functionality.

Table 22. Transfer speed, data rate and common power consumption of USB ports.

Transfer speed	Data rate	Common power consumption (each port)
USB 5 Gbps/USB 10 Gbps	5 Gbps/10 Gbps	4.5 W
USB 2.0*	480 Mbps	4.5 W
USB 1.0*	12 Mbps	4.5 W

* Device speed when High Resolution is selected.

Table 23. Universal Serial Bus (USB).

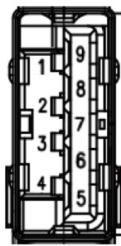

Figure 8. USB Type-A 10Gbps downstream port (bottom)

Pin number	Signal name
1	VBUS
2	D-
3	D+
4	GND
5	StdA_SSRX-
6	StdA_SSRX+
7	GND_DRAIN
8	StdA_SSTX-
9	StdA_SSTX+
Shell	Shield

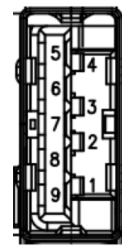

Figure 9. USB Type-A 10Gbps downstream port (rear)

Pin number	Signal name
1	VBUS
2	D-
3	D+
4	GND
5	StdA_SSRX-
6	StdA_SSRX+
7	GND_DRAIN
8	StdA_SSTX-
9	StdA_SSTX+
Shell	Shield

Thunderbolt 4 upstream

- Video DisplayPort 1.4
- Video Thunderbolt 4
- Data USB 10Gbps
- Power Delivery (PD) Up to 140 W

RJ45 Port (Connector Side)

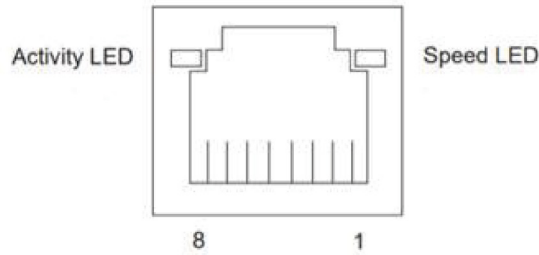

Figure 10. RJ45 Port (Connector Side)

Table 24. Port (Connector Side).

Pin No.	10BASE-T 100BASE-T	1000BASE-T 2500BASE-T
1	Transmit+	BI_DA+
2	Transmit-	BI_DA-
3	Receive+	BI_DB+
4	Unused	BI_DC+
5	Unused	BI_DC-
6	Receive-	BI_DB-
7	Unused	BI_DD+
8	Unused	BI_DD-

Driver installation

Install the Realtek USB GBE Ethernet Controller Driver available for your system. This is available for download at [Dell Support Site](#) under the “Driver and download” section.

Network (RJ45) data rate via USB-C max speed is 2.5 Gbps.

Table 25. Wake-on-LAN behavior.

Computer power save state	System behavior after receiving Wake-on-LAN (WOL) command
Modern Standby (S0ix)	The computer and Monitor remain in Standby mode but the network communication is enabled.
Standby/Sleep (S3)	Both computer and monitor are turned on.
Hibernate (S4)	Both computer and monitor are turned on.
OFF/Shutdown (S5)	Both computer and monitor are turned on.

- i NOTE:** The computer BIOS must be configured to enable WOL function first.
- i NOTE:** This LAN port is 2.5GBase-T IEEE 802.3az compliant, supporting Mac Address (Printed on model label) Pass-thru (MAPT), Wake-on-LAN (WOL) from standby mode (S3) and UEFI* PXE Boot function [UEFI PXE Boot is not supported on Dell Desktop PC’s (except for OptiPlex 7090/3090 Ultra Desktop)], these 3 features depend on BIOS settings and operating system versions. The functionality may vary with non-Dell PCs.
*UEFI stands for Unified Extensible Firmware Interface.
- i NOTE:** WOL S4 and WOL S5 are only capable with Dell Systems that support DPBS and are with Thunderbolt/USB-C (MFDP) interface connection.
- i NOTE:** Any issue that is related to WOL, users should debug the computer without a monitor. After the problem is solved, then connect to the monitor.

RJ45 Connector LED status:

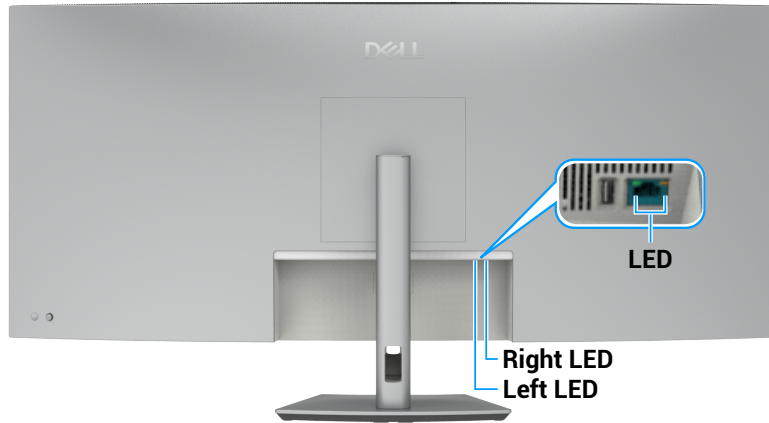

Figure 11. RJ45 LED color

Table 26. RJ45 LED color.

LED	Color	Description
Right LED	Amber or Green	Speed indicator: <ul style="list-style-type: none">• Amber On - 1000 Mbps/2.5 Gbps• Green On - 100 Mbps• Off - 10 Mbps
Left LED	Green	Link / Activity indicator: <ul style="list-style-type: none">• Blinking - Activity on the port.• Green On - Link is being established.• Off - Link is not established.

NOTE: RJ45 cable is not a standard in-box accessory.

Plug and Play

You can connect the monitor to any Plug and Play compatible computer. The monitor automatically provides the computer with its Extended Display Identification Data (EDID) using Display Data Channel (DDC) protocols so that the computer can configure itself and optimize the monitor settings. Most monitor installations are automatic; you can select different settings as required. For more information about changing the monitor settings, see [Operating the monitor](#).

LCD monitor quality and pixel policy

During the LCD monitor manufacturing process, it is not uncommon for one or more pixels to become fixed in an unchanging state, which are hard to see and do not affect the display quality or usability. For more information about Dell Monitor Quality and Pixel Policy, see [Dell Display Pixel Guidelines](#) at [Dell Support Site](#).

Ergonomics

△ **CAUTION:** Improper or prolonged usage of a keyboard may result in injury.

△ **CAUTION:** Viewing the monitor screen for extended periods of time may result in eye strain.

For comfort and efficiency, observe the following guidelines when setting up and using your computer workstation:

- Position your computer so that the monitor and keyboard are directly in front of you as you work. Special shelves are commercially available to help you correctly position your keyboard.
- To reduce the risk of eye strain and neck/arm/back/shoulder pain from using the monitor for long periods of time, we suggest you to:
 1. Set the distance of the screen between 20 in. to 28 in. (50 cm - 70 cm) from your eyes.
 2. Blink frequently to moisten your eyes or wet your eyes with water after prolonged usage of the monitor.
 3. Take regular and frequent breaks for 20 minutes every two hours.
 4. Look away from your monitor and gaze at a distant object at 20 feet away for at least 20 seconds during the breaks.
 5. Perform stretches to relieve tension in the neck, arm, back, and shoulders during the breaks.
- Make sure that the monitor screen is at eye level or slightly lower when you are sitting in front of the monitor.
- Adjust the tilt of the monitor, its contrast, and brightness settings.
- Adjust the ambient lighting around you (such as overhead lights, desk lamps, and the curtains or blinds on nearby windows) to minimize reflections and glare on the monitor screen.
- Use a chair that provides good lower-back support.
- Keep your forearms horizontal with your wrists in a neutral, comfortable position while using the keyboard or mouse.
- Always leave space to rest your hands while using the keyboard or mouse.
- Let your upper arms rest naturally on both sides.
- Ensure that your feet are resting flat on the floor.
- When sitting, make sure that the weight of your legs is on your feet and not on the front portion of your seat. Adjust your chair's height or use a footrest if necessary to maintain a proper posture.
- Vary your work activities. Try to organize your work so that you do not have to sit and work for extended periods of time. Try to stand or get up and walk around at regular intervals.
- Keep the area under your desk clear of obstructions and cables or power cords that may interfere with comfortable seating or present a potential trip hazard.

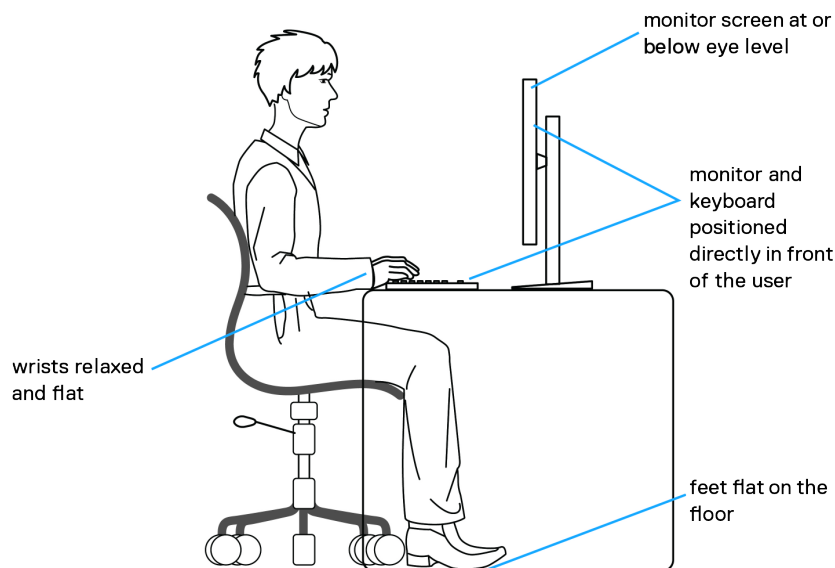

Figure 12. Ergonomics or comfort and efficiency

Handling and moving your monitor

To ensure the monitor is handled safely when lifting or moving it, follow the guidelines that are mentioned below:

- Before moving or lifting the monitor, turn off your computer and the monitor.
- Disconnect all cables from the monitor.
- Place the monitor in the original box with the original packing materials.
- Hold the bottom edge and the side of the monitor firmly without applying excessive pressure when lifting or moving the monitor.

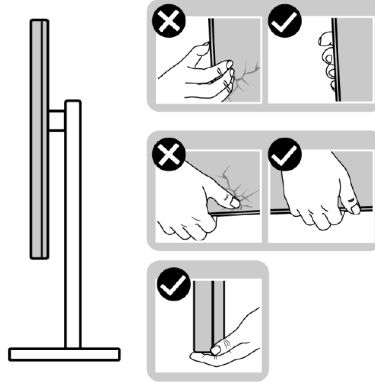

Figure 13. Moving or lifting the monitor

- When transporting the monitor, avoid any sudden shock or vibration to it.
- When lifting or moving the monitor, do not turn the monitor upside down while holding the stand base or stand riser. This may result in accidental damage to the monitor or cause personal injury.

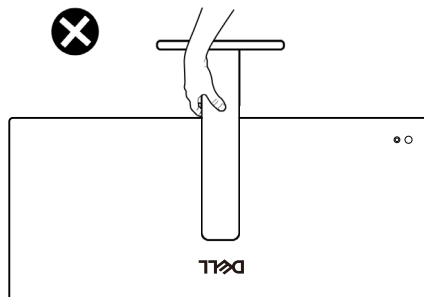

Figure 14. Do not turn the monitor upside down

Maintenance guidelines

Cleaning your monitor

⚠ WARNING: Before cleaning the monitor, unplug the monitor power cable from the electrical outlet.

⚠ CAUTION: Read and follow the [Safety instructions](#) before cleaning the monitor.

For best practices, follow the instructions in the list below when unpacking, cleaning, or handling your monitor:

- Use a clean cloth that is slightly dampened with water to clean the stand assembly, the screen, and the chassis of your Dell monitor. If available, use a screen-cleaning tissue or solution suitable for cleaning Dell monitors.
- After cleaning the surface of the table, ensure that it is thoroughly dry and free from any moisture or cleaning agent before placing your Dell monitor on it.
- ⚠ CAUTION:** Do not use detergents or other chemicals such as benzene, thinner, ammonia, abrasive cleaners, alcohol, or compressed air.
- ⚠ WARNING:** Do not directly spray the cleaning solution or even water directly on the surface of the monitor. Doing so will allow liquids to accumulate at the bottom of the display panel and corrode the electronics resulting in permanent damage. Instead, apply the cleaning solution or water to a soft cloth and then clean the monitor.
- ⚠ CAUTION:** Using chemicals for cleaning may cause changes in the appearance of the monitor, such as color fading, milky film on the monitor, deformation, uneven dark shade, and peeling of screen area.
- i NOTE:** Monitor damages due to improper cleaning methods and the use of benzene, thinner, ammonia, abrasive cleaners, alcohol, compressed air, detergent of any kind will lead to a Customer Induced Damage (CID). CID is not covered under the standard Dell warranty.
- If you notice white powder when you unpack your monitor, wipe it off with a cloth.
- Handle your monitor with care as a darker-colored monitor may get scratched and show white scuff marks more than a lighter-colored monitor.
- To help maintain the best image quality on your monitor, use a dynamically changing screen saver and turn off your monitor when not in use.

Setting up the monitor

Connecting the stand

- ① **NOTE:** The stand is not attached when the monitor is shipped from the factory.
- ① **NOTE:** The following instructions are applicable only for the stand that was shipped with your monitor. If you are attaching a stand that you purchased from any other source, follow the set up instructions that were included with the stand.

To connect the monitor stand:

1. Align and place the stand riser on the stand base.
2. Open the screw handle at the bottom of the stand base and turn it clockwise to secure the stand assembly.
3. Close the screw handle.

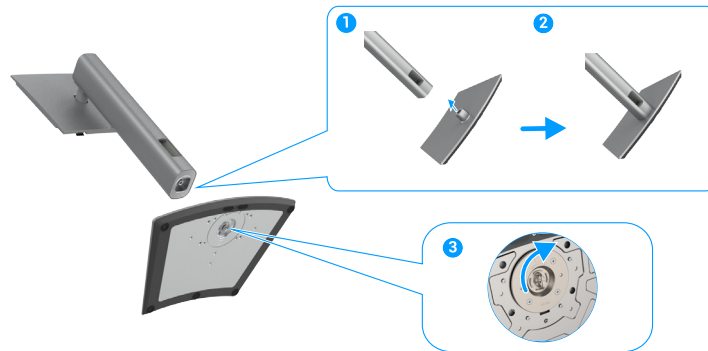

Figure 15. Connecting the stand

4. Open the protective cover on the monitor to access the VESA slot on the monitor. Carefully insert the tabs on the stand riser into the slots on the display back cover and press the stand assembly down to snap it into place.



Figure 16. Insert the tabs on the stand riser into the slots

5. Grip onto the dedicated hand slots and lift the inner corrugated tray with the monitor carefully, then place it upright on the stand base on a flat surface.

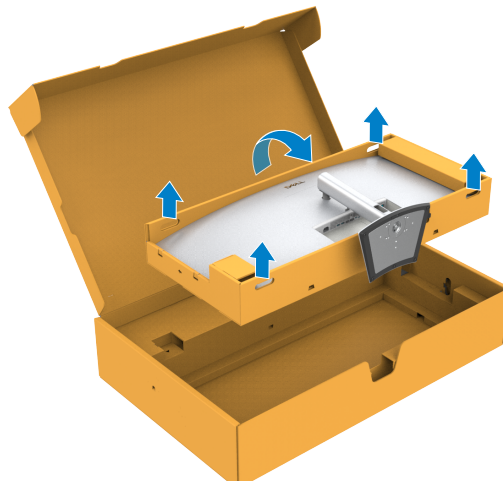

Figure 17. Grip onto the dedicated hand slots lift the inner corrugated tray



Figure 18. Place it upright on a flat surface

- ① **NOTE:** The monitor is very heavy, handle with extreme care. It is recommended to have two people to lift or move this monitor.
- ① **NOTE:** Grip onto the hand slots firmly when lifting the inner corrugated tray with monitor to avoid any accidental damage.
- 6. Remove the tapes, flip the side walls of the inner corrugated tray and slide it out from the monitor.

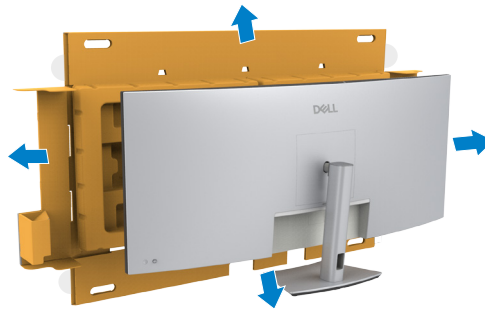

Figure 19. Remove the inner corrugated tray from the monitor

Using the tilt, swivel, vertical extension, and slant adjust

NOTE: The following instructions are applicable only for the stand that was shipped with your monitor. If you are attaching a stand that you purchased from any other source, follow the set up instructions that were included with the stand.

Tilt, swivel and vertical extension

With the stand that is attached to the monitor, you can tilt and swivel the monitor for the most comfortable viewing angle.

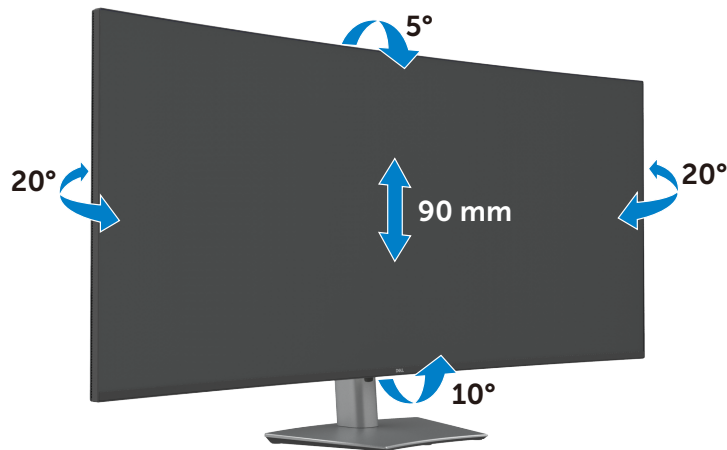

Figure 20. Tilt, swivel and vertical extension

NOTE: The stand is detached when the monitor is shipped from the factory.

Slant adjust

With the stand attached to the monitor, you can adjust the monitor to your desired angle with the slant adjust feature.



Figure 21. Slant adjust

Organizing your cables



Figure 22. Organizing your cables

When connecting the necessary cables route the cables through the cable-management slot. For more information, see [Connecting your monitor](#).

If your cable is not able to reach your computer, you may connect directly to the computer without routing through the slot on the monitor stand.

Wall Mounting/3rd Party Arm (Optional)

① **NOTE:** Wall Mount Kit/3rd Party Arm Kit is NOT included in this monitor.

△ **CAUTION:** Do not remove the monitor from the packaging box before attaching the mounting bracket from the Wall Mount Kit/3rd Party Arm Kit.

Refer to the instructions that come with the VESA-compatible wall mounting bracket.

1. Attach the mounting bracket onto the monitor and then lift the inner corrugated tray with the monitor out of the packaging box.

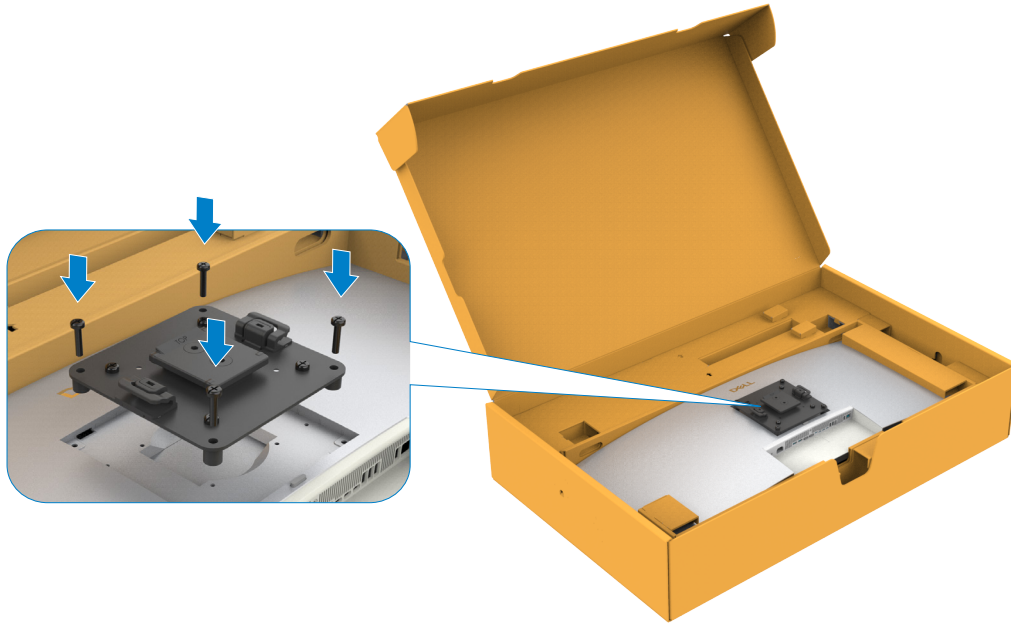

Figure 23. Attach the mounting bracket

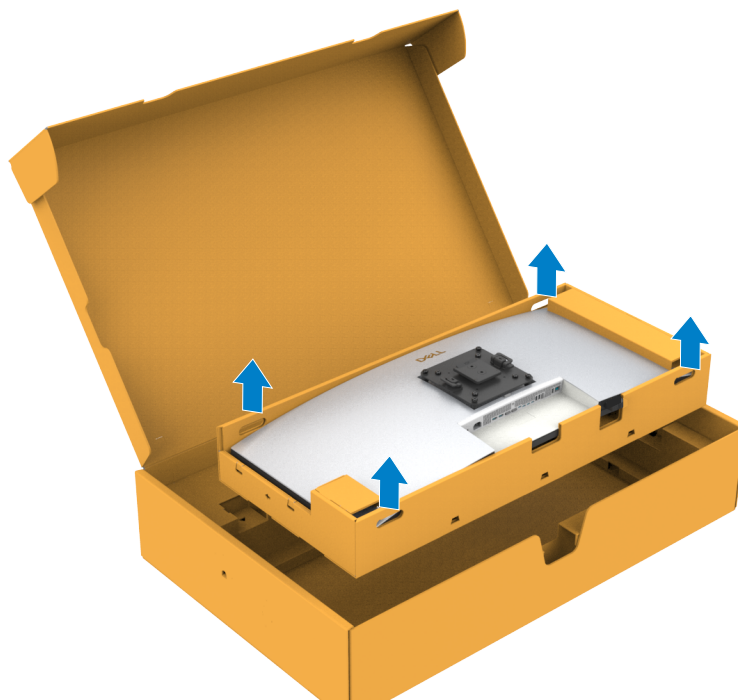

Figure 24. Lift the inner corrugated tray

2. While gripping onto the inner corrugated tray, attach the monitor to the 3rd party arm (follow the 3rd Party Arm/Wall mount Installation instructions).

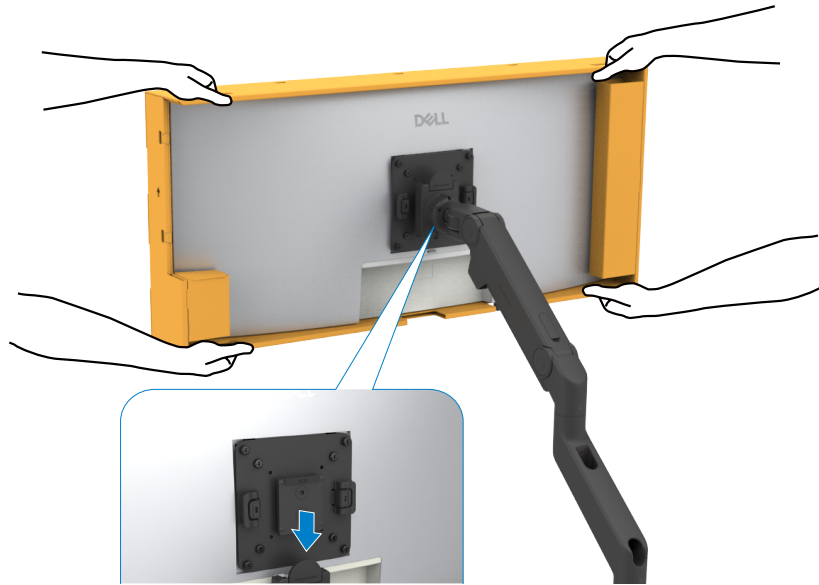

Figure 25. Attach the monitor to the Wall Mount/3rd Party Arm

- ① **NOTE:** The monitor is very heavy; handle with extreme care. It is recommended to have two people to lift or move this monitor.
3. Remove the tapes from the four corners of the inner corrugated tray and slide the inner corrugated tray out from the monitor.

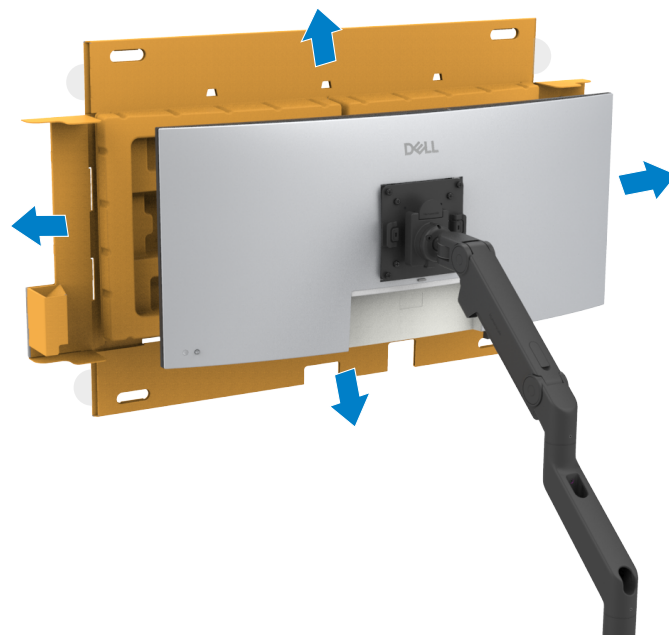

Figure 26. Remove the inner corrugated tray from the monitor

4. When using as dual monitor stacked on top of each other, set up must comply to the recommended panel orientation and working angle.
- ① **NOTE:** In double stacked scenario using 3rd Party Arm, the top monitor should not be rotated 180° (landscape). The monitors should not be orientated at 90° (portrait).

Connecting your monitor

- ⚠ **WARNING:** Before you begin any of the procedures in this section, follow the [Safety instructions](#).
- ⚠ **WARNING:** For your safety, ensure that the grounded power outlet you plug the power cable into is accessible to the operator and located as close to the equipment as possible. To disconnect power from the equipment, unplug the power cable from the power outlet by grasping the plug firmly. Never pull on the cord.
- ℹ **NOTE:** Dell monitors are designed to work optimally with the Dell-supplied cables inside the box. Dell does not guarantee the video quality and performance if non-Dell cables are used.
- ℹ **NOTE:** Route the cables through the cable-management slot before connecting them.
- ℹ **NOTE:** Do not connect all the cables to the computer at the same time.
- ℹ **NOTE:** The images are for the purpose of illustration only. The appearance of the computer may vary.

To connect your monitor to the computer:

1. Turn off your computer and disconnect the power cable.
 2. Connect the HDMI/DisplayPort/Thunderbolt 4 cable from your monitor to the computer.
- ⚠ **CAUTION:** Before using the monitor, it is recommended to fasten the stand riser to a wall using cable tie or a cord that can support the weight of monitor in order to prevent the monitor from falling.

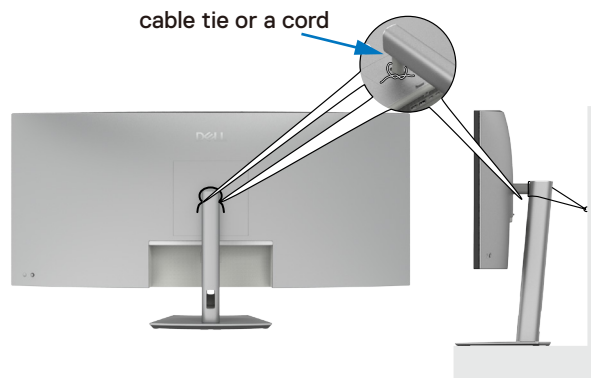

Figure 27. Prevent the monitor from falling

3. Turn on your monitor.
 4. Select the correct input source from the OSD Menu on your monitor and then turn on your computer.
- ℹ **NOTE:** U5226KW default setting is DisplayPort 1.4. A DisplayPort 1.1 Graphic card may not display normally. Please refer to [Product specific problems – No image when using DP connection to the PC](#) to change default setting.
 - ℹ **NOTE:** Remove the rubber plug when using USB-C upstream connector.

Connecting the HDMI cable

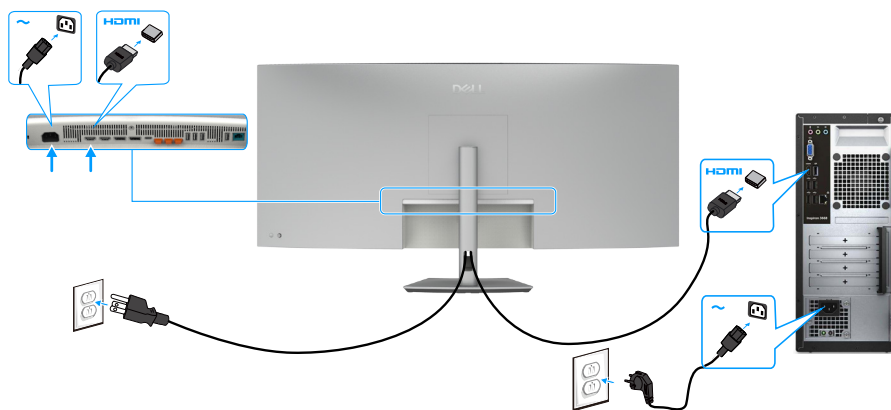

Figure 28. Connecting the HDMI cable

Connecting the DisplayPort cable

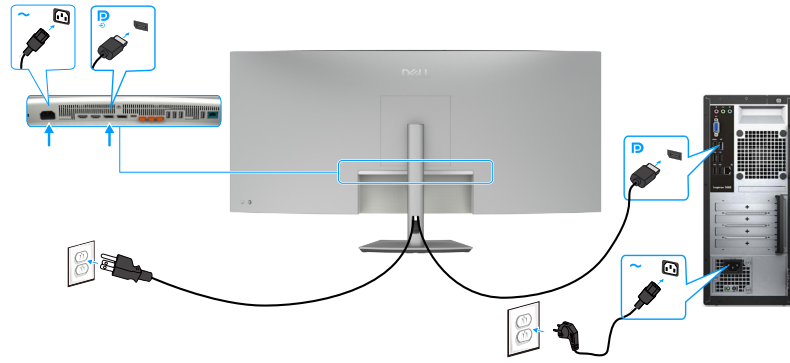

Figure 29. Connecting the DisplayPort cable

Connecting the Thunderbolt 4 cable

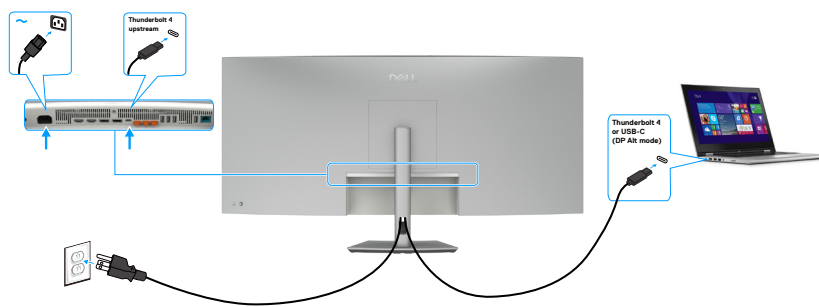

Figure 30. Connecting the Thunderbolt 4 cable

Connecting the USB-C cable (A to C)

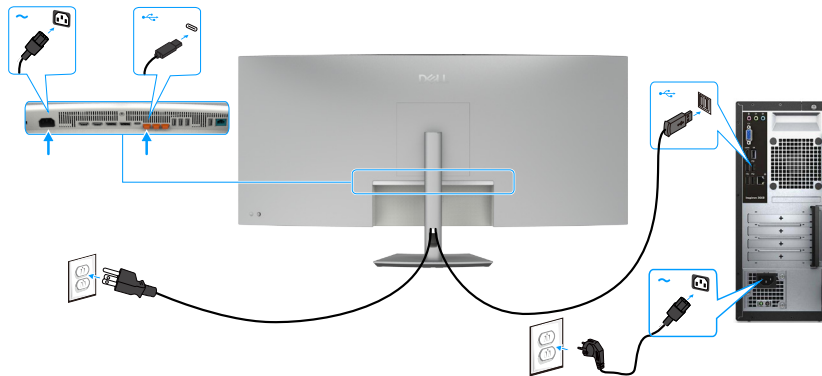

Figure 31. Connecting the USB-C cable (A to C)

NOTE: This connection supports data only and does not transmit video. An additional video connection for display is needed.

Connecting the USB-C cable (C to C) (Optional)

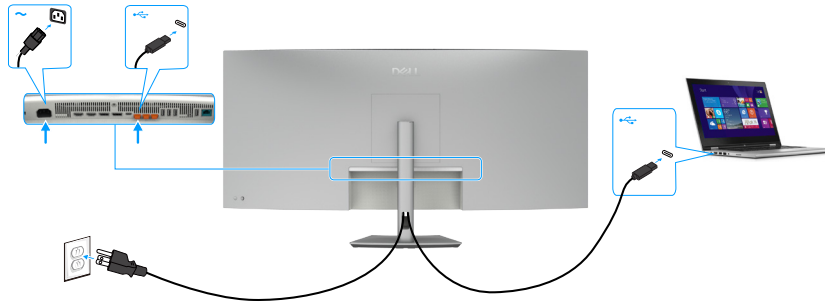

Figure 32. Connecting the USB-C cable (C to C) (Optional)

- NOTE:** This connection only data is available and no video. Need another video connection for display.
- NOTE:** Regardless of the power requirement/actual power consumption of your laptop, or the remaining power runtime in your battery, the Dell monitor is designed to supply power delivery of up to 140 W to your laptop.

Table 27. Power Delivery.

Rated power (on laptops that have USB-C with Power Delivery)	Maximum charging power
45 W	45 W
60 W	60 W
90 W	90 W
140 W	*140 W

*For laptops that supports EPR 140 W charging.

WARNING: The Dell UltraSharp U5226KW supports the USB-C Power Delivery 3.1 (Thunderbolt 4) specification and can provide a maximum output of up to 140 W. For safety consideration, this USB-C port must be connected to the Dell-approved products with the inbox Thunderbolt 4 Active cable. For the list of Dell-approved products, refer Dell products compatible with USB-C Power Delivery 3.1 (Extended Power Range 140W) Tech sheet at Dell.com/support/U5226KW.

Connecting the monitor for RJ45 cable, LAN access via monitor network port (Optional)

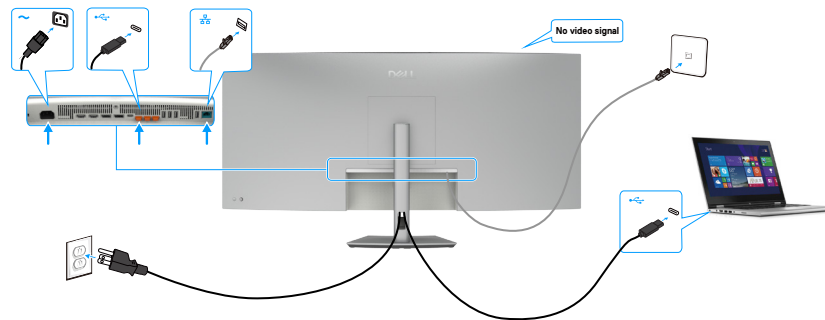

Figure 33. Network routing via USB-C upstream port

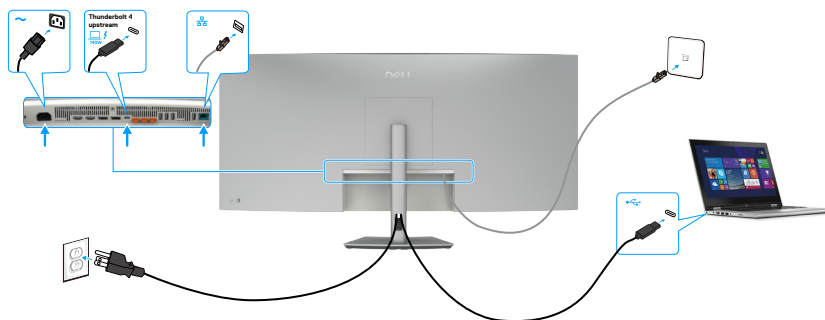

Figure 34. Network routing via Thunderbolt 4 upstream port

Dell Power Button Sync (DPBS)

The monitor is designed with Dell Power Button Sync (DPBS) feature to allow you to control computer power state from the monitor power button. This feature is only supported with Dell platform which has built-in DPBS function, and is only supported over Thunderbolt 4 interface.

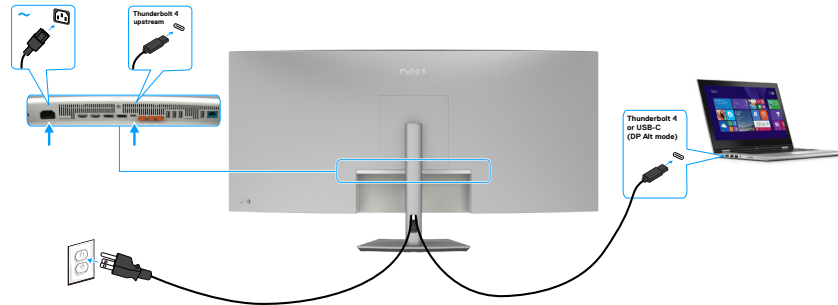

Figure 35. Connecting the Thunderbolt 4 cable

To make sure the DPBS function works for the first time, perform the following steps on the DPBS supported platform in the **Control Panel** first.

NOTE: DPBS only supports the port with  icon.

1. Go to **Control Panel**.

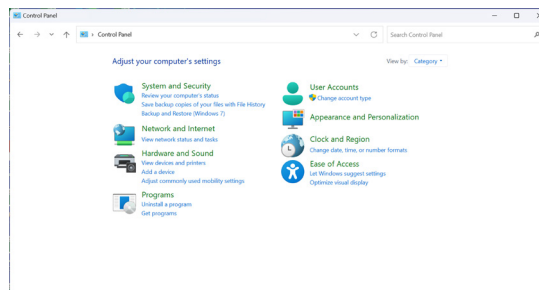

Figure 36. Dell Power Button Sync-Control Panel

2. Select **Hardware and Sound**, followed by **Power Options**.

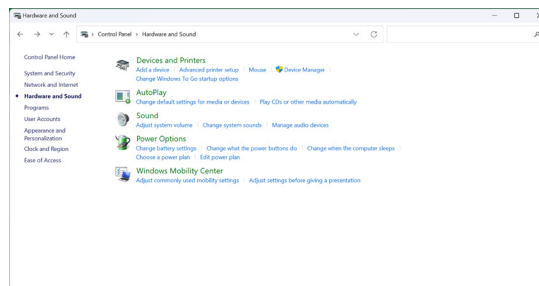

Figure 37. Dell Power Button Sync-Hardware and Sound

3. Go to **System Settings**.

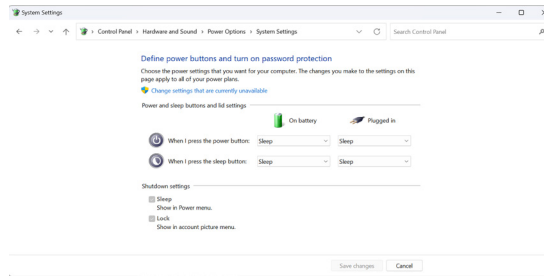

Figure 38. Dell Power Button Sync-system settings

4. Select the preferred options from **When I press the power button**.

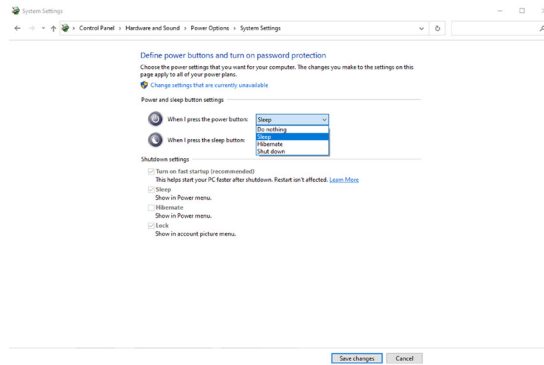

Figure 39. Dell Power Button Sync-Power button settings

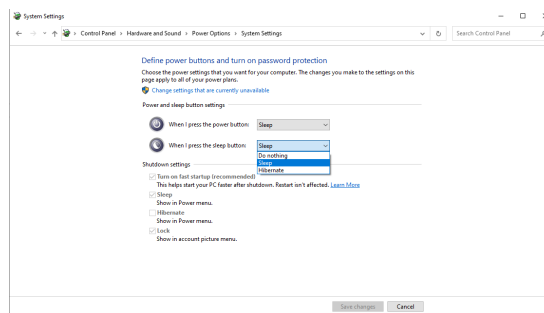

Figure 40. Dell Power Button Sync-Sleep button settings

NOTE: Do not select **Do nothing**, otherwise monitor power button cannot sync with computer power state.

Connecting the monitor for DPBS for the first time

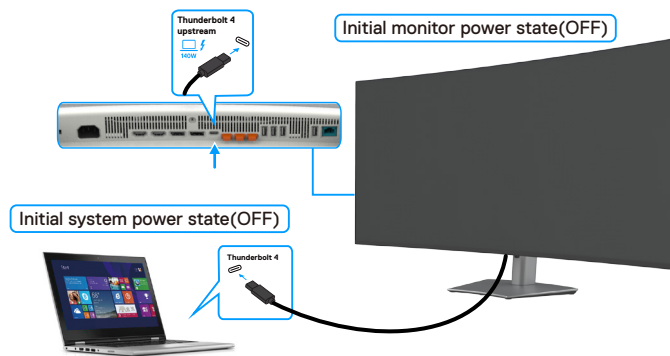

Figure 41. Dell Power Button Sync-Connecting for the first time

Perform the following steps when setting up the DPBS function for the first time:

1. Navigate to **Dell Power Button Sync** in sub menu under **Display** and enable it.
2. Ensure both the computer and the monitor are turned **OFF**.
3. Connect the Thunderbolt 4 cable from the computer to the monitor.
4. Press the monitor power button to turn ON the monitor.
5. Both the monitor and computer will turn ON momentarily. If not, press either the monitor power button or computer power button to boot up the system.
6. When you connect the Dell OptiPlex 7090/3090 Ultra platform, you may see both the monitor and computer will turn ON momentarily. Wait for a while (approximately 6 seconds) and both the PC and monitor will turn OFF. When you press either the monitor power button or computer power button, both the computer and monitor will turn ON. The computer system power state is in sync with the monitor power button.

i NOTE: When the monitor and computer are both at power OFF state at first time, it is recommended that you turn ON the monitor first, then connect the Thunderbolt 4 cable from the computer to the monitor.

i NOTE: You can power the Dell PC* Ultra platform using its DC adaptor jack. Alternatively, you can power the Dell computer* Ultra platform using the monitor's Thunderbolt 4 cable via Power Delivery (PD); please set USB-C Charging (140W) to On in Off Mode.

* Ensure to check the Dell computer for DPBS supportability.

Using DPBS function

When you connect the Thunderbolt 4 cable, the monitor/computer state is as follows:

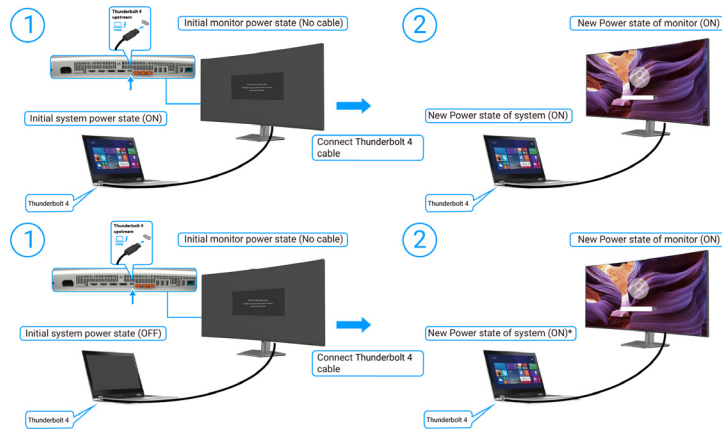

Figure 42. Dell Power Button Sync-Connect the Thunderbolt 4 cable

*Not all Dell computers support to wake up the platform through the monitor.

*Upon USB-C cable connection, mouse movement or keyboard press might be required to wake the computer/monitor up from sleep or hibernate.

When you press the monitor power button or computer power button, the monitor/computer state is as follows:

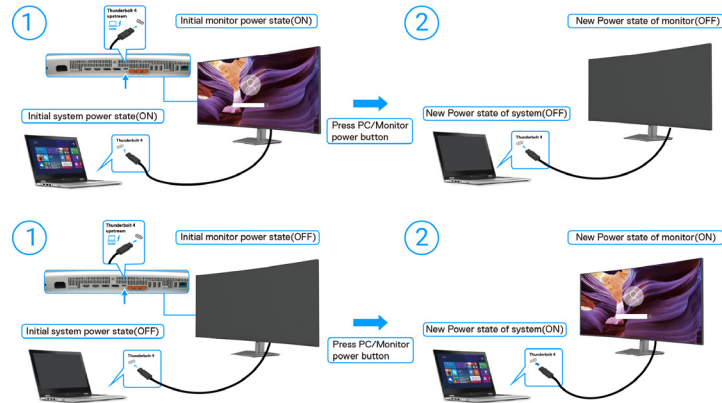

Figure 43. The state of the monitor/computer

NOTE: You can enable or disable the power button sync function using the OSD. See [Dell Power Button Sync](#).

When the monitor and computer power state are both ON, while you **press and hold 4 seconds on monitor power button**, the screen prompt will ask if you would like to shut down the computer.

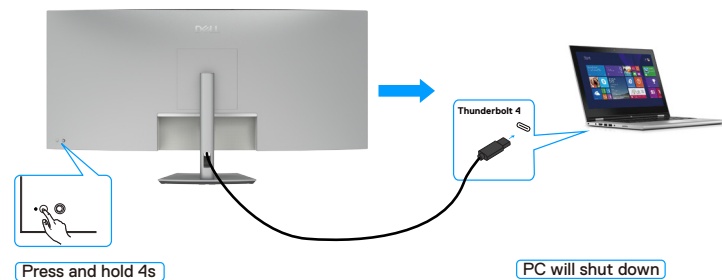

Figure 44. Press and hold 4 seconds on monitor power button

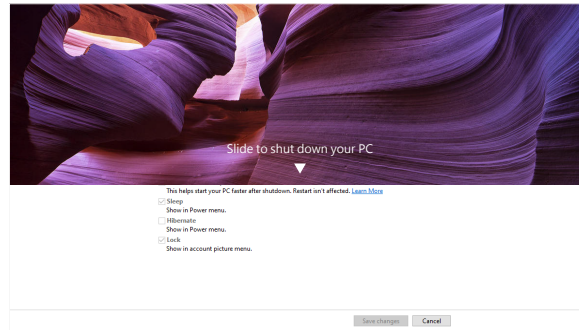

Figure 45. Slide to shut down your computer

When the monitor and computer power state are both ON, while **you press and hold 10 seconds on monitor power button**, the computer will shut down.

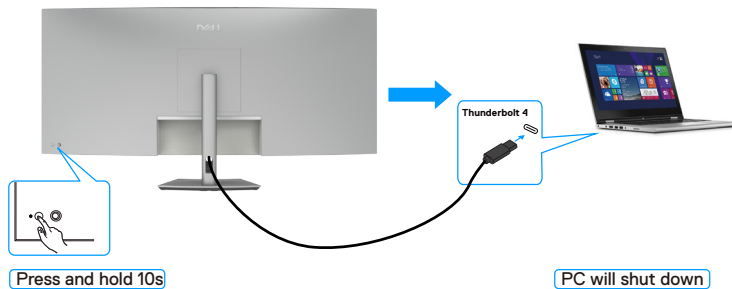

Figure 46. Press and hold 10 seconds on monitor power button

Connect multiple Thunderbolt 4 monitors to one system

The Dell computer* Ultra platform has two Thunderbolt 4 ports, so both Monitor 1 and Monitor 2 power state can sync with the computer.

While the computer and two monitors are in an initially ON power state, by pressing the power button on Monitor 1 or Monitor 2 will turn OFF the computer, Monitor 1, and Monitor 2.

* Ensure to check the Dell computer for DPBS supportability.

i NOTE: DPBS only supports the port with  icon.

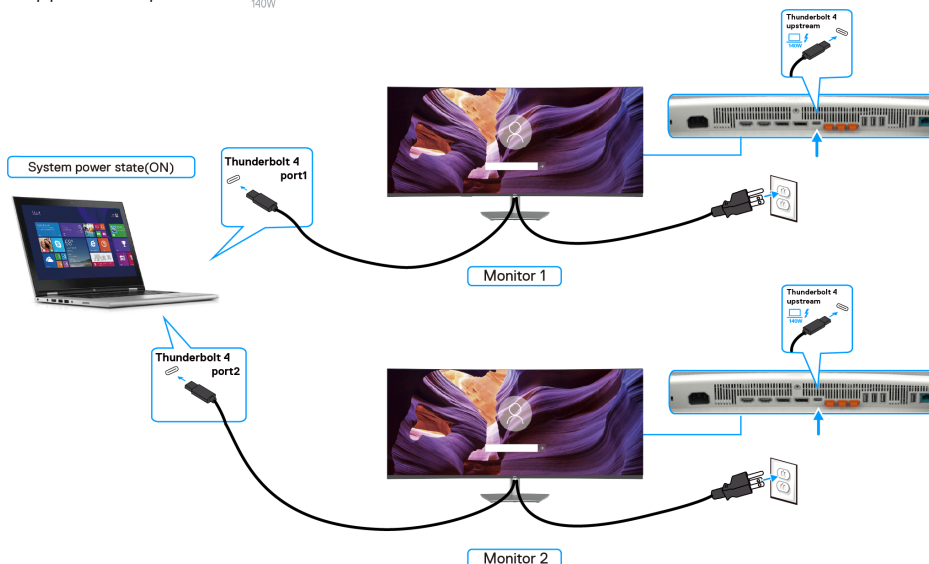

Figure 47. Two monitors power state can sync with the computer in DPBS mode

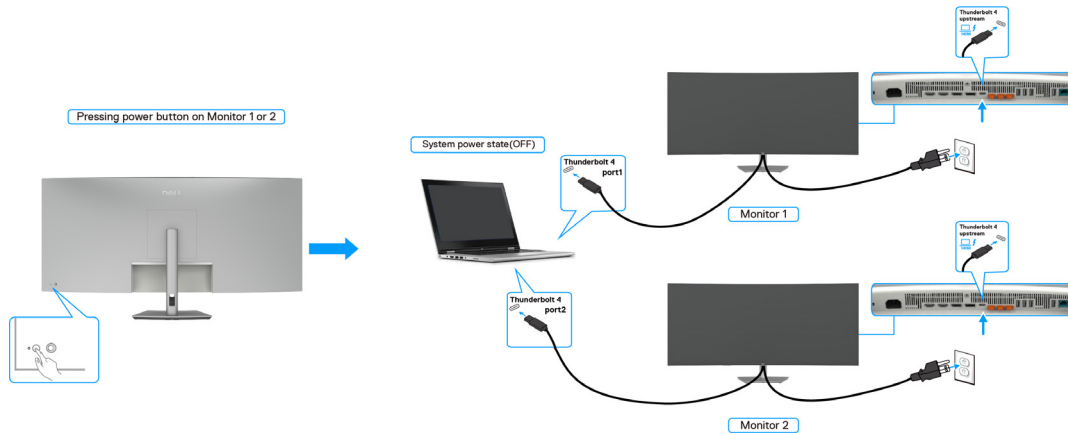

Figure 48. Pressing the power button on either monitor will turn off both monitors and the computer

Make sure to set **Thunderbolt 4** to On in Off Mode. While the computer and two monitors are in an initially OFF power state, by pressing the power button on Monitor 1 or Monitor 2 will turn ON the computer, Monitor 1, and Monitor 2.

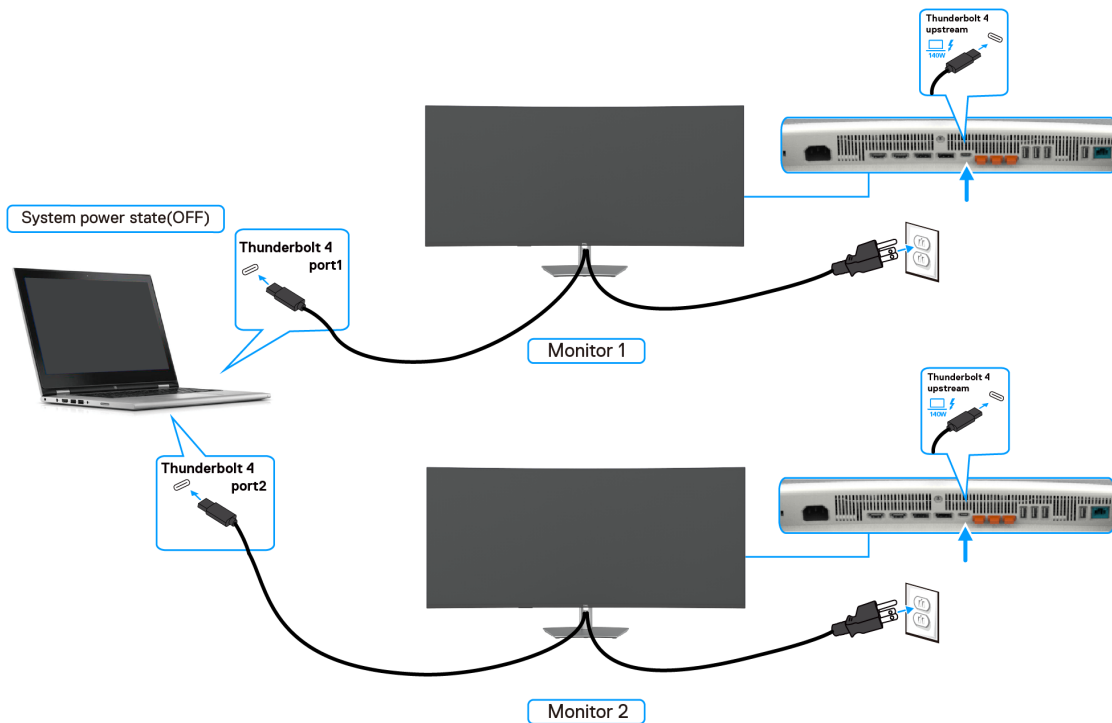

Figure 49. Two monitors and computer power state Off in DPBS mode

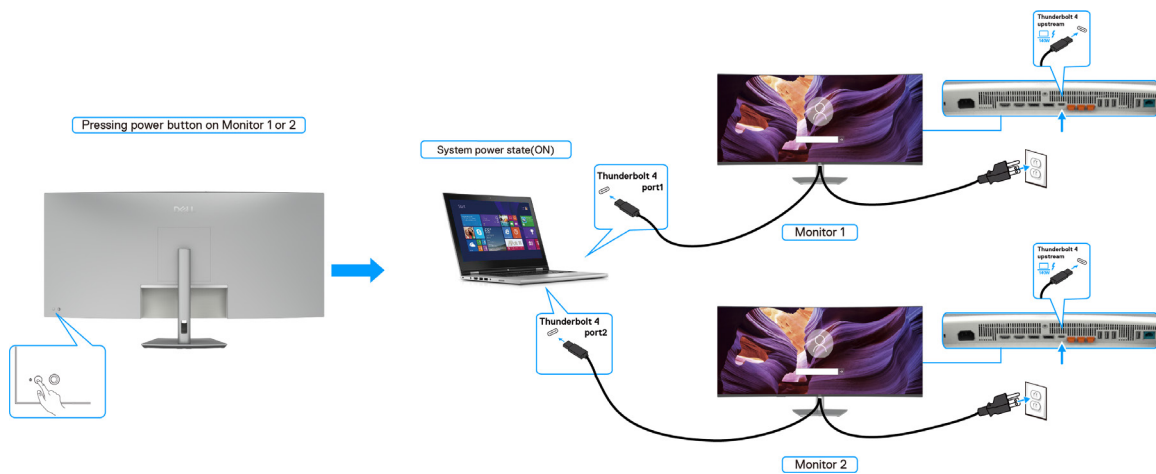

Figure 50. Two monitors and computer power state On in DPBS mode

Securing your monitor using Kensington lock (optional)

The security lock slot is located at the bottom of the monitor (see [security lock slot](#)). Secure your monitor to a table using the Kensington security lock.

For more information on using the Kensington lock (sold separately), see the documentation that is shipped with the lock.

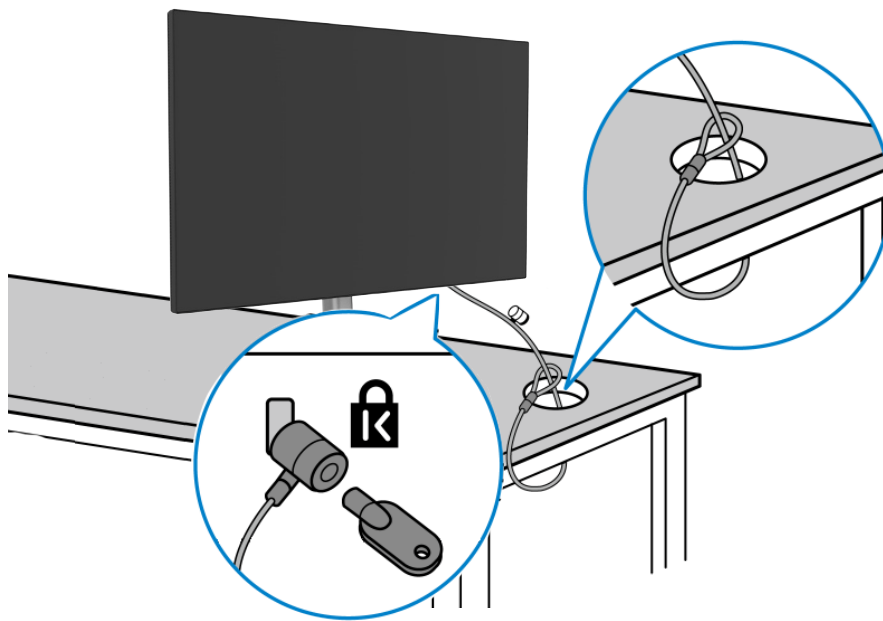

Figure 51. Kensington_Noble lock

NOTE: The image is for the purpose of illustration only. The appearance of the lock may vary.

Removing the monitor stand

CAUTION: To prevent scratches on the LCD screen when removing the stand, ensure that the monitor is placed on a soft surface and handle it carefully.

NOTE: The following steps are specifically for removing the stand that is shipped with your monitor. If you are removing a stand that you purchased from any other source, follow the setup instructions that are included with the stand.

To remove the stand:

1. Place the monitor on a soft cloth or cushion.
2. Press and hold the stand-release button.
3. Lift the stand up and away from the monitor.

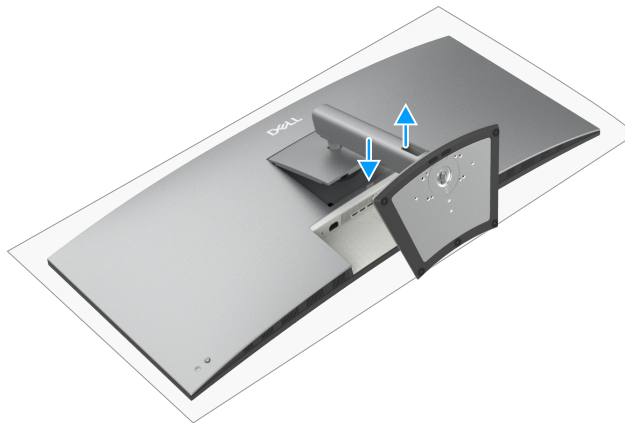

Figure 52. Removing the monitor stand

VESA wall mounting (optional)

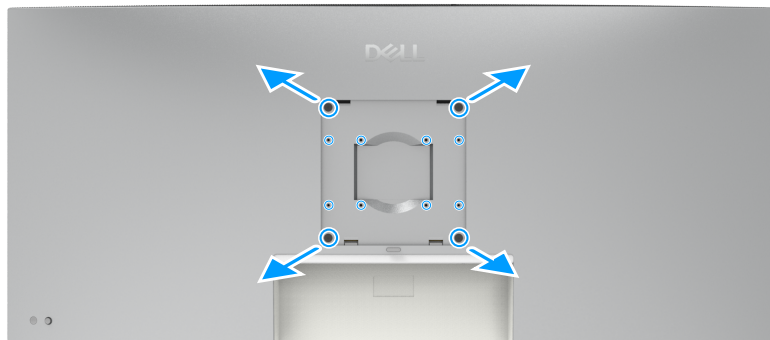

Figure 53. VESA wall mounting (optional)

NOTE: Use M6 x 12 mm screws to connect the monitor to the 200 mm x 200 mm wall-mounting kit. Use M4 x 10 mm screws to connect the monitor to the 200 mm x 100 mm or 100 mm x 100 mm wall-mounting kit.

Refer to the instructions that come with the VESA-compatible wall mounting kit.

1. Place the monitor on a soft cloth or cushion on a stable flat table.
2. Remove the stand (See [Removing the monitor stand](#)).
3. Use a Phillips crosshead screwdriver to remove the four screws securing the plastic cover.
4. Attach the mounting bracket from the wall-mounting kit to the monitor.
5. Mount the monitor on the wall. For more information, see the documentation that is shipped with the wall-mounting kit.

NOTE: For use only with UL or CSA or GS-listed wall mount bracket with minimum weight or load bearing capacity of 51.80 kg (114.28 lb).

Operating the monitor

Turn on the monitor

Press the power button to turn on the monitor.

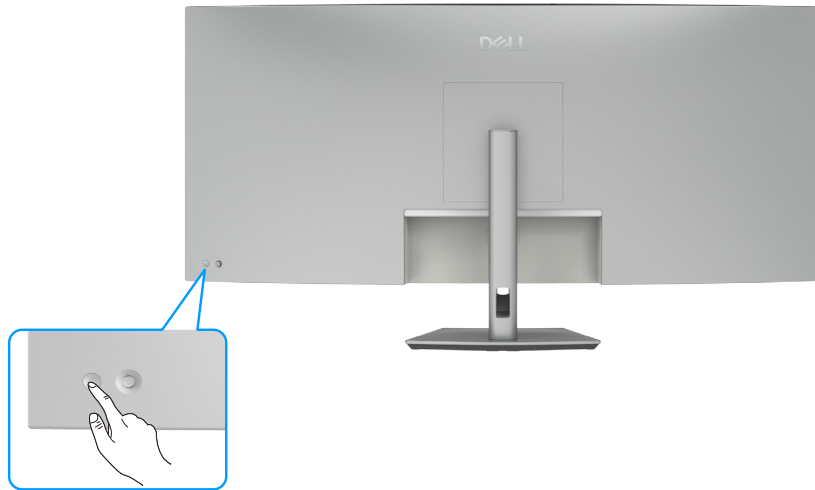

Figure 54. Power on the monitor

Using the joystick control

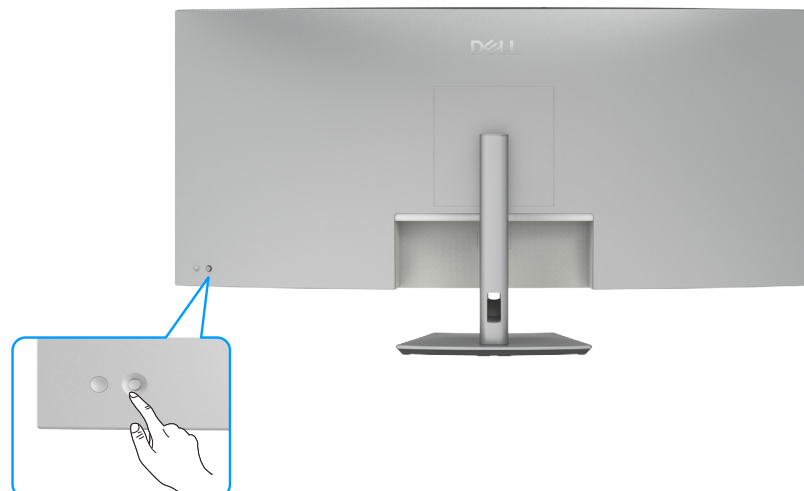





Figure 55. Using the joystick control

To modify the OSD adjustments using the joystick control on the rear end of the monitor, do the following:

1. Press the joystick to open the OSD Menu Launcher.
2. Move the joystick up/down/left/right to toggle between the OSD menu options.

Joystick functions

Table 28. Joystick functions.

Function	Description
	Press Joystick to open the OSD Menu Launcher.
	For right and left navigation.
	For up and down navigation.

Using the Menu Launcher

Press the Joystick to open the OSD Menu Launcher.

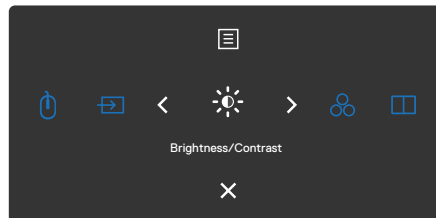









Figure 56. Menu Launcher

- Toggle the Joystick **Up** to open the **Main Menu**.
- Toggle the Joystick **Left** or **Right** to select the desired **Shortcut Keys**.
- Toggle the Joystick **Down** to **Exit**.

Menu Launcher details

The following table describes the Menu Launcher icons:

Table 29. Menu Launcher description.

Menu Launcher icon	Description
 Main Menu	Opens the On-Screen Display (OSD). See Using the main menu .
 USB Switch (Shortcut key 1)	In PBP/PIP mode, you can switch USB between the main and secondary screens.
 Input Source (Shortcut key 2)	Sets the Input Source .
 Brightness/Contrast (Shortcut key 3)	To directly access the Brightness/Contrast adjustment sliders.
 Preset Modes (Shortcut key 4)	Allows to choose from a list of Preset color modes .
 PIP/PBP Mode (Shortcut key 5)	Use this button to choose from a list of PIP/PBP .
 Exit	Exits from the OSD main menu.

Using the navigation keys

When the OSD main menu is active, move the joystick to configure the settings, following the navigation keys displayed below the OSD.

NOTE: To exit the current menu item and return to the previous menu, move the joystick to the left until you exit.

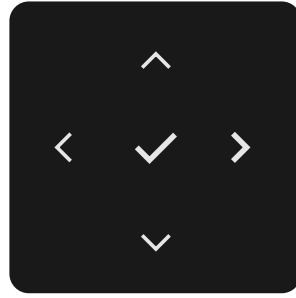







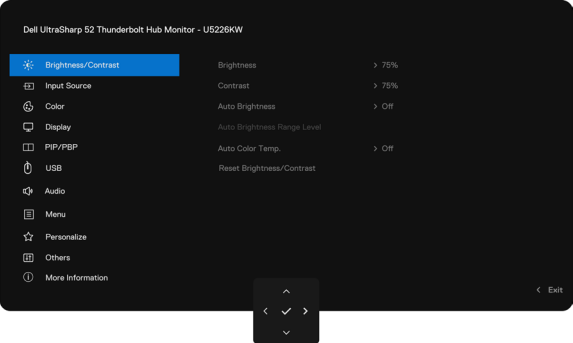

Figure 57. Navigation keys

Table 30. Navigation keys description.



Front panel	Description
1  Up  Down	Use the Up (increase) and Down (decrease) navigation keys to adjust items in the OSD menu.
2  Left	Use the Left navigation key to go back to the previous menu.
3  Right	Use the Right navigation key to confirm your selection.
4  OK	Press the joystick to confirm your selection.

Using the Main Menu

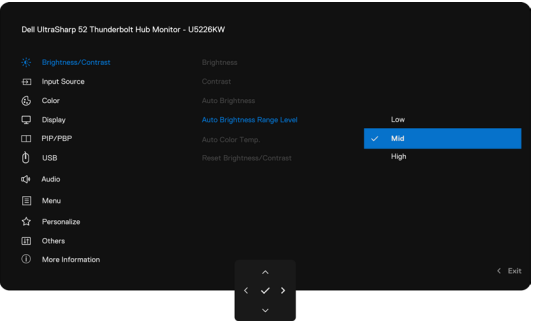
Table 31. Main Menu description.

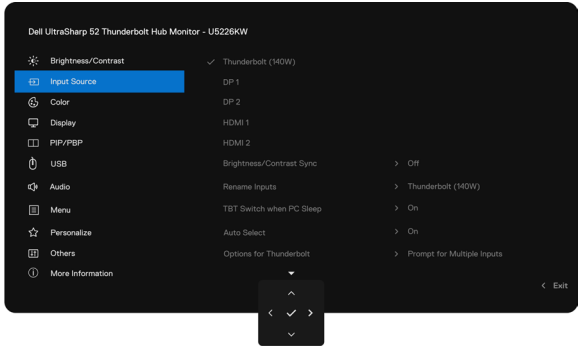
Icon	Menu and Submenus	Description
	Brightness/ Contrast	Adjust the Brightness, Contrast, Auto Brightness, Auto Brightness Range Level, Auto Color Temp. and Reset Brightness/ Contrast functions. 
	Brightness	Adjusts the luminance of the backlight (Range: 0 - 100). Move the Joystick Up to increase brightness. Move the Joystick Down to decrease brightness.
	Contrast	Adjust the Brightness first, and then adjust Contrast only if further adjustment is necessary. Move the Joystick Up to increase contrast and Move the Joystick Down to decrease contrast (Range: 0 - 100). The Contrast function adjusts the degree of difference between darkness and lightness on the monitor screen.
	Auto Brightness	Turns on the Auto Brightness and adjusts the monitor brightness setting according to the ambient light.
	Auto Brightness Range Level	When Auto Brightness is turned on, adjust the range level of the Auto Brightness.  NOTE: When Auto Brightness is turned off, this function is not available. 
	Auto Color Temp.	Turns on Auto Color Temp and adjusts the monitor RGB color settings in accordance with the ambient light.
	Reset Brightness/ Contrast	Resets all settings under the Brightness/ Contrast menu to the factory defaults.

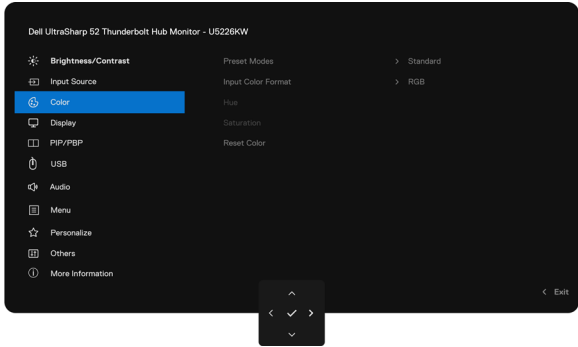
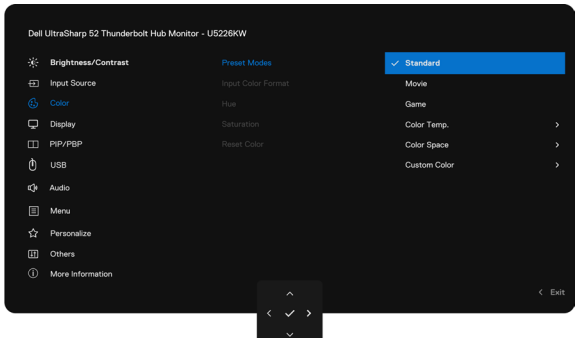
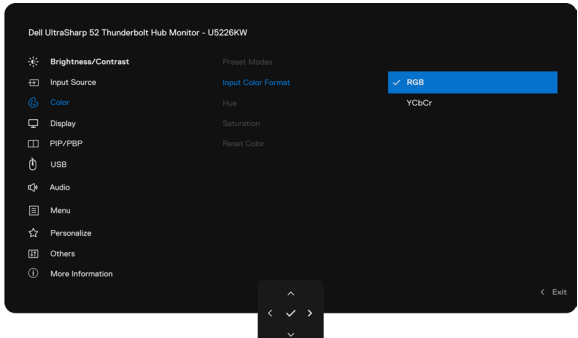
Icon	Menu and Submenus	Description
	Input Source	Selects between different video inputs that are connected to your monitor. 
	Thunderbolt (140 W)	Select Thunderbolt (140W) input when you are using the Thunderbolt (140 W) connector. Press the joystick button to confirm the selection.
	DP 1	Select DP input when you are using the DP (DisplayPort) connector. Press the Joystick button to confirm the selection.
	DP 2	Select DP input when you are using the DP (DisplayPort) connector. Press the Joystick button to confirm the selection.
	HDMI 1	Select the HDMI input when you are using the HDMI connector. Press the Joystick button to confirm the selection.
	HDMI 2	Select the HDMI input when you are using the HDMI connector. Press the Joystick button to confirm the selection.
	Brightness/ Contrast Sync	Select ON to apply unified Brightness and Contrast level to all input sources. Select OFF to have independent Brightness and Contrast settings.
	Rename Inputs	Allows you to Rename Inputs .
	TBT Switch when PC Sleep	Select ON: When TBT PC enter Sleep mode, it allows Monitor switching to another input sources. Select OFF: When TBT PC enter Sleep mode, it keeps the Monitor connection until TBT cable is unplugged.
	Auto Select	Allows you to scan for available input sources. Press the joystick to select this function.
	Option for Thunderbolt	Press the joystick to select these functions: <ul style="list-style-type: none"> • Prompt for Multiple Inputs: Always show Switch to Thunderbolt Video Input message for user to choose whether to switch or not. • Always Switch: The monitor always switches to Thunderbolt video by default while Thunderbolt is connected. • Off: The monitor does not auto-switch to Thunderbolt video from another available input.
	Option for DP/ HDMI	Press the joystick to select these functions: <ul style="list-style-type: none"> • Prompt for Multiple Inputs: Always show Switch to DP/HDMI Video Input message for user to choose whether to switch or not. • Always Switch: The monitor always switches to DP/HDMI video by default while DP/HDMI is connected. • Off: The monitor does not auto-switch to DP/HDMI video from another available input.
	Reset Input Source	Resets all settings under the Input Source menu to the factory defaults. Press the joystick to select this function.

Icon	Menu and Submenus	Description
	Color	Adjusts the color setting mode. 
	Preset Modes	When you select Preset Modes, you can choose Standard , Movie , Game , Color Temp. , Color Space or Custom Color from the list.  <ul style="list-style-type: none"> • Standard: Default Color setting, this monitor uses a low blue light panel, and is certified by TUV to reduce blue light output and create a more relaxing and less stimulating image while reading content on the screen. • Movie: Ideal for movies. • Game: Ideal for most gaming applications. • Color Temp.: The screen appears warmer with a red/yellow tint with slider set at 5,000K or cooler with blue tint with slider set at 10,000K. • Color Space: Allows users to select the color space: sRGB, BT.709, DCI-P3, Display P3. • Custom Color: Allows you to manually adjust the color settings. Press the Joystick left and right buttons to adjust the Red, Green, and Blue values and create your own preset color mode.
	Input Color Format	Allows you to set the video input mode to: <ul style="list-style-type: none"> • RGB: Select this option if your monitor is connected to a computer or a media player that supports RGB output. • YCbCr: Select this option if your media player supports only YCbCr output. 
	Hue	Use Joystick Up or Down to adjust the Hue from 0 to 100.  NOTE: Hue adjustment is available only for Movie and Game mode.

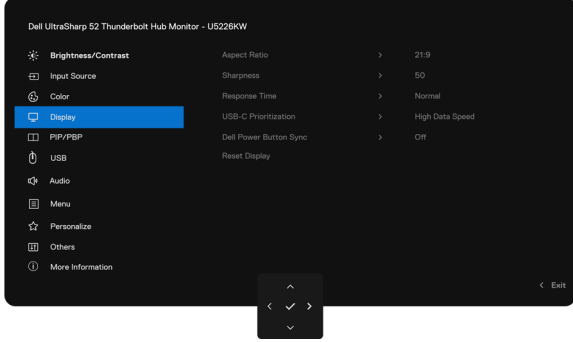

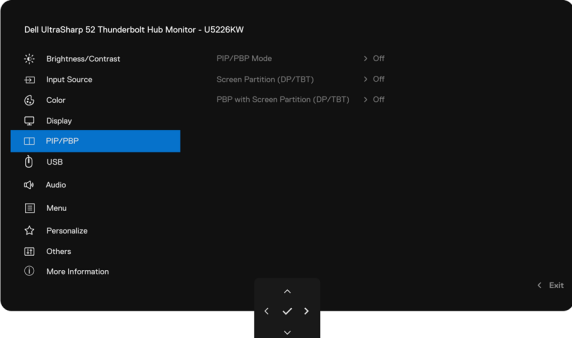
Icon	Menu and Submenus	Description
	Saturation	Use Joystick Up or Down to adjust the Saturation from 0 to 100. i NOTE: Saturation adjustment is available only for Movie and Game mode.
	Reset Color	Resets your monitor's color settings to the factory defaults. Press the joystick to select this function.
	Display	Use the Display menu to adjust image. 
	Aspect Ratio	Adjust the image ratio to 21:9, 16:9, 4:3, 1:1, Auto Resize .
	Sharpness	Makes the image look sharper or softer. Move the Joystick up and down to adjust the sharpness from '0' to '100'.
	Response Time	Allows you to set the Response Time to Normal or Fast .
	USB-C Prioritization	Allows you to specify the priority to transfer the data with high resolution (High Resolution) or high speed (High Data Speed) when using the TBT port (DP ALT mode). i NOTE: If you are connecting to a Thunderbolt video signal source, this option is disabled. This option is only enabled if you are connecting to a USB-C video signal source.
	Dell Power Button Sync	To allow you to control PC system power state from the monitor power button. Allows you to On or Off Dell Power Button Sync function. i NOTE: This feature is only supported with Dell platform which has built-in DPBS function, and is only supported over Thunderbolt interface.
	Reset Display	Resets all settings under the Display menu to the factory defaults. Press the joystick to select this function.

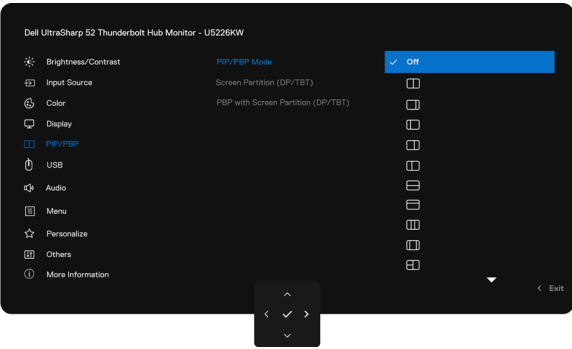

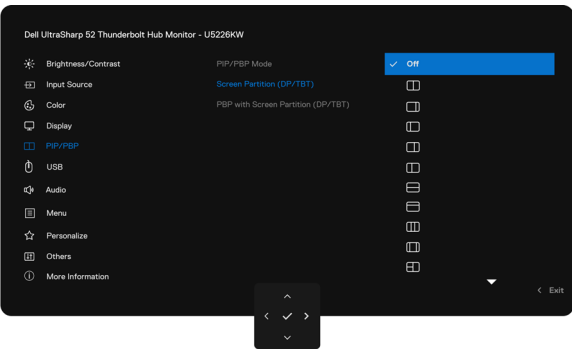

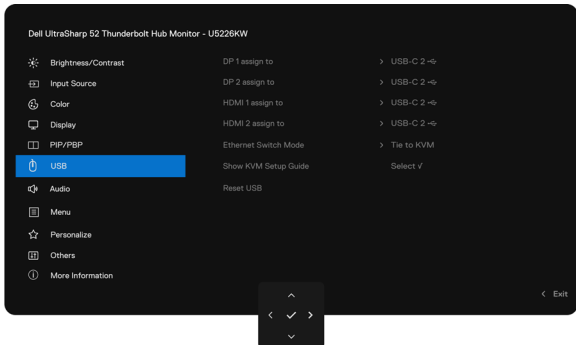
Icon	Menu and Submenus	Description																																									
	PIP/BBP	<p>This function brings up a window displaying image from another input source.</p>  <table border="1" data-bbox="399 616 1212 884"> <thead> <tr> <th rowspan="2">Main Window (left / top / left top)</th> <th colspan="5">Sub (right / bottom) Window</th> </tr> <tr> <th>Thunderbolt</th> <th>DP 1</th> <th>DP 2</th> <th>HDMI 1</th> <th>HDMI 2</th> </tr> </thead> <tbody> <tr> <td>Thunderbolt</td> <td>√</td> <td>√</td> <td>√</td> <td>√</td> <td>√</td> </tr> <tr> <td>DP 1</td> <td>√</td> <td>√</td> <td>√</td> <td>√</td> <td>√</td> </tr> <tr> <td>DP 2</td> <td>√</td> <td>√</td> <td>√</td> <td>√</td> <td>√</td> </tr> <tr> <td>HDMI 1</td> <td>√</td> <td>√</td> <td>√</td> <td>√</td> <td>√</td> </tr> <tr> <td>HDMI 2</td> <td>√</td> <td>√</td> <td>√</td> <td>√</td> <td>√</td> </tr> </tbody> </table> <p>i NOTE: For those with the same window size, you can choose to duplicate any of the input sources: Thunderbolt / DP 1 / DP 2 / HDMI 1 / HDMI 2. For configurations with different window sizes, any input sources can be selected for the Main Window (left / top / left top) and if Sub Window is of a different size, any input source can be selected for it except the same input source that has been selected for the Main Window which will be grayed out. If input source selected for Main Window is same as Sub Window, the Sub Window will auto iterate to select the next input source.</p>	Main Window (left / top / left top)	Sub (right / bottom) Window					Thunderbolt	DP 1	DP 2	HDMI 1	HDMI 2	Thunderbolt	√	√	√	√	√	DP 1	√	√	√	√	√	DP 2	√	√	√	√	√	HDMI 1	√	√	√	√	√	HDMI 2	√	√	√	√	√
Main Window (left / top / left top)	Sub (right / bottom) Window																																										
	Thunderbolt	DP 1	DP 2	HDMI 1	HDMI 2																																						
Thunderbolt	√	√	√	√	√																																						
DP 1	√	√	√	√	√																																						
DP 2	√	√	√	√	√																																						
HDMI 1	√	√	√	√	√																																						
HDMI 2	√	√	√	√	√																																						

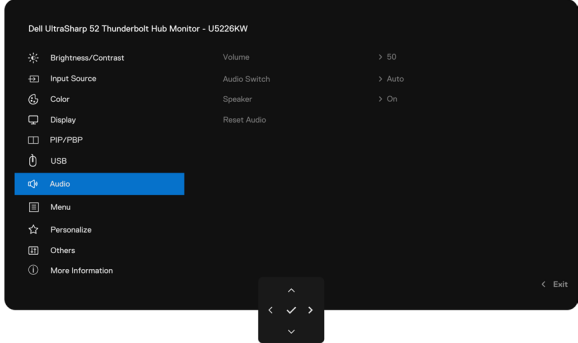
Icon	Menu and Submenus	Description																																
	PIP/PBP Mode	<p>Adjusts the PIP or PBP (Picture by Picture) mode. You can disable this feature by selecting Off.</p>  <table border="1" data-bbox="399 649 686 1792"> <thead> <tr> <th>Configuration</th> <th>Resolution/Refresh Rate</th> </tr> </thead> <tbody> <tr> <td>Configuration 1</td> <td>3072x2560@120Hz(Win1) 3072x2560@120Hz(Win2)</td> </tr> <tr> <td>Configuration 2</td> <td>4608x2560@120Hz(Win1) 1536x2560@120Hz(Win2)</td> </tr> <tr> <td>Configuration 3</td> <td>1536x2560@120Hz(Win1) 4608x2560@120Hz(Win2)</td> </tr> <tr> <td>Configuration 4</td> <td>4096x2560@120Hz(Win1) 2048x2560@120Hz(Win2)</td> </tr> <tr> <td>Configuration 5</td> <td>2048x2560@120Hz(Win1) 4096x2560@120Hz(Win2)</td> </tr> <tr> <td>Configuration 6</td> <td>6144x1280@120Hz(Win1) 6144x1280@120Hz(Win2)</td> </tr> <tr> <td>Configuration 7</td> <td>6144x853@120Hz(Win1) 6144x1707@120Hz(Win2)</td> </tr> <tr> <td>Configuration 8</td> <td>2048x2560@120Hz(Win1) 2048x2560@120Hz(Win2) 2048x2560@120Hz(Win3)</td> </tr> <tr> <td>Configuration 9</td> <td>1536x2560@120Hz(Win1) 3072x2560@120Hz(Win2) 1536x2560@120Hz(Win3)</td> </tr> <tr> <td>Configuration 10</td> <td>3072x1280@120Hz(Win1) 3072x2560@120Hz(Win2) 3072x1280@120Hz(Win3)</td> </tr> <tr> <td>Configuration 11</td> <td>3072x2560@120Hz(Win1) 3072x1280@120Hz(Win2) 3072x1280@120Hz(Win3)</td> </tr> <tr> <td>Configuration 12</td> <td>6144x1280@120Hz(Win1) 3072x1280@120Hz(Win2) 3072x1280@120Hz(Win3)</td> </tr> <tr> <td>Configuration 13</td> <td>3072x1280@120Hz(Win1) 3072x1280@120Hz(Win2) 6144x1280@120Hz(Win3)</td> </tr> <tr> <td>Configuration 14</td> <td>1536x2560@120Hz(Win1) 1536x2560@120Hz(Win2) 1536x2560@120Hz(Win3) 1536x2560@120Hz(Win4)</td> </tr> <tr> <td>Configuration 15</td> <td>3072x1280@120Hz(Win1) 3072x1280@120Hz(Win2) 3072x1280@120Hz(Win3) 3072x1280@120Hz(Win4)</td> </tr> </tbody> </table>	Configuration	Resolution/Refresh Rate	Configuration 1	3072x2560@120Hz(Win1) 3072x2560@120Hz(Win2)	Configuration 2	4608x2560@120Hz(Win1) 1536x2560@120Hz(Win2)	Configuration 3	1536x2560@120Hz(Win1) 4608x2560@120Hz(Win2)	Configuration 4	4096x2560@120Hz(Win1) 2048x2560@120Hz(Win2)	Configuration 5	2048x2560@120Hz(Win1) 4096x2560@120Hz(Win2)	Configuration 6	6144x1280@120Hz(Win1) 6144x1280@120Hz(Win2)	Configuration 7	6144x853@120Hz(Win1) 6144x1707@120Hz(Win2)	Configuration 8	2048x2560@120Hz(Win1) 2048x2560@120Hz(Win2) 2048x2560@120Hz(Win3)	Configuration 9	1536x2560@120Hz(Win1) 3072x2560@120Hz(Win2) 1536x2560@120Hz(Win3)	Configuration 10	3072x1280@120Hz(Win1) 3072x2560@120Hz(Win2) 3072x1280@120Hz(Win3)	Configuration 11	3072x2560@120Hz(Win1) 3072x1280@120Hz(Win2) 3072x1280@120Hz(Win3)	Configuration 12	6144x1280@120Hz(Win1) 3072x1280@120Hz(Win2) 3072x1280@120Hz(Win3)	Configuration 13	3072x1280@120Hz(Win1) 3072x1280@120Hz(Win2) 6144x1280@120Hz(Win3)	Configuration 14	1536x2560@120Hz(Win1) 1536x2560@120Hz(Win2) 1536x2560@120Hz(Win3) 1536x2560@120Hz(Win4)	Configuration 15	3072x1280@120Hz(Win1) 3072x1280@120Hz(Win2) 3072x1280@120Hz(Win3) 3072x1280@120Hz(Win4)
Configuration	Resolution/Refresh Rate																																	
Configuration 1	3072x2560@120Hz(Win1) 3072x2560@120Hz(Win2)																																	
Configuration 2	4608x2560@120Hz(Win1) 1536x2560@120Hz(Win2)																																	
Configuration 3	1536x2560@120Hz(Win1) 4608x2560@120Hz(Win2)																																	
Configuration 4	4096x2560@120Hz(Win1) 2048x2560@120Hz(Win2)																																	
Configuration 5	2048x2560@120Hz(Win1) 4096x2560@120Hz(Win2)																																	
Configuration 6	6144x1280@120Hz(Win1) 6144x1280@120Hz(Win2)																																	
Configuration 7	6144x853@120Hz(Win1) 6144x1707@120Hz(Win2)																																	
Configuration 8	2048x2560@120Hz(Win1) 2048x2560@120Hz(Win2) 2048x2560@120Hz(Win3)																																	
Configuration 9	1536x2560@120Hz(Win1) 3072x2560@120Hz(Win2) 1536x2560@120Hz(Win3)																																	
Configuration 10	3072x1280@120Hz(Win1) 3072x2560@120Hz(Win2) 3072x1280@120Hz(Win3)																																	
Configuration 11	3072x2560@120Hz(Win1) 3072x1280@120Hz(Win2) 3072x1280@120Hz(Win3)																																	
Configuration 12	6144x1280@120Hz(Win1) 3072x1280@120Hz(Win2) 3072x1280@120Hz(Win3)																																	
Configuration 13	3072x1280@120Hz(Win1) 3072x1280@120Hz(Win2) 6144x1280@120Hz(Win3)																																	
Configuration 14	1536x2560@120Hz(Win1) 1536x2560@120Hz(Win2) 1536x2560@120Hz(Win3) 1536x2560@120Hz(Win4)																																	
Configuration 15	3072x1280@120Hz(Win1) 3072x1280@120Hz(Win2) 3072x1280@120Hz(Win3) 3072x1280@120Hz(Win4)																																	

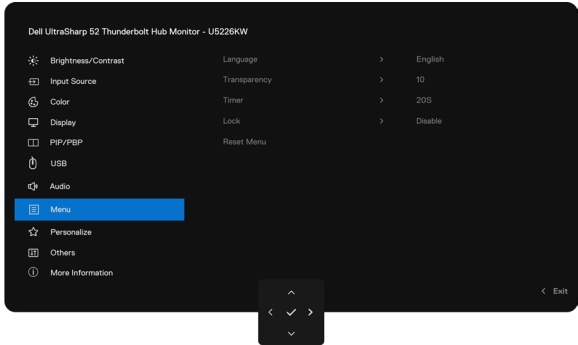
Icon	Menu and Submenus	Description																																
	Screen Partition (DP/TBT)	 <table border="1" data-bbox="399 582 662 1635"> <thead> <tr> <th>Configuration</th> <th>Resolution and Refresh Rate</th> </tr> </thead> <tbody> <tr> <td>Configuration 1</td> <td>3072x2560@120Hz(Win1) 3072x2560@120Hz(Win2)</td> </tr> <tr> <td>Configuration 2</td> <td>4608x2560@120Hz(Win1) 1536x2560@120Hz(Win2)</td> </tr> <tr> <td>Configuration 3</td> <td>1536x2560@120Hz(Win1) 4608x2560@120Hz(Win2)</td> </tr> <tr> <td>Configuration 4</td> <td>4096x2560@120Hz(Win1) 2048x2560@120Hz(Win2)</td> </tr> <tr> <td>Configuration 5</td> <td>2048x2560@120Hz(Win1) 4096x2560@120Hz(Win2)</td> </tr> <tr> <td>Configuration 6</td> <td>6144x1280@60Hz(Win1) 6144x1280@60Hz(Win2)</td> </tr> <tr> <td>Configuration 7</td> <td>6144x853@60Hz(Win1) 6144x1707@60Hz(Win2)</td> </tr> <tr> <td>Configuration 8</td> <td>2048x2560@60Hz(Win1) 2048x2560@60Hz(Win2) 2048x2560@60Hz(Win3)</td> </tr> <tr> <td>Configuration 9</td> <td>1536x2560@60Hz(Win1) 3072x2560@60Hz(Win2) 1536x2560@60Hz(Win3)</td> </tr> <tr> <td>Configuration 10</td> <td>3072x1280@60Hz(Win1) 3072x2560@60Hz(Win2) 3072x1280@60Hz(Win3)</td> </tr> <tr> <td>Configuration 11</td> <td>3072x2560@60Hz(Win1) 3072x1280@60Hz(Win2) 3072x1280@60Hz(Win3)</td> </tr> <tr> <td>Configuration 12</td> <td>6144x1280@60Hz(Win1) 3072x1280@60Hz(Win2) 3072x1280@60Hz(Win3)</td> </tr> <tr> <td>Configuration 13</td> <td>3072x1280@60Hz(Win1) 3072x1280@60Hz(Win2) 6144x1280@60Hz(Win3)</td> </tr> <tr> <td>Configuration 14</td> <td>1536x2560@60Hz(Win1) 1536x2560@60Hz(Win2) 1536x2560@60Hz(Win3) 1536x2560@60Hz(Win4)</td> </tr> <tr> <td>Configuration 15</td> <td>3072x1280@60Hz(Win1) 3072x1280@60Hz(Win2) 3072x1280@60Hz(Win3) 3072x1280@60Hz(Win4)</td> </tr> </tbody> </table> <p data-bbox="399 1646 1476 1803"> i NOTE: If the capability and bandwidth of your system's graphics card is sufficient, the monitor can reach a maximum of 4 native timing of active partition windows depending on the Screen Partition mode that is selected. Otherwise if the capability and bandwidth of the system's graphics card is not sufficient, some of the partition windows may not reach its native timing or may not light up. Please do check the system's graphics card's capability. </p>	Configuration	Resolution and Refresh Rate	Configuration 1	3072x2560@120Hz(Win1) 3072x2560@120Hz(Win2)	Configuration 2	4608x2560@120Hz(Win1) 1536x2560@120Hz(Win2)	Configuration 3	1536x2560@120Hz(Win1) 4608x2560@120Hz(Win2)	Configuration 4	4096x2560@120Hz(Win1) 2048x2560@120Hz(Win2)	Configuration 5	2048x2560@120Hz(Win1) 4096x2560@120Hz(Win2)	Configuration 6	6144x1280@60Hz(Win1) 6144x1280@60Hz(Win2)	Configuration 7	6144x853@60Hz(Win1) 6144x1707@60Hz(Win2)	Configuration 8	2048x2560@60Hz(Win1) 2048x2560@60Hz(Win2) 2048x2560@60Hz(Win3)	Configuration 9	1536x2560@60Hz(Win1) 3072x2560@60Hz(Win2) 1536x2560@60Hz(Win3)	Configuration 10	3072x1280@60Hz(Win1) 3072x2560@60Hz(Win2) 3072x1280@60Hz(Win3)	Configuration 11	3072x2560@60Hz(Win1) 3072x1280@60Hz(Win2) 3072x1280@60Hz(Win3)	Configuration 12	6144x1280@60Hz(Win1) 3072x1280@60Hz(Win2) 3072x1280@60Hz(Win3)	Configuration 13	3072x1280@60Hz(Win1) 3072x1280@60Hz(Win2) 6144x1280@60Hz(Win3)	Configuration 14	1536x2560@60Hz(Win1) 1536x2560@60Hz(Win2) 1536x2560@60Hz(Win3) 1536x2560@60Hz(Win4)	Configuration 15	3072x1280@60Hz(Win1) 3072x1280@60Hz(Win2) 3072x1280@60Hz(Win3) 3072x1280@60Hz(Win4)
Configuration	Resolution and Refresh Rate																																	
Configuration 1	3072x2560@120Hz(Win1) 3072x2560@120Hz(Win2)																																	
Configuration 2	4608x2560@120Hz(Win1) 1536x2560@120Hz(Win2)																																	
Configuration 3	1536x2560@120Hz(Win1) 4608x2560@120Hz(Win2)																																	
Configuration 4	4096x2560@120Hz(Win1) 2048x2560@120Hz(Win2)																																	
Configuration 5	2048x2560@120Hz(Win1) 4096x2560@120Hz(Win2)																																	
Configuration 6	6144x1280@60Hz(Win1) 6144x1280@60Hz(Win2)																																	
Configuration 7	6144x853@60Hz(Win1) 6144x1707@60Hz(Win2)																																	
Configuration 8	2048x2560@60Hz(Win1) 2048x2560@60Hz(Win2) 2048x2560@60Hz(Win3)																																	
Configuration 9	1536x2560@60Hz(Win1) 3072x2560@60Hz(Win2) 1536x2560@60Hz(Win3)																																	
Configuration 10	3072x1280@60Hz(Win1) 3072x2560@60Hz(Win2) 3072x1280@60Hz(Win3)																																	
Configuration 11	3072x2560@60Hz(Win1) 3072x1280@60Hz(Win2) 3072x1280@60Hz(Win3)																																	
Configuration 12	6144x1280@60Hz(Win1) 3072x1280@60Hz(Win2) 3072x1280@60Hz(Win3)																																	
Configuration 13	3072x1280@60Hz(Win1) 3072x1280@60Hz(Win2) 6144x1280@60Hz(Win3)																																	
Configuration 14	1536x2560@60Hz(Win1) 1536x2560@60Hz(Win2) 1536x2560@60Hz(Win3) 1536x2560@60Hz(Win4)																																	
Configuration 15	3072x1280@60Hz(Win1) 3072x1280@60Hz(Win2) 3072x1280@60Hz(Win3) 3072x1280@60Hz(Win4)																																	

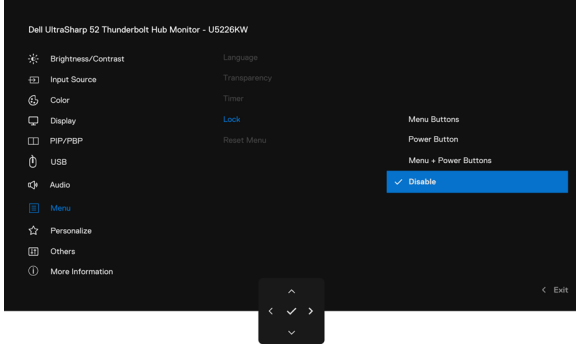
Icon	Menu and Submenus	Description												
	PBP with Screen Partition (DP/TBT)	<table border="1"> <tr> <td>PC 1 iMST Stream 1</td> <td>PC 1 iMST Stream 2</td> </tr> <tr> <td>PC 2 iMST Stream 1</td> <td>PC 2 iMST Stream 2</td> </tr> </table> <table border="1"> <tr> <td>PC1 mode 4lane iMST Stream 1</td> <td>3072x1280@120Hz</td> </tr> <tr> <td>PC1 mode 4lane iMST Stream 2</td> <td>3072x1280@120Hz</td> </tr> <tr> <td>PC2 iMST Stream 1</td> <td>3072x1280@120Hz</td> </tr> <tr> <td>PC2 iMST Stream 2</td> <td>3072x1280@120Hz</td> </tr> </table> <p>i NOTE: If the capability and bandwidth of your system's graphics card is sufficient, the monitor can reach a maximum of 4 native timing of active partition windows depending on the Screen Partition mode that is selected. Otherwise if the capability and bandwidth of the system's graphics card is not sufficient, some of the partition windows may not reach its native timing or may not light up. Please do check the system's graphics card's capability.</p>	PC 1 iMST Stream 1	PC 1 iMST Stream 2	PC 2 iMST Stream 1	PC 2 iMST Stream 2	PC1 mode 4lane iMST Stream 1	3072x1280@120Hz	PC1 mode 4lane iMST Stream 2	3072x1280@120Hz	PC2 iMST Stream 1	3072x1280@120Hz	PC2 iMST Stream 2	3072x1280@120Hz
PC 1 iMST Stream 1	PC 1 iMST Stream 2													
PC 2 iMST Stream 1	PC 2 iMST Stream 2													
PC1 mode 4lane iMST Stream 1	3072x1280@120Hz													
PC1 mode 4lane iMST Stream 2	3072x1280@120Hz													
PC2 iMST Stream 1	3072x1280@120Hz													
PC2 iMST Stream 2	3072x1280@120Hz													
	USB Switch	<p>Select to switch between the USB upstream sources in PBP mode or PBP with Screen Partition (DP/TBT). Move the joystick to switch among USB upstream sources in PBP mode or PBP with Screen Partition (DP/TBT).</p> <p>i NOTE: The feature is available only when the PIP/PBP mode is enabled or PBP with Screen Partition (DP/TBT) is On.</p>												
	Video Swap	<p>Select to swap videos between the main window and sub-window in PBP mode or between top source and bottom source in PBP with Screen Partition (DP/TBT).</p> <p>i NOTE: Video swap is only applicable for PBP mode with 2-Window configuration and PBP with Screen Partition mode.</p>												
	USB	<p>Allows you to assign the USB upstream port for the DP input signals, thus the monitor's USB downstream port (For example, keyboard and mouse) can be used by the current input signals when you connect a computer to either one of the upstream ports. When you use only one upstream port, the connected upstream port is active.</p>  <p>i NOTE: To prevent data damage or loss, before changing USB upstream ports, make sure that no USB storage devices are in use by the computer connected to the monitor's USB upstream port.</p>												
	DP 1 assign to	This option can assign the USB data of Thunderbolt (140W) , USB-C 2, USB-C 3, USB-C 4 to the DP source , so that the DP source can connect to the device of the downstream port of the monitor.												
	DP 2 assign to	This option can assign the USB data of Thunderbolt (140W) , USB-C 2, USB-C 3, USB-C 4 to the DP source , so that the DP source can connect to the device of the downstream port of the monitor.												
	HDMI 1 assign to	This option can assign the USB data of Thunderbolt (140W) , USB-C 2, USB-C 3, USB-C 4 to the HDMI source , so that the HDMI source can connect to the device of the downstream port of the monitor.												
	HDMI 2 assign to	This option can assign the USB data of Thunderbolt (140W) , USB-C 2, USB-C 3, USB-C 4 to the HDMI source , so that the HDMI source can connect to the device of the downstream port of the monitor.												
	Ethernet Switch Mode	<p>Allows you to set the Ethernet switch mode:</p> <ul style="list-style-type: none"> • Tie to KVM: When KVM USB switches, ethernet switches together. • Lock at Thunderbolt: Ethernet is always locked at Thunderbolt port. 												
	Show KVM Setup Guide	Select this option and follow steps if you want to connect multiple computers to the monitor and use one setup of keyboard and mouse.												
	Reset USB	Resets all settings under the USB menu to the factory defaults.												

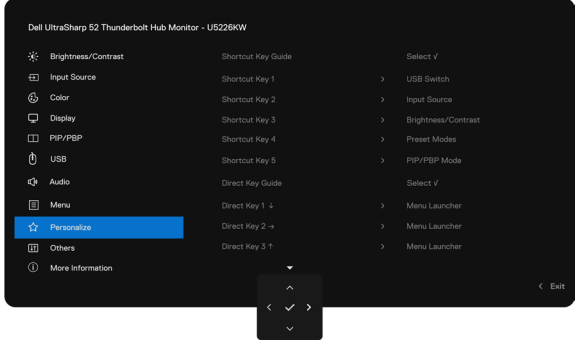
Icon	Menu and Submenus	Description
	Audio	
	Volume	Allows you to set the volume level of the headphone output. Use the joystick to adjust the volume level from 0 to 100.
	Audio Switch	Allows you to set the Audio switch mode (PIP/PBP/PBP with screen partition). <ul style="list-style-type: none"> • Auto: If window input source is inactive, the audio window auto iterate to select the next active input source window 1/2/3/4 (clockwise). • Manual: Window 1/2/3/4 audio switch by OSD audio source select.
	Speaker	Select On or Off the Speaker function.
	Reset Audio	Resets all settings under the Audio menu to the factory defaults.
	Menu	Select this option to adjust the settings of the OSD, such as the languages of the OSD, the amount of time the menu remains on screen, and so on. 
	Language	Set the OSD display to one of eight languages. (English, Spanish, French, German, Brazilian Portuguese, Russian, Simplified Chinese, or Japanese).
	Transparency	Select this option to change the menu transparency by moving the Joystick up or down (Range: 0 - 100).
	Timer	OSD Hold Time: Sets the length of time the OSD remains active after you press a button. Move the Joystick to adjust the slider in 1-second increments, from 5 to 60 seconds.

Icon	Menu and Submenus	Description
	Lock	<p>With the control buttons on the monitor locked, you can prevent people from accessing the controls. It also prevents accidental activation in multiple monitors side-by-side setup.</p>  <ul style="list-style-type: none"> • Menu Buttons: Through OSD to lock the Menu buttons. • Power Button: Through OSD to lock the Power button. • Menu + Power Buttons: Through OSD to lock the all of Menu and Power buttons. • Disable: Move the Joystick left and hold for 4 seconds.
	Reset Menu	<p>Resets all settings under the Menu to the factory defaults. Press the joystick to select this function.</p>
	Personalize	
	Shortcut Keys Guide	<p>This option allows you to easily set up to 5 shortcut keys. And contains the introduction of the shortcut key Settings.</p>
	Shortcut key 1	
	Shortcut key 2	
	Shortcut key 3	
	Shortcut key 4	<p>Select from Preset Modes, Brightness/Contrast, Auto Brightness, Auto Color Temp., Input Source, Aspect Ratio, PIP/PBP Mode, USB Switch, Video Swap, Volume, Display Info, Screen Partition (DP/TBT) set as shortcut key.</p>
	Shortcut key 5	
	Direct Keys Guide	<p>This option allows you to easily set up to 4 Direct keys. And contains the introduction of the Direct key Settings.</p>
	Direct Key 1 ↓	
	Direct Key 2 →	
	Direct Key 3 ↑	<p>Select from Off, Menu Launcher, Preset Modes, Brightness, Contrast, Input Source, Aspect Ratio, Volume, Display Info, PIP/PBP Mode, USB Switch, Video Swap set as Direct key.</p>
	Direct Key 4 ←	
	Power LED	<p>Allows you to set the state of the power light to save energy.</p>
	USB-C Charging (140W)	<p>Allows you to enable or disable USB-C Charging (140W) charging function during monitor power off mode.</p> <p> NOTE: When this function is enabled, you will be able to charge your notebook or mobile devices through the USB-C cable even when the monitor is powered off.</p>

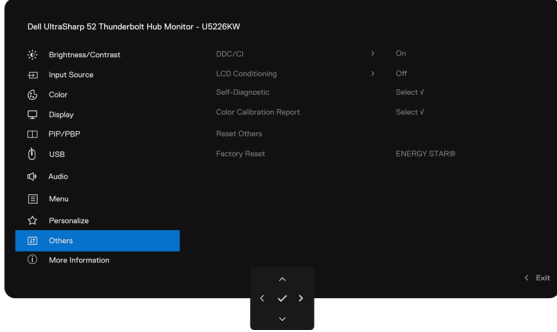
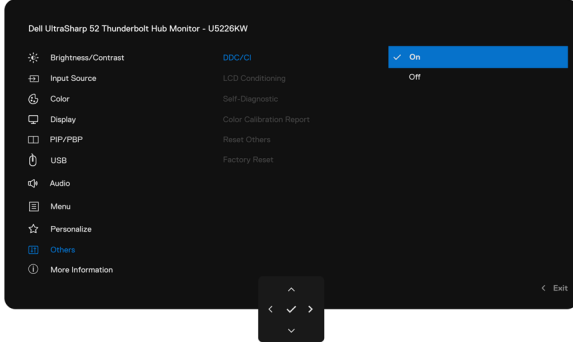
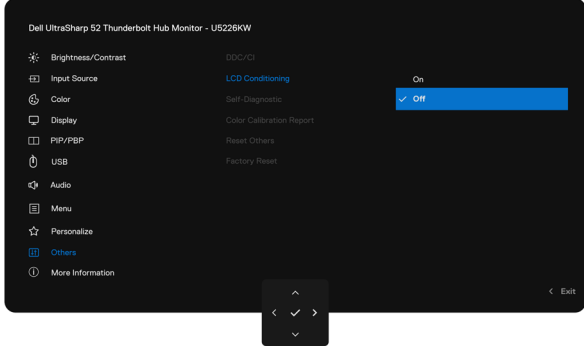
Icon	Menu and Submenus	Description
	Other USB Charging	Allows you to enable or disable Other USB Charging function during monitor Standby Mode. NOTE: When this function is enabled, you will be able to charge your mobile phone through the USB-A or USB-C cable even when the monitor is in standby mode.
	Fast Wakeup	Speed up recovery time from sleep mode.
	Reset Personalization	Resets all settings under the Personalize menu to the factory preset values. Press the joystick to select this function.
	Others	Select this option to adjust the OSD settings such as the DDC/CI, LCD Conditioning , and so on. 
	DDC/CI	DDC/CI (Display Data Channel/Command Interface) allows your monitor parameters (brightness, color balance, and etc.) to be adjustable via the software on your computer. You can disable this feature by selecting Off . Enable this feature for best user experience and optimum performance of your monitor. 
	LCD Conditioning	Helps reduce minor cases of image retention. Depending on the degree of image retention, the program may take some time to run. You can enable this feature by selecting On . 
	Self-Diagnostic	Use this option to run the built-in diagnostics, see Built-in Diagnostics .
	Color Calibration Report	Allows you to review the monitor's color data calibrated at factory product line. This includes data from four Color modes: sRGB, BT.709, DCI-P3, and Display P3. NOTE: This feature is disabled when this monitor's panel or interface board is replaced.
	Reset Others	Resets all settings under the Others menu to the factory defaults. Press the joystick to select this function.
	Factory Reset	Restores all preset values to the factory default settings. These are also the settings for ENERGY STAR® tests.

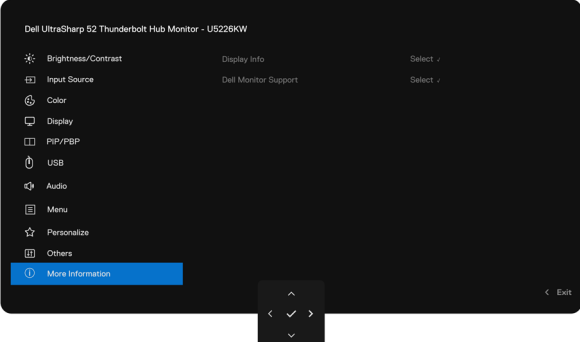
Icon	Menu and Submenus	Description
	More Information	
	Display Info	Displays the monitor's current settings. Press the joystick to select this function.
	Dell Monitor Support	You can scan the QR code for Dell Monitor Support.

Using the OSD lock function

You can lock the front-panel control buttons to prevent access to the OSD menu and/or power button.

Use the lock menu to lock the button(s)

1. Select one of the following options.

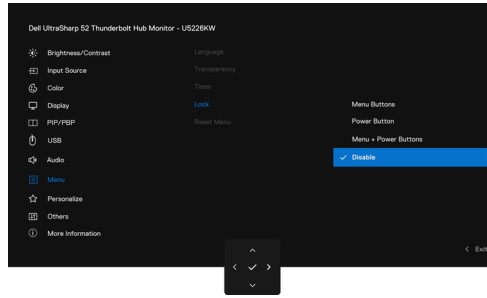

Figure 58. Select the required option to lock

The following message appears.

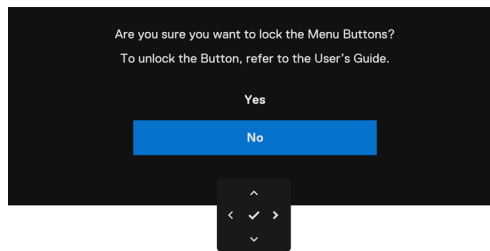

Figure 59. Lock warning message

2. Select **Yes** to lock buttons. Once locked, pressing any control button will display the lock icon .

Use the joystick to lock the button(s)

1. Press the left directional navigation of joystick for four seconds, a menu appears on the screen.

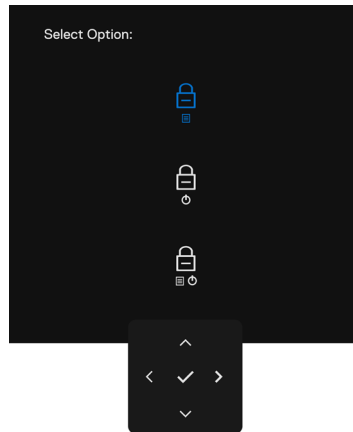





Figure 60. Lock buttons menu

2. Select one of the following options:

Table 32. Lock buttons menu description.

Options	Description
1  Menu button lock	Use this option to lock OSD menu function.
2  Power button lock	Use this option to lock power button. This will prevent the user to turn off the monitor using the power button.
3  Menu and power button lock	Use this option to lock OSD menu and power button to turn off the monitor.

Use the joystick to unlock the button(s)

Press the left directional navigation of Joystick for four seconds until a menu appears on the screen. The following table describes the options to unlock the front-panel control buttons.

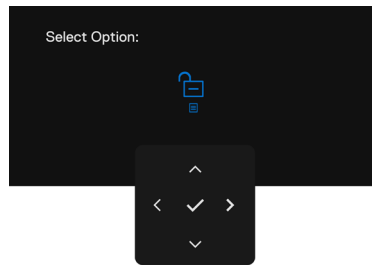





Figure 61. Unlock Menu

Table 33. Unlock menu description.

Options	Description
1  Menu button unlock	Use this option to unlock OSD menu function.
2  Power button unlock	Use this option to unlock power button to turn off the monitor.
3  Menu and power button unlock	Use this option to unlock OSD menu and power button to turn off the monitor.

Initial Setup

Select OSD items of **Factory Reset** in Other feature, the following message appears:

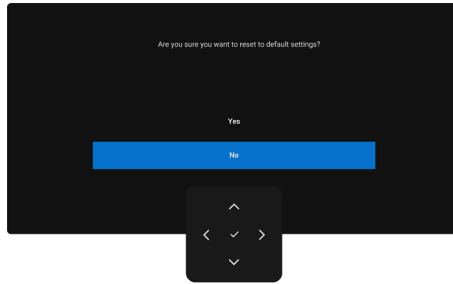

Figure 62. Reset to default settings

When you select **Yes** to reset to default settings, the following messages appear:

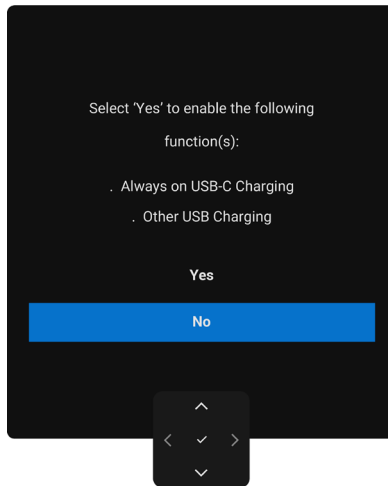

Figure 63. Reset to default settings

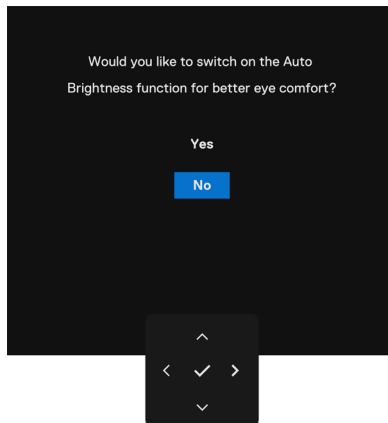

Figure 64. Auto Brightness function settings

OSD warning messages

When the monitor does not support a particular resolution mode, you can see the following message:

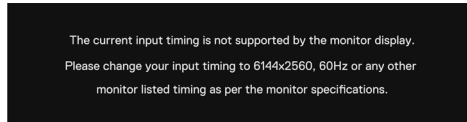

Figure 65. Does not support a particular resolution mode

This means that the monitor cannot synchronize with the signal that it is receiving from the computer. See [Monitor specifications](#) for the Horizontal and Vertical frequency ranges addressable by this monitor. Recommended mode is **6144 x 2560**.

You can see the following message before the DDC/CI function is disabled:

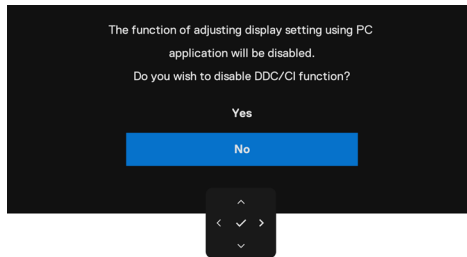

Figure 66. DDC/CI warning message

When the monitor enters the **Standby Mode**, the following message appears:

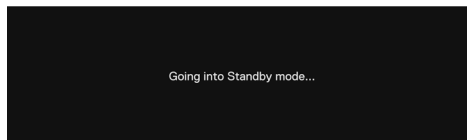

Figure 67. Standby mode warning message

Activate the computer and wake up the monitor to gain access to the [OSD](#).

If you press any button other than the power button, the following messages appears depending on the selected input:

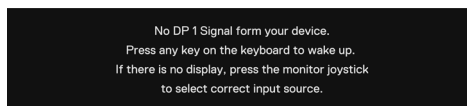

Figure 68. Warning message-wake up

A message is displayed while the cable supporting DisplayPort Alt mode is connected to the monitor under the following conditions:

- When Auto Select for **Thunderbolt (140W)** is set to **Prompt for Multiple Inputs**.
- When the Thunderbolt cable is connected to the monitor.

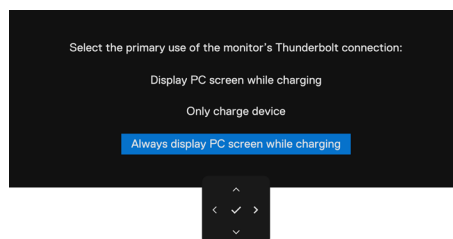

Figure 69. Warning message-Auto Select for Thunderbolt (140W)

If the monitor connects with two ports or more, when the **Auto** Input Source is selected, it will turn to the next port with signal.

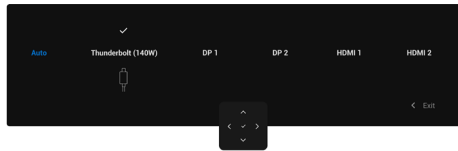

Figure 70. Auto Select Input Source

Select OSD items of **On in Standby Mode** in **Personalize** feature, the following message appears:

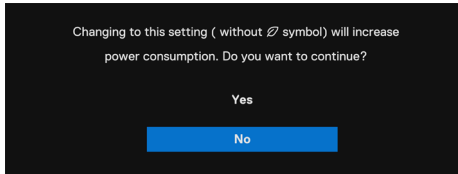

Figure 71. Warning message_Off in standby Mode

If you adjust the **Brightness** level above the default level over 75%, the following message appears:

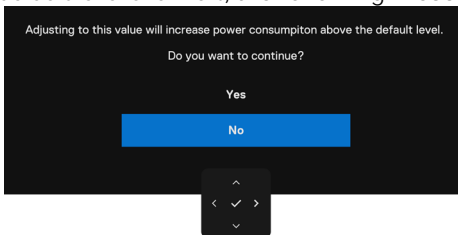

Figure 72. Warning message-Brightness level adjust

- When you select **Yes**, the power message is displayed only once.
- When you select **No**, the power warning message will pop-up again.
- The power warning message appears again only when you perform a **Factory Reset** from the OSD menu.

When **Auto Brightness** is on, if you adjust the brightness level, the following message appears:

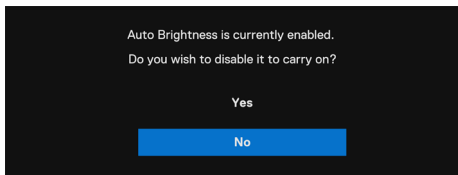

Figure 73. Warning message_Auto Brightness

If either DisplayPort 1, DisplayPort 2, HDMI 1, HDMI 2 or Thunderbolt (140W) input is selected and the corresponding cable is not connected, a floating dialog box as shown below appears.

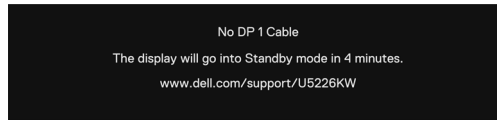

Figure 74. Warning message-no DP 1 cable

or

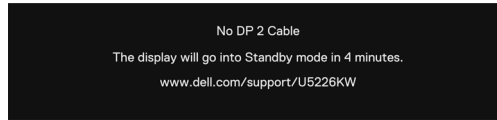

Figure 75. Warning message-no DP 2 cable

or

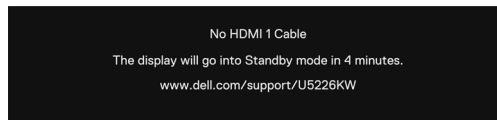

Figure 76. Warning message-no HDMI 1 cable

or

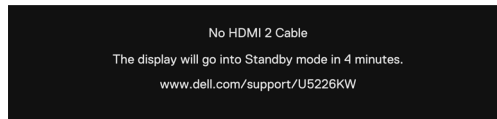

Figure 77. Warning message-no HDMI 2 cable

or

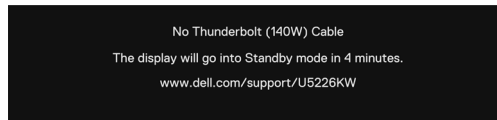

Figure 78. Warning message-no Thunderbolt(140W) cable

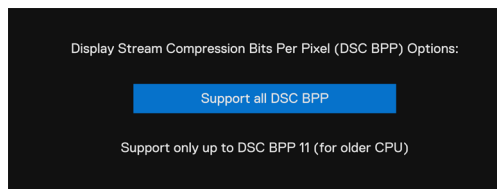

Figure 79. Warning message-DSC BPP switch function*

* If your system is running on some older generations of CPUs, you might experience no display on screen when the resolution is set to 6144 x 2560@120 Hz when connected via Thunderbolt. You could navigate to **Thunderbolt (140W)** under **Input Source** in OSD menu and press and hold the joystick for 8 seconds. A pop-up window will appear and please switch to "Support only up to DSC BPP 11 (for older CPU)".

See [Troubleshooting](#) for more information.

Setting the maximum resolution

i **NOTE:** The steps may vary slightly depending on the version of Windows you have.

To set the maximum resolution for the monitor:

In Windows 10 and Windows 11:

1. Right-click the desktop and click **Display Settings**.
2. If you have more than one monitor connected, ensure that you select **U5226KW**.
3. Click the **Display Resolution** dropdown list and select **6144 x 2560**.
4. Click **Keep changes**.

If you do not see **6144 x 2560** as an option, you must update your graphics driver to the latest version. Depending on your computer, complete one of the following procedures:

If you have a Dell desktop or laptop:

- Go to [Dell Support Site](#), enter your service tag, and download the latest driver for your graphics card.

If you are using a non-Dell computer (laptop or desktop):

- Go to the support site for your computer and download the latest graphic drivers.
- Go to your graphics card website and download the latest graphic drivers.

Setting the KVM USB Switch

To set the KVM USB Switch as Shortcut Key for the monitor:

1. Press the Joystick button to launch the OSD main menu.
2. Move the Joystick to select **Personalize**.

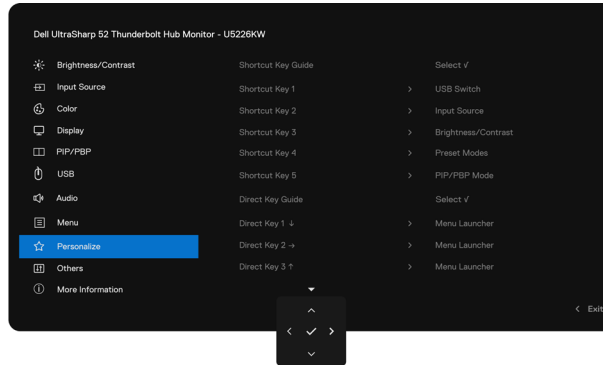

Figure 80. OSD-Personalize

3. Move the Joystick right to activate the highlighted option.
4. Move the Joystick right to activate the **Shortcut Key 1** option.
5. Move the Joystick up or down to select **USB Switch**.

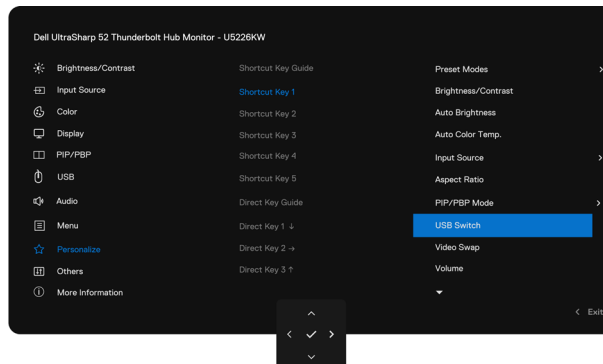

Figure 81. OSD-Personalize_Shortcut Key 1

6. Press the Joystick to confirm selection.

NOTE: KVM USB Switch function only work under PBP/PIP Mode and PBP with Screen Partition(DP/TBT)

The following are illustrations of several connection scenarios and their USB Selection menu settings, as illustrated in corresponding color frames.

1. When connecting **HDMI + USB Type-A to USB-C** to computer 1 and **DP + USB-C to C** to computer 2:

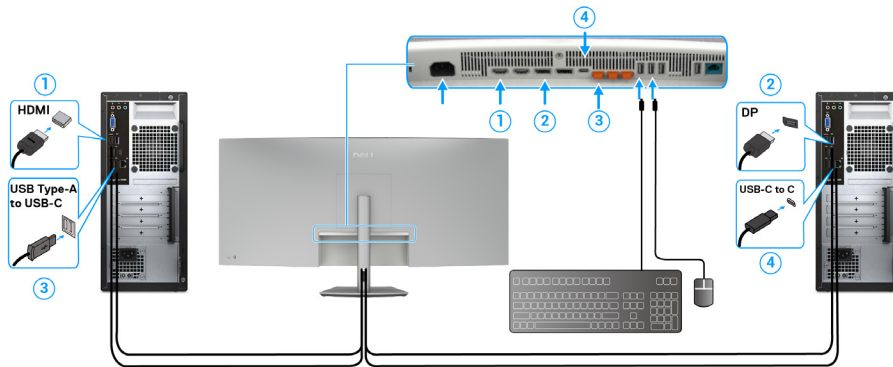

Figure 82. KVM 1 connecting

i NOTE: The USB-C connection currently supports only data transfer.

Ensure USB selection for **HDMI** is set to **USB-C 2** and **DP1** is set to **Thunderbolt (140 W)**.

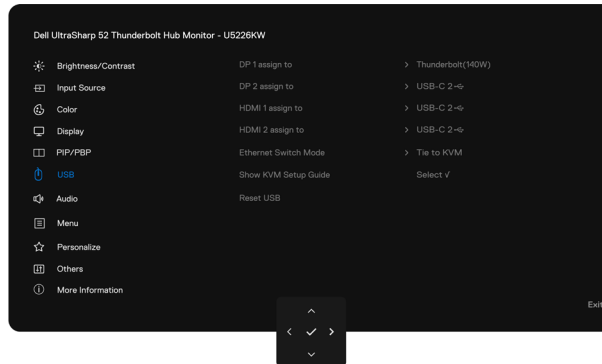

Figure 83. OSD-USB

2. When connecting **HDMI + USB Type-A to USB-C** to computer 1 and **Thunderbolt 4** to computer 2:

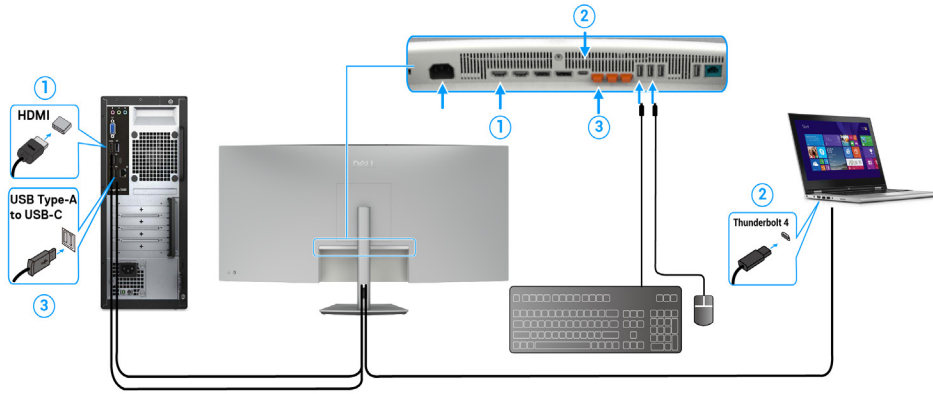

Figure 84. KVM 2 connecting

- NOTE:** The USB-C connection currently supports video and data transfer. Ensure **USB Selection** for **HDMI** is set to **USB-C 2**.

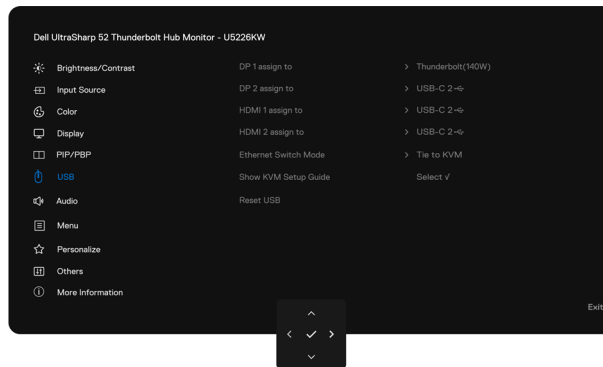

Figure 85. OSD-USB

- NOTE:** As the **Thunderbolt (140 W)** port supports the **DisplayPort Alternate Mode**, there is no need to set **USB Selection for Thunderbolt (140 W)**.
- NOTE:** When connecting to different video input sources not shown above, follow the same method to make correct settings for **USB Selection** to pair the ports.
- NOTE:** The built-in **KVM switch** allows you to control up to 4 computers from a single set of keyboard and mouse connected to the monitor.

Setting the Auto KVM

You can follow below instruction to set up Auto KVM for your monitor:

1. Ensure that **PBP Mode** is **Off**.

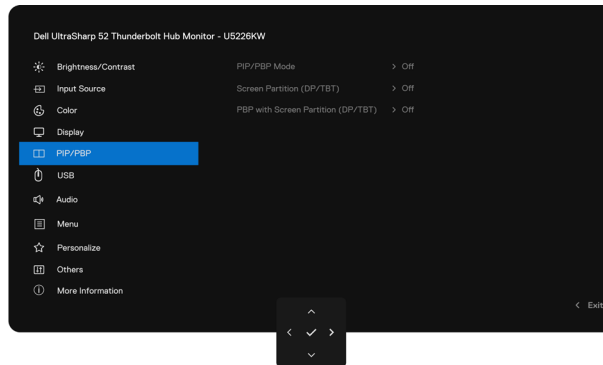

Figure 86. OSD-PIP_PBP

2. Ensure that **Auto Select** is **On** and **Auto Select for Thunderbolt** is **Yes**.

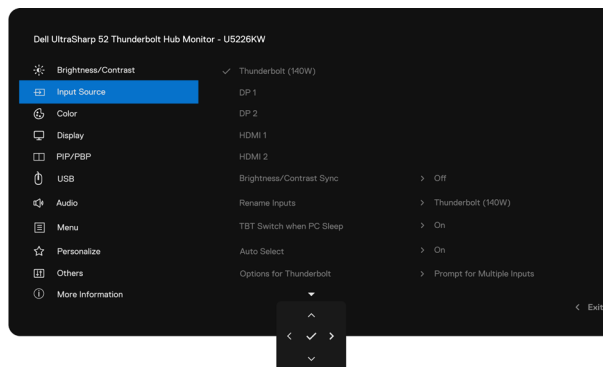

Figure 87. OSD-Input Source

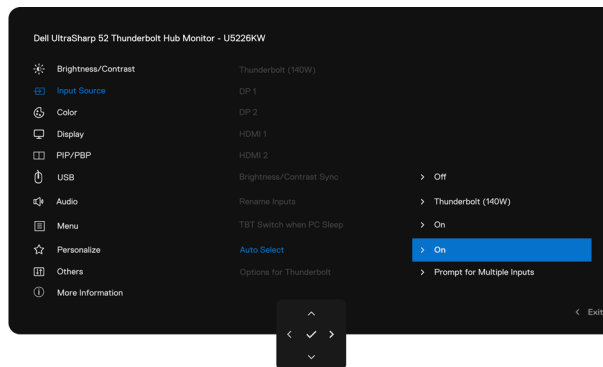

Figure 88. OSD-Input Source_Auto Select for Thunderbolt

3. Ensure that the USB ports and the video inputs are paired accordingly.

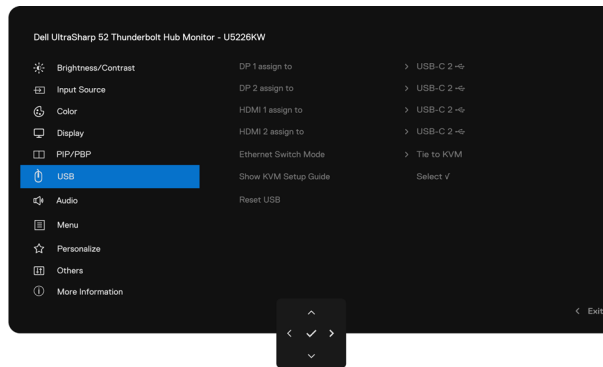

Figure 89. OSD-USB

NOTE: For Thunderbolt connection, there is no further setting required.

Troubleshooting

⚠ WARNING: Before you begin any of the procedures in this section, follow the [Safety instructions](#).

Self-test

Your monitor provides a self-test feature that allows you to check whether your monitor is functioning properly. If your monitor and computer are properly connected but the monitor screen remains dark, run the monitor self-test by performing the following steps:

1. Turn off both your computer and the monitor.
2. Unplug the video cable from the back of the computer. To ensure proper Self-Test operation, remove all digital and the analog cables from the back of computer.
3. Turn on the monitor.

The floating dialog box should appear on-screen (against a black background), if the monitor cannot sense a video signal and is working correctly. While in self-test mode, the power LED remains white. Also, depending upon the selected input, one of the dialogs shown below will continuously scroll through the screen.

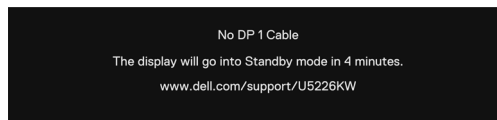

Figure 90. Warning message-no DP 1 cable

or

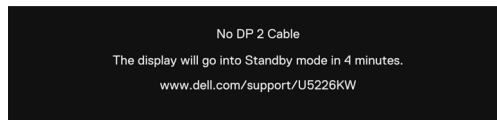

Figure 91. Warning message-no DP 2 cable

or

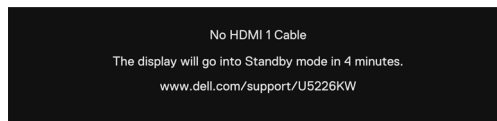

Figure 92. Warning message-no HDMI 1 cable

or

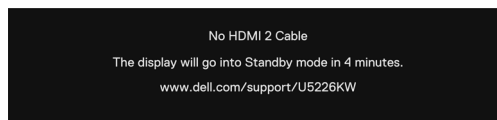

Figure 93. Warning message-no HDMI 2 cable

or

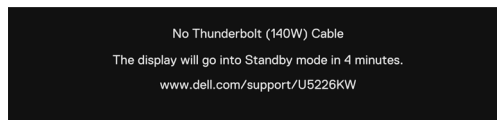

Figure 94. Warning message-no Thunderbolt (140w) cable

4. This dialog box also appears during normal operation, if the video cable is disconnected or damaged.
5. Turn off your monitor and reconnect the video cable; then turn on both your computer and the monitor.

If your monitor screen remains blank after you use the previous procedure, check your video controller and computer, because your monitor is functioning properly.

Built-in diagnostics

Your monitor has a built-in diagnostic tool that helps you determine if the screen abnormality you are experiencing is an inherent problem with your monitor, or with your computer and video card.

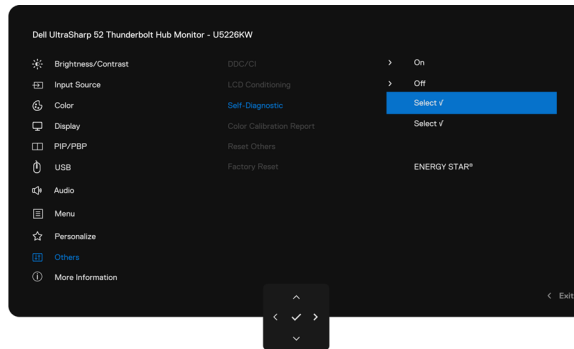

Figure 95. OSD-Others_Self-Diagnostic

To run the built-in diagnostics:

1. Ensure that the screen is clean (no dust particles on the surface of the screen).
2. Select OSD items of **Self-Diagnostics** in **Others** feature.
3. Press the Joystick button to start the diagnostics. A gray screen is displayed.
4. Observe if the screen has any defects or abnormalities.
5. Toggle the Joystick once again until a red screen is displayed.
6. Observe if the screen has any defects or abnormalities.
7. Repeat steps 5 and 6 until the screen displays green, blue, black, and white colors. Note any abnormalities or defects.

The test is complete when a text screen is displayed. To exit, toggle the Joystick control again.

If you do not detect any screen abnormalities upon using the built-in diagnostic tool, the monitor is functioning properly. Check the video card and computer.

Common problems

The following table contains general information about common monitor problems you might encounter and the possible solutions:

⚠ WARNING: The monitor LCD panel duty cycle is designed for 18 hours a day, 7 days a week. Usage higher than the designed duty cycle may result in premature decrease in panel backlight luminance, which may not be covered under warranty.

Table 34. Common problems

Common symptoms	What you experience	Possible solutions
No Video/Power LED off	No picture	<ul style="list-style-type: none"> Ensure that the video cable connecting the monitor and the computer is properly connected and secure. Verify that the power outlet is functioning properly using any other electrical equipment. Ensure that you have pressed the power button properly. Ensure that the correct input source is selected in the Input Source menu.
No video/Power LED on	No picture or no brightness	<ul style="list-style-type: none"> Increase brightness and contrast controls through OSD. Perform monitor self-test feature check. Check for bent or broken pins in the video cable connector. Run the built-in diagnostics, For more information, see Self-Diagnostic. Ensure that the correct input source is selected in the Input Source menu.
Missing pixels	LCD screen has spots	<ul style="list-style-type: none"> Cycle power on-off. Pixel that is permanently off is a natural defect that can occur in LCD technology. For more information on Dell Monitor Quality and Pixel Policy, see www.dell.com/pixelguidelines
Stuck-on pixels	LCD screen has bright spots	<ul style="list-style-type: none"> Cycle power On-Off. Pixel that is permanently off is a natural defect that can occur in LCD technology. For more information on Dell Monitor Quality and Pixel Policy, see www.dell.com/pixelguidelines
Brightness problems	Picture too dim or too bright	<ul style="list-style-type: none"> Reset the monitor to factory settings. Adjust brightness and contrast controls through OSD.
Safety related issues	Visible signs of smoke or sparks	<ul style="list-style-type: none"> Do not perform any troubleshooting steps. Contact Dell immediately.
Intermittent problems	Monitor malfunctions on and off	<ul style="list-style-type: none"> Ensure that the video cable connecting the monitor to the computer is connected properly and is secure. Reset the monitor to factory settings. Perform monitor self-test feature check to determine if the intermittent problem occurs in self-test mode.
Missing color	Picture missing color	<ul style="list-style-type: none"> Perform monitor self-test. Ensure that the video cable connecting the monitor to the computer is connected properly and is secure. Check for bent or broken pins in the video cable connector.
Wrong color	Picture color not good	<ul style="list-style-type: none"> Try different Preset Modes in Color settings OSD. Adjust R/G/B value under Custom Color in Color menu OSD. Change the Input Color Format to RGB or YCbCr in the Color settings OSD. Run the built-in diagnostics.
Image retention from a static image left on the monitor for a long period of time	Faint shadow from the static image displayed appears on the screen	<ul style="list-style-type: none"> Set the screen to turn off after a few minutes of screen idle time. These can be adjusted in Windows Power Options or Mac Energy Saver setting. Alternatively, use a dynamically changing screensaver.

Product-specific problems

Table 35. Product-specific problems

Specific symptoms	What you experience	Possible solutions
The screen image is too small	Image is centered on screen, but does not fill entire viewing area	<ul style="list-style-type: none"> • Check the Aspect Ratio setting in the Display menu OSD. • Reset the display to factory settings.
Cannot adjust the monitor with the joystick control on the rear of the monitor	OSD does not appear on the screen	<ul style="list-style-type: none"> • Turn off the monitor, unplug the monitor power cable, plug it back, and then turn on the monitor. • Check whether the OSD menu is locked. If yes, move and hold the joystick forward/back/left/right for 4 seconds to unlock.
No input signal when user controls are pressed	No picture, the LED light is white	<ul style="list-style-type: none"> • Check the signal source. Ensure that the computer is not in the power saving mode by moving the mouse or pressing any key on the keyboard. • Check whether the signal cable is plugged in properly. Connect the signal cable again, if necessary. • Reset the computer or video player.
The picture does not fill the entire screen	The picture cannot fill the height or width of the screen	<ul style="list-style-type: none"> • Due to different video formats (aspect ratio) of DVDs, the monitor may display in full screen. • Run the built-in diagnostics.
No image when using DP connection to the PC	Black screen	<ul style="list-style-type: none"> • Verify which DP standard (DP 1.1a or DP 1.4) is your Graphics Card certified to. Download and install the latest graphics card driver. • Some DP 1.1a graphics card cannot support DP 1.4 monitors.
No image when using Thunderbolt 4 connection to computer, laptop, and so on	Black screen	<ul style="list-style-type: none"> • Verify if the Thunderbolt 4 interface of the device can support DP alternate mode. • Verify if the device required more than 140 W power charging. • Thunderbolt 4 interface of device cannot support DP alternate mode. • Set Windows to Projection mode. • Ensure that the Thunderbolt 4 cable is not damaged.
No charging when using Thunderbolt 4 connection to computer, laptop, and so on	No charging	<ul style="list-style-type: none"> • Verify if the device can support one of 5 V / 9 V / 15 V / 20 V / 28 V charging profiles. • Verify if the Notebook requires a >140 W power adaptor. • If the Notebook requires a >140 W power adaptor, it may not charge with the Thunderbolt 4 connection. • Ensure that you use only Dell approved adapter or the adapter that comes with the product. • Ensure that the Thunderbolt 4 cable is not damaged.
Intermittent charging when using Thunderbolt 4 connection to computer, laptop, and so on	Intermittent charging	<ul style="list-style-type: none"> • Check if the maximum power consumption of device is over 140 W. • Ensure that you use only Dell approved adapter or the adapter that comes with the product. • Ensure that the Thunderbolt 4 cable is not damaged.
Ethernet port (RJ45) cannot connect to internet	Ethernet port (RJ45) cannot connect to internet on Win 10 / Win 11	<ul style="list-style-type: none"> • Change the LAN Controller Power Saving from Enable to Disable

Specific symptoms	What you experience	Possible solutions
The LAN port is not functioning	OS setting or cable connection issue	<ul style="list-style-type: none"> • Ensure that the latest BIOS and drivers for your computer are installed on your computer. • Ensure that the RealTek 2.5 G Ethernet Controller is installed in the Windows Device Manager. • If your BIOS Setup has a LAN/GBE Enabled/ Disabled option, make sure it is set to Enabled. • Ensure that the Ethernet cable is connected securely on the monitor and the hub/router/ firewall. • Check the status LED of the Ethernet cable to confirm connectivity. Re-connect both ends of the Ethernet cable if the LED is not lit. • First power off the Computer and unplug the Thunderbolt 4 cable and power cord of the monitor. Then, power on the computer, plug in the monitor power cord and Thunderbolt 4 cable.
Ambient light detection abnormally	When Auto Brightness is on, the detected ambient light drops significantly	<ul style="list-style-type: none"> • Check whether an object is obstructing the sensor area. • Ensure a webcam is not mounted over the sensor area. • Wipe clean any dust that may be covering the sensor area. • Ensure the display is not pivoted and placed to another monitor side-by-side.
When OSD select the Screen Partition (DP/ Thunderbolt) configurations, One or two window split screens have no video or cannot reach the maximum resolution or refresh rate	Windows not set to second screen only or GFX capability not enough	<ul style="list-style-type: none"> • Check the GFx capability of your PC/System. • Set Windows to second screen only mode.
When resolution set to 6144 x 2560@120 Hz, the monitor will black screen via Thunderbolt 4 port	Connect the monitor with Thunderbolt 4 cable to the platform, when resolution set to 6144 x 2560@120 Hz, the monitor will black screen after a) platform restart. hibernate / wake, shutdown / power up, System User sign out / sign In or resolution switching, Display mode switching. b) monitor DC/AC off / on, cable unplug / plug or platform sleep / wake.	<ul style="list-style-type: none"> • Navigate to Thunderbolt (140W) under Input Source in OSD menu and press and hold the joystick for 8 seconds. A pop-up window will appear and please switch to "Support only up to DSC BPP 11 (for older CPU)".

Universal Serial Bus (USB) specific problems

Table 36. Universal Serial Bus (USB) specific problems

Specific symptoms	What you experience	Possible solutions
USB interface is not working	USB peripherals are not working	<ul style="list-style-type: none"> • Check that your display is turned ON. • Reconnect the upstream cable to your computer. • Reconnect the USB peripherals (downstream connector). • Switch off and then turn on the display again. • Reboot the computer. • Some USB devices like external portable HDD require higher electric current; connect the device directly to the computer system.
SuperSpeed USB 3.2 interface is slow	SuperSpeed USB 3.2 peripherals working slowly or not working at all	<ul style="list-style-type: none"> • Check that your computer is USB 3.2-capable. • Some computers have USB 3.1, USB 3.0, USB 2.0, and USB 1.1 ports. Ensure that the correct USB port is used. • Reconnect the upstream cable to your computer. • Reconnect the USB peripherals (downstream connector). • Reboot the computer.
Wireless USB peripherals stop working when a USB 3.2 device is plugged in	Wireless USB peripherals responding slowly or only working as the distance between itself and its receiver decreases	<ul style="list-style-type: none"> • Increase the distance between the USB 3.2 peripherals and the wireless USB receiver. • Position your wireless USB receiver as close as possible to the wireless USB peripherals. • Use a USB-extender cable to position the wireless USB receiver as far away as possible from the USB 3.2 port.
USB is not working	No USB functionalities	<ul style="list-style-type: none"> • See the input source and USB pairing table.

Regulatory information

TCO Certified

Any Dell product bearing a TCO label has been certified to a TCO voluntary environmental certification. TCO certification requirements focus on features that contribute to a healthy work environment such as recyclable design, energy efficiency, ergonomics, emissions, avoidance of hazardous substances, and product take back.

For more information on your Dell product and the TCO certification, please visit: Dell.com/environment/TCO_Certified.

For more information on TCO's environmental certifications, please visit: tcocertified.com.

FCC notices (U.S. only) and other regulatory information

For FCC notices and other regulatory information, see the regulatory compliance website at [Dell Regulatory Compliance Home Page](#).

EU product database for energy label and product information sheet

U5226KW: <https://eprel.ec.europa.eu/qr/2415042>

U5226KW WOST: <https://eprel.ec.europa.eu/qr/2448748>

Contacting Dell

To contact Dell for sales, technical support, or customer service issues, see [Contact Support](#) at Dell Support Site.

 **NOTE:** Availability varies by country and product, and some services may not be available in your country.

 **NOTE:** If you do not have an active Internet connection, you can find contact information about your purchase invoice, packing slip, bill, or Dell product catalog.

Revision History

The following table provides the revision history of this document:

Table 37. Revision history

Revision	Date	Description
A00	January 2026	Original publish date